

# AKR 550



## USER MANUAL

# CONTENTS

I. INTRODUCTION	4
II. DIRECTION FOR USE	6
1. Intended use	7
a. Intended purpose	7
b. Indications for use	7
2. Expected clinical benefit	7
3. Contraindications	7
4. Side effects	7
5. Intended population	7
6. Intended users	7
III. CAUTIONS AND WARNINGS	8
1. Definitions	9
2. Product safety	9
a. Labels on the device	9
b. Precautions on IT Network	10
IV. PRODUCT DESCRIPTION	11
1. Product plan with description	12
a. Product	12
b. Bottom of the monitor	12
c. Joystick	13
d. Patient environment	13
e. Classification of device	14
2. List of accessories	14
V. OPERATING INFORMATION	16
1. Installation of the device	17
a. Unpacking method of internal packing box	17
b. Connection / Wiring	18
VI. USE OF THE DEVICE	19
1. Measurement flow	20
2. Preparation	20
a. Preparation for measurement	20
b. Power distribution	21
c. Standby	21
d. Preparation of examinee	22
3. Alignment	23
a. In case of [Auto Quick] or [Auto]	23
b. In case of [Manual]	25
4. Tips for effective measurement	26
5. Measurement	26
6. Print-out of measurement result	27
7. Handling after measurement	30
8. Setting of [Setup] screen	30
a. [Number]	32
b. [Language]	33
c. [Customize]	33

d. [Date form]	34
e. [Message]	34
f. [Default setting]	35
9. Scotopic Pupil Size (SPS) - Measurement function	35
10. IOL measurement function	36
11. Low reliability mark display function	37
12. Output	37
13. Data screen function	38
14. Power saving function	39
15. Contact lens: measurement of base curve	40
<b>VII. MAINTENANCE</b>	<b>41</b>
1. Storage and handling condition	42
a. Conveyance	42
b. Reload of printer paper	43
c. Fuse replacement	43
d. Setting of chinrest liner	44
e. Storage of device	44
f. Confirmation of measurement accuracy	45
2. Cleaning instructions	45
3. Periodical inspection and maintenance	46
<b>VIII. ERROR AND TROUBLESHOOTING</b>	<b>47</b>
1. Error display	48
2. Troubleshooting	49
<b>IX. TECHNICAL DESCRIPTION</b>	<b>50</b>
1. Technical data	51
a. Product life-time	51
b. Disposal	51
c. Product weight & dimensions	51
d. Precise performances as intended by Essilor	51
e. Precise performances accuracy / function	53
2. Electromagnetic compatibility	54
3. IT requirements	56
<b>X. SYMBOL EXPLANATION</b>	<b>57</b>
1. On the document	58
2. On the device	58
3. On the packaging	59
<b>XI. EXCLUSION OF LIABILITY</b>	<b>60</b>
<b>XII. QR CODE</b>	<b>62</b>
<b>XIII. CONTACT INFORMATION</b>	<b>66</b>

# I. INTRODUCTION

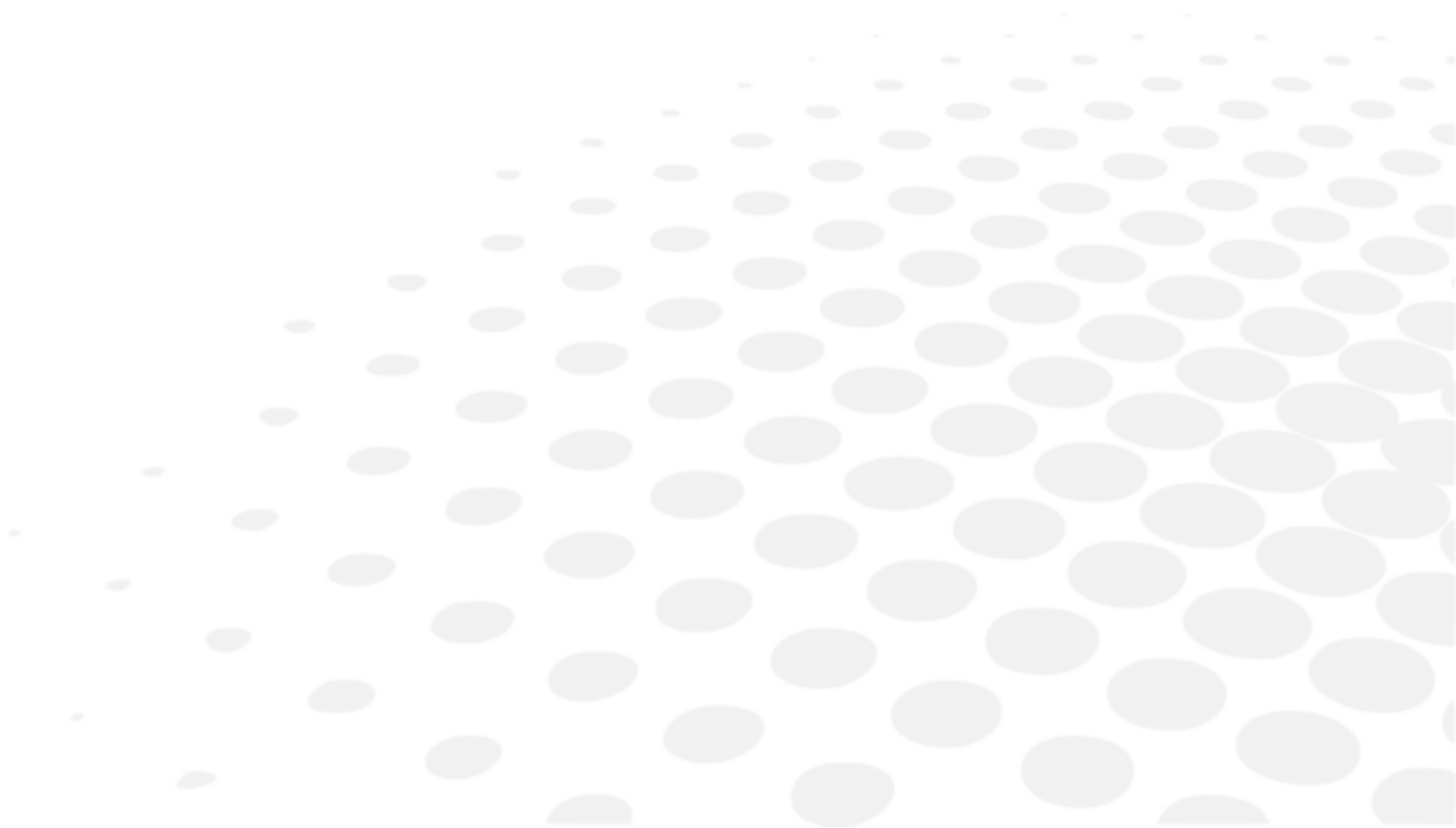



The latest version of this user manual is available on a web space.  
To access other available languages, please scan the QR code available at the end of this user manual > QR Code Chapter (p.62).

For a safer, more effective use, follow the instructions outlined in this manual.

Copyright © 2025 Essilor - Original manual - All rights reserved.

Essilor International

147 rue de Paris, 94220, CHARENTON-LE-PONT

[www.essilor.com](http://www.essilor.com)

All reproduction of the content of this document, whether in part or as a whole, for the purpose of its publication or dissemination by any means and in any format whatsoever, even free of charge, is strictly prohibited without Essilor's prior written consent.

## II. DIRECTION FOR USE



## 1. Intended use

### **a. Intended purpose**

AKR 550 is intended to objectively measure the refractive power of the eye and to measure the corneal curvature radius.

### **b. Indications for use**

AKR 550 is intended for use in cases of ametropia and for routine checks by the eye care professional.

## 2. Expected clinical benefit

To benefit from a prescription for a compensation solution (refractive power) in agreement with the state-of-the-art vision care.

To benefit from a prescription for a compensation solution (contact lens curvature) in agreement with the state-of-the-art vision care.

## 3. Contraindications

No known contraindications.

## 4. Side effects

There are no known side-effects.

Please report any serious incident that occurred in relation to the device to [essilor-instruments-vigilance@essilor.com](mailto:essilor-instruments-vigilance@essilor.com) and to the local competent authority for medical devices.

## 5. Intended population

Adults and children who may require the application of a visual compensation.



## 6. Intended users

Eye care professional use only.

### **III. CAUTIONS AND WARNINGS**



## 1. Definitions

SYMBOL	DESCRIPTION
	Caution: a hazardous situation that, if not avoided, could result in minor or moderate injury.
	Warning: a hazardous situation that, if not avoided, could result in death or serious injury.
	Important and/or useful additional information to learn relating to the text in this manual.



This manual includes the information about basic operation, inspection and maintenance of AKR 550. This device and the contents of this manual comply with IEC60601-1.

The current version of the product software is V1.



- The device complies with ISO 10342:2010 subclause 4 (Ophthalmic instruments - Eye Refractometers) and ISO 10343:2014 subclause 4 (Ophthalmic instruments - Ophthalmometers).
- The dioptric powers are indicated with reference wavelength  $\lambda_d = 587.56 \text{ nm}$ .



- The safety precautions and operating procedures must be thoroughly understood prior to operation of the device.

## 2. Product safety



### a. Labels on the device

The warning labels are placed on this product for ensuring safe use.

Follow the indicated description, and use this product properly.

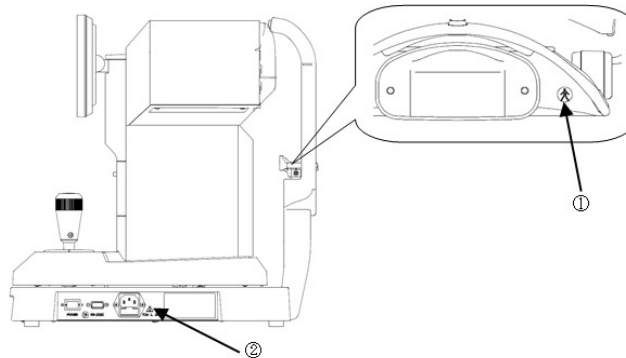
If any of the following labels are missing, contact your local distributor or business contact.



	Degree of protection against electrical shock : Type B Equipment (IEC 60601-1)
	Warning: Before any fuse replacement, disconnect the power cord from the main unit, and replace it with the specified fuse. It can result in injury or fire due to electric shock.

## b. Precautions on IT Network



- When connecting to an IT network, ensure appropriate and adequate security to prevent infection by computer viruses and leakage of information.
  - In the event of a malfunction in IT systems, several problems may occur.
    - Software updates fail due to poor communication (RS232C). This prevents the device from being used and therefore the inspection cannot continue.
    - Poor communication (RS232C) prevents output of measurement result data.
  - This may result in loss of data.
  - Connection of this device to an IT network that includes other equipment could result in previously unidentified risks to patients, operators or third parties.
  - Subsequent changes to the IT network could introduce new risks and require additional analysis
- This device can output the data to PC and so on through RS232C interface.
  - Refer to the figure below for the characteristics, configuration, technical specification, intended information flow and route when connected with an IT network.
  - The responsible organization should identify, analyze, evaluate and control these risks.
  - Changes to the IT network include:
    - Changes in the IT network configuration
    - Connection of additional items to the IT network
    - Disconnecting items from the IT network
    - Update of equipment connected to the IT network, and
    - Upgrade of equipment connected to the IT network

Please contact your distributor about the detail of this device.

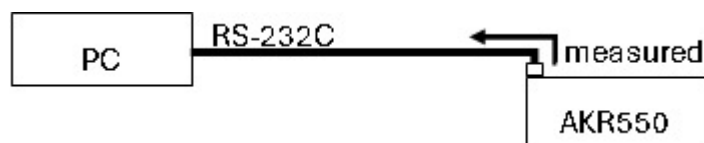

## IV. PRODUCT DESCRIPTION



This product (AKR 550) aims to objectively measure the refractive power of the eye by using the light that is projected to and reflected from the eyeground. It also aims to measure the radius of corneal curvature by using the light that is projected to and reflected from the cornea.

As the feature of this device, the LCD is tilted to the vertical direction and horizontal direction so that the angle can be adjusted.

## 1. Product plan with description

### a. Product

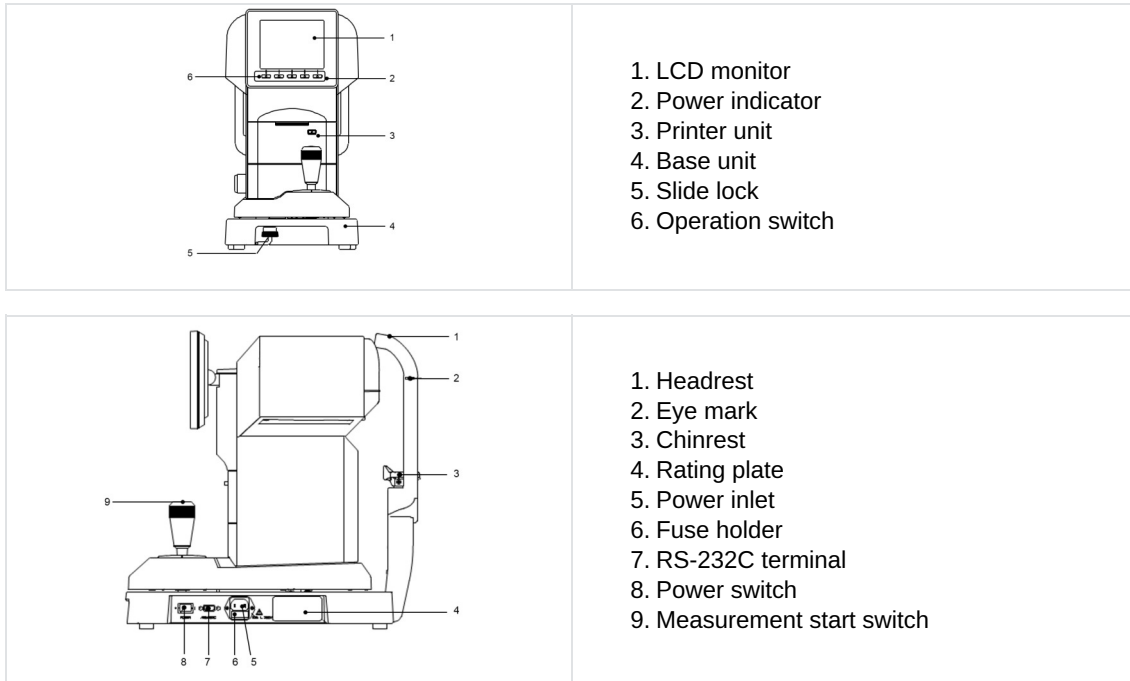

Applied parts are headrest and chinrest.



There is the parts list separated from this manual.

### b. Bottom of the monitor

The operation switches under the monitor correspond to the icons displayed on the bottom of the monitor.

For usual measurement, the operating switches correspond to the icons as shown below.



<sup>1</sup>: Start method switching function: The start method (START items on the [Setup] screen: [Auto-Quick/Auto/Manual] can be switched on the measurement screen by pressing and holding the setup switch.

<sup>2</sup>: Feed Function: It is switched to the feed function by pressing and holding the print switch and the paper is fed.

### c. Joystick

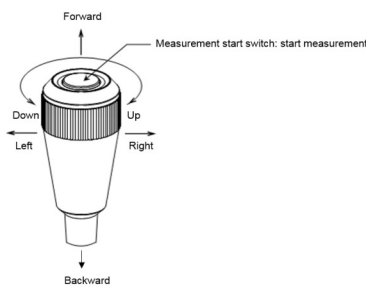
	<ul style="list-style-type: none"> <li>• When moving the joystick forward, the measurement unit moves to the side of the examinee.</li> <li>• When moving the joystick backward, the measurement unit moves to the side of the examiner.</li> <li>• When moving the joystick to the right or the left, the measurement unit moves to the right or the left (respectively).</li> <li>• When rotating the joystick to the right, the measurement unit moves up and when rotating the joystick to the left, the measurement unit moves down.</li> </ul>
---	--

### d. Patient environment

When the patient or practitioner comes into contact with the device parts (including the connecting parts) or when the patient or practitioner is in direct contact with the person that touches these device parts (including the connecting parts), the patient environment is shown below

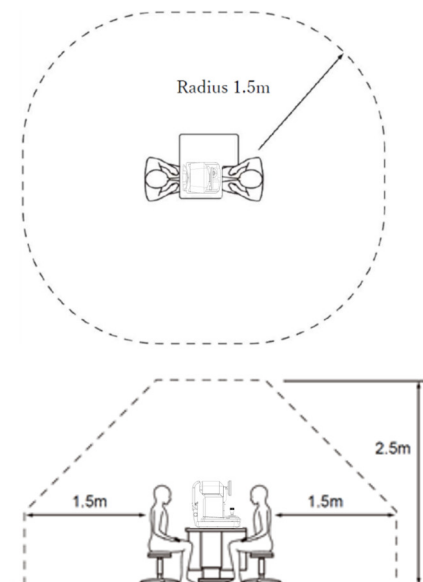

Suitable device to use in the patient environment:

- Personal computer
- Monitor display for PC

Use one that conforms to the safety standards of IEC 60601-1 or IEC 62368-1.



- Don't connect an additional power strip or an extension cord to the system.
- Don't connect any device which is not recognized as one component of the system.



If it can be identified that turning this device on or off causes harmful interference to other devices, take one of the following actions:

- Reorient or relocate the receiver
- Increase the separation between devices
- Connect to a power strip on a different branch circuit

### e. Classification of device

According to Medical Device Regulation (R(EU) 2017/745), the AKR 550 is a class I with measuring function.

Class 1 equipment is equipment in which protection against electric shock does not rely on basic insulation only, but which includes an additional safety precaution in that means are provided for the connection of the equipment to a protective earth conductor in the fixed wiring of the installation in which a way which accessible metal parts cannot become live in the event of a failure of the basic insulation.

Degree of protection against electrical shock: Type B Equipment (IEC 60601-1)

Type B equipment provides an adequate degree of protection against electrical shock, particularly regarding allowable leakage currents and reliability of the protective earth connection.

- Degree of protection against harmful intrusion of water (IEC 60529): IPX0.
- This product does not provide protection against intrusion of water.
- Classification by operation mode: Continuous operation with short-time loading.
- Mode of operation: This product is for continuous operation. It takes approx. 2 sec. for each measurement.







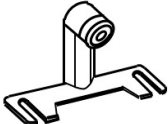
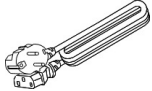

Classification by safety of use in air/ flammable anesthetic gas, oxygen or nitrous oxide/ flammable anesthetic gas atmosphere:

- Equipment not suited for use in air/flammable anesthetic gas, oxygen or nitrous oxide/flammable anesthetic gas atmosphere.
- This product should be used in an environment free of flammable anesthetic gas and other flammable gases.

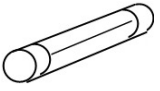
## 2. List of accessories

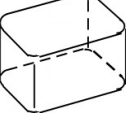
The device has no accessories. However, the following items are supplied with the device:

Model Eye: (x1)	With a contact lens holder. Diopter value is indicated on the sticker	
Power cord: (x1)	Name model: KP4819YKS31A or equivalent Length: 2.5m	
Printer paper: (x3)	Width: 58mm 2 included and 1 installed in the unit	
Fuse: (x2)	T2A L 250V	
Chinrest liner: (x1)	1,000 sheets	
Chinrest liner pin: (x2)	/	
Dust cover: (x1)	/	
Operation manual: (x1)	/	



Use only the items specified by us.

Use of the compatible items (power cord) other than specified above may adversely affect other instruments and/or cause malfunction of this device.



Extra care should be taken for storage of a model eye.

Do not store it at where it is dusty or out of the specified ranges regarding environmental conditions.

Avoid direct sunlight, high-temperature and humidity when storing the printer paper because it is a thermal paper.

# V. OPERATING INFORMATION

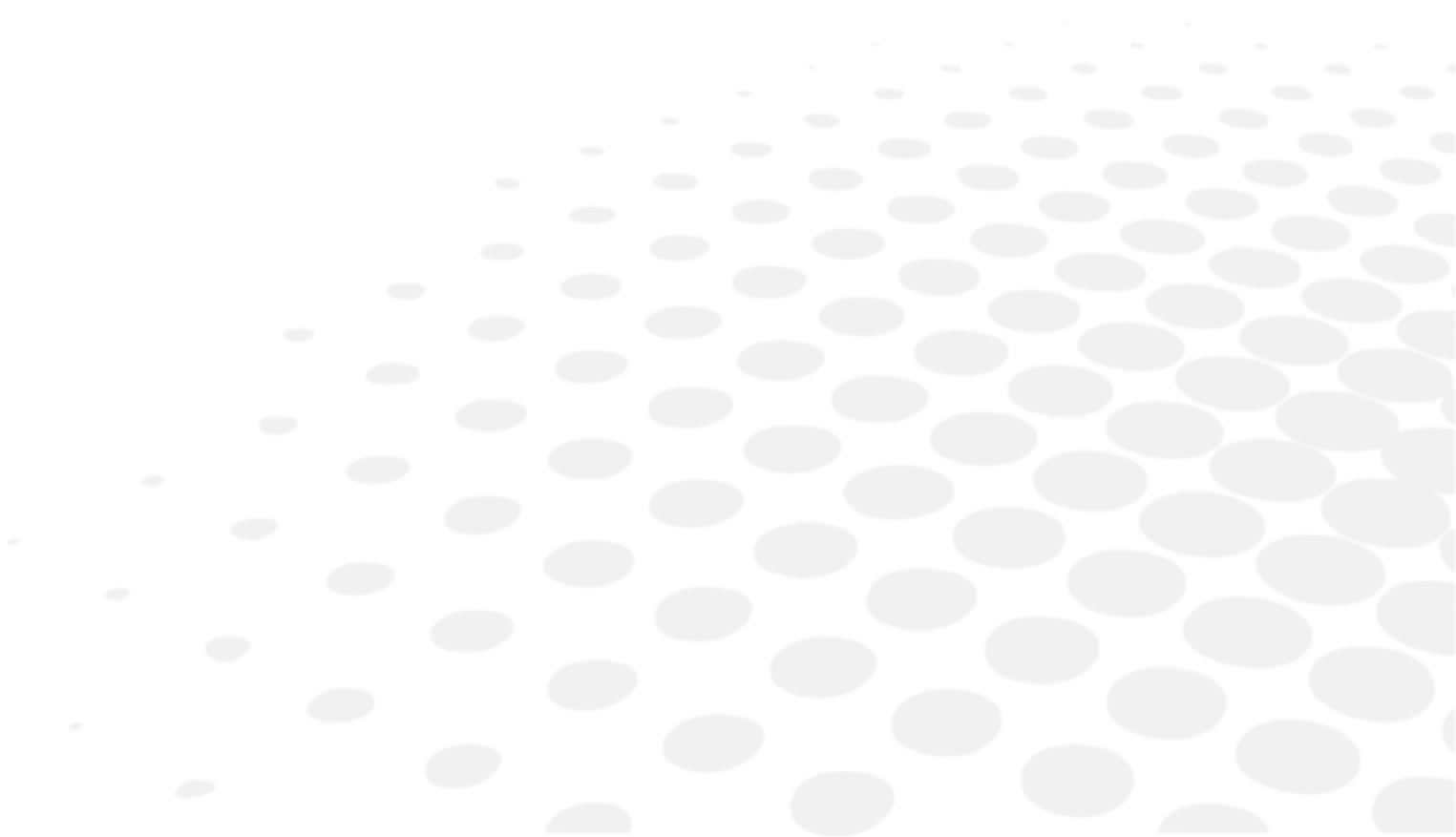

## 1. Installation of the device



Once installed and placed into service, this device is not intended to be moved from one installation place to another.



- Do not operate it at the place where it is either dusty or grubby.
- Environment with extremes in heat and humidity should also be avoided. In case of using the device, fulfill the environmental conditions at the time of unpacking and use.



- Do not expose the view window of the device directly to the sunlight or bright lighting from other sources.
- Great care should be taken because the measurement cannot be carried out if the examinee is exposed to strong light or glare during the measurement and his/her pupil contracts too small.
- Keep away from the sites which may experience strong vibrations or sudden shocks.
- It can result in malfunction if the device is accidentally overturns. Also, it is very dangerous if it is dropped on your foot etc. Do not store it at the unstable or high place.

- Do not expose the view window of the device directly to the sunlight or bright lighting from other sources.
- Do not operate it at the place where it is either dusty or grubby.
- Environment with extremes in heat and humidity should also be avoided. In case of using the device, fulfill the environmental conditions at the time of unpacking and use.
- Keep away from the sites which may experience strong vibrations or sudden shocks.
- It can result in malfunction if the device is accidentally overturns. Also, it is very dangerous if it is dropped on your foot etc. Do not store it at the unstable or high place.

### a. Unpacking method of internal packing box

- 1 Cut the fixing bands and pull up the internal packing box.
- 2 Remove the cardboard on the top and included items, then remove the packing material.
- 3 Hold A and B on the base and take out the device.
- 4 Do not hold the head unit, the headrest, the joystick or the LCD unit.
- 5 Remove the buffers after taking it out.

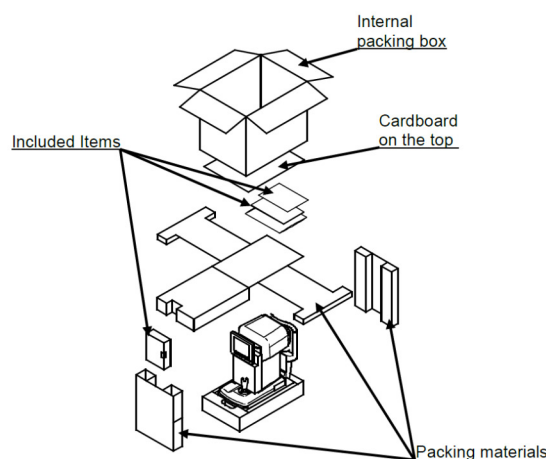

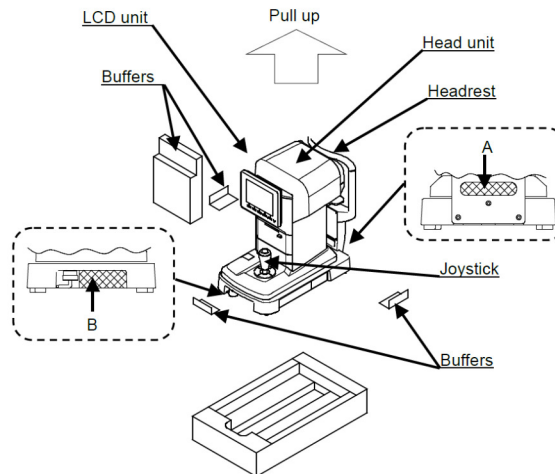

## b. Connection / Wiring

Connect the earth cable of the power cord to the earth terminal.



To avoid the risk of electric shock, this equipment must only be connected to a supply means with protective earth.



- Do not damage the power cord (folding it small, pulling it or putting a heavy object on it etc.). Also, do not remodel it.  
Especially at the time of installation, keep enough space for the power cord to prevent it from being damaged or failure.
- If the cord is damaged (disconnection, failure of coating etc.), replace it with the new one.  
It can result in electrical shock or fire.
- Insert the power cord in the outlet and this device securely.  
If it is not connected securely, it can result in fire or electrical shock.
- Clean the power cord all the time to avoid dust or oil etc.  
It can result in malfunction or fire if the terminal unit is not clean.
- Check if the terminal unit is dirty when the power cord becomes hot.  
If it is not dirty, replace it with the new one. It can result in fire or malfunction if you keep using it.



- Use this device with the proper power-supply voltage.  
If the power-supply voltage is excess, it can result in malfunction or fire.
- Hold the plug unit when plugging in and out.
- Do not touch the power plug with wet hands. It can result in electrical shock.



Plug out the power cord when it is not used for a long time.

## **VI. USE OF THE DEVICE**



## 1. Measurement flow

1. Prepare for measurement
2. Power distribution
3. Ask an examinee to ready for a measurement
  - Setting of [Setup] screen
  - Fuse replacement
  - Setting of chinrest liner
  - Alignment
4. Tip for effective measurement
5. Take a measurement
  - Error display
6. Print out the measurement result
  - Reload of printer paper
7. Switch right/left eye of the examinee OR switch the examinee
8. Storage of the device

This device has the auto/manual measurement switch function. In case of the auto measurement, the measurement is started automatically after alignment is achieved. In case of the manual measurement, on the other hand, the measurement is started by pressing the measurement start switch.



The measurement can be started manually by pressing the measurement start switch even when the setting of Start is either [Auto] or [Auto-Quick].

## 2. Preparation

### a. Preparation for measurement

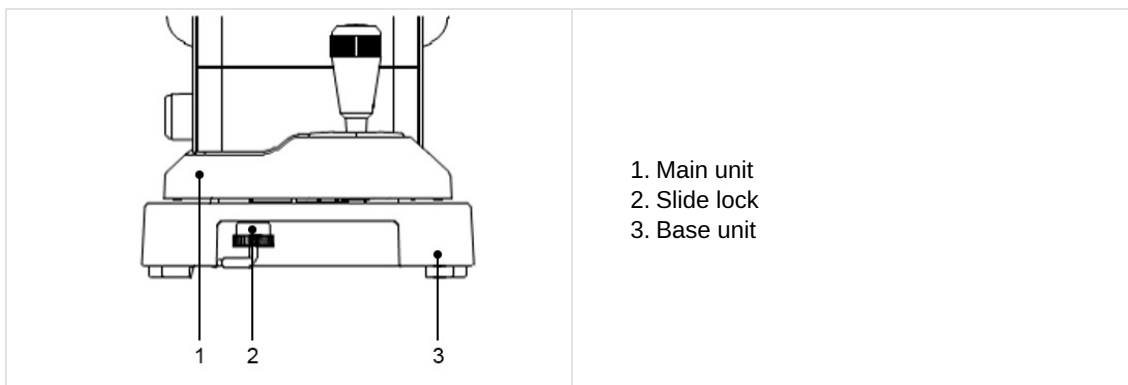

- Do not place the device at where outside light exposes it directly from the examinee side.
- Make sure that the printer paper, the fuse and the chinrest liner are installed properly.
- Refer to the chapter below for the installation procedures of the parts of (2) above:
  - Reload of Printer Paper
  - Fuse Replacement
  - Setting of Chinrest Liner
  - Storage and Maintenance
- After distributing the power, rotate the slide lock of the main unit (under the base unit) and release the main unit.

## b. Power distribution

- 1 Make sure that the power switch of the main unit is OFF (O).

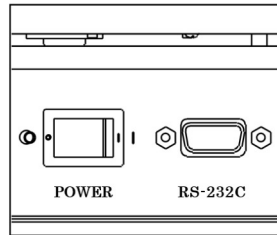

- 2 Insert the power cord in the power plug connector of the main unit and insert the power plug in a socket.

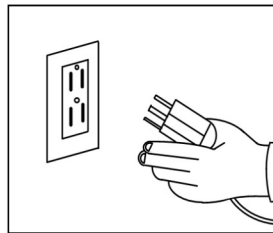

- 3 Turn on the power switch (I) of the main unit.











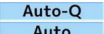

- Always make sure that the cable is grounded.
- Do not use an additional power strip or an extension cord.

## c. Standby

When the power is turned on, the screen as shown below appears on the LCD monitor, which is ready for the measurement.

1. Indication of right eye
2. Measurement start method
3. Mark of measurable minimum pupil diameter
4. Indication of left eye **Left** is indicated when measuring the left eye
5. Reticle mark
6. Vertex distance
7. Pupil distance

Icon	Function
 	Indicate the eye (right or left) in process of measurement.
 	Indicate the measurement start method.
	Indicate the vertex distance. It can be switched between 0, 10, 12, 13.5 and 15mm.
	Clear the measurement results (values).
	Switch ON and OFF of the IOL mode.
	It switches the measurement mode. There are 4 measurement modes: refractive and keratometry continuous measurement, refractive measurement, keratometry measurement and scotopic pupil size measurement.
	It is switched to the [Setup] screen.
	Display and print out the measurement result.

#### d. Preparation of examinee

- 1 Clean the chinrest and dispose one chinrest liner on the top.



Clean the chinrest with the neutral cleanser when there is no chinrest liner.

For cleaning the chinrest, use the ethanol.

- o Ethanol for disinfection contains 76.9 to 81.4vol% of ethanol (C<sub>2</sub>H<sub>6</sub>O) at 15°C (specific gravity).

- 2 Instruct the patient to take off spectacles or contact lenses and sit.

- 3 Ask the examinee to put his/her chin on the chinrest. Adjust the height of the chinrest so that the examinee's eye level is in line with the eye mark. Any exams performed with contact lens can lead to wrong results.



Uncomfortable posture may fatigue the examinee during the measurement. Adjust the chinrest or the device to avoid it.

It affects its measurement accuracy if the examinee moves his/her head during the measurement. Ask him/her to fix his/her forehead on the headrest and look at the target with a good posture.

- 4 Talk to the examinee fluently and try not to make him/her nervous.

### 3. Alignment

There are 3 types of startup procedures [Auto Quick, Auto and Manual] for AKR 550.  
It can be switched in start of the [Setup] screen.

#### a. In case of [Auto Quick] or [Auto]

 It starts measurement automatically when it brings the subject eye into focus.

- 1 Look for the subject eye by operating the joystick.
  - > The Kerato ring appears as bringing it into focus.

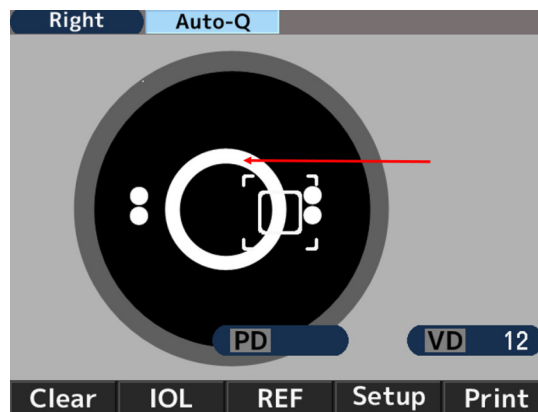

 If the eyelid is over the Kerato ring, urge the examinee to open his/her eye wider.  
The device cannot be used for patients for which the pupil cannot be centered.

- 2 The alignment mark (+) will appear as aligning the reticle mark with the center of the pupil of the subject eye and bringing it into focus. Operate the joystick in such a way that the alignment mark (+) comes to the center of the reticle.

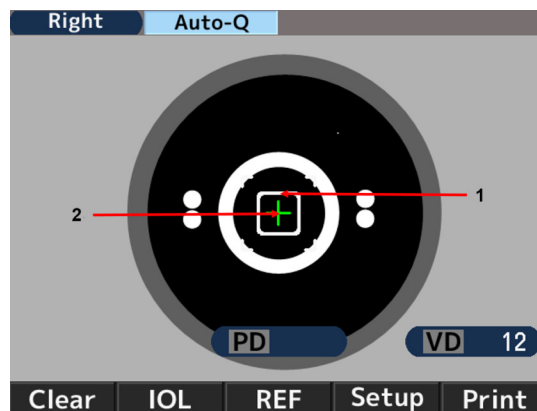

1. Reticle mark
2. Alignment mark

- 3 Operate the joystick so as to bring it into focus as aligning the alignment mark (+) with the center of the reticle mark. The measurement is started when alignment is achieved and the mark of the measurable minimum pupil diameter is changed to green.

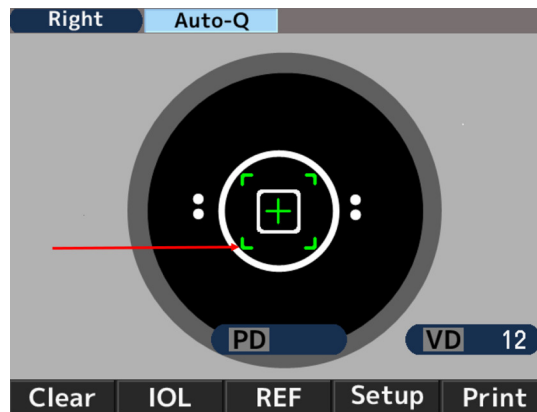

- 4 If the alignment is shifted to the side after starting measurement, [Re-alignment] is displayed and measurement is stopped. If measurement is stopped, please perform alignment again.

When the alignment mark and focus indicator light up green, the measurement is resumed.

After [Re-alignment] is displayed, measurement will be started even if the alignment mark is not displayed or the focus indicator does not light up green after 2 seconds have passed.



- 5 The measurement values are displayed when the measurement is finished. The arrows are displayed when the specific times of measurement is finished. Move the main unit to the direction of the arrows and take a measurement of the other eye.

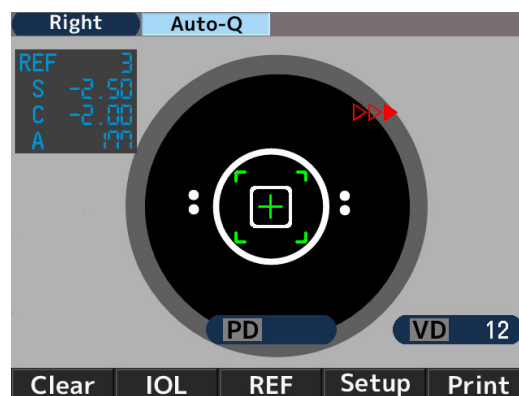

**b. In case of [Manual]**

- 1 Look for the subject eye by operating the joystick.
  - > The Kerato ring appears as bringing it into focus.

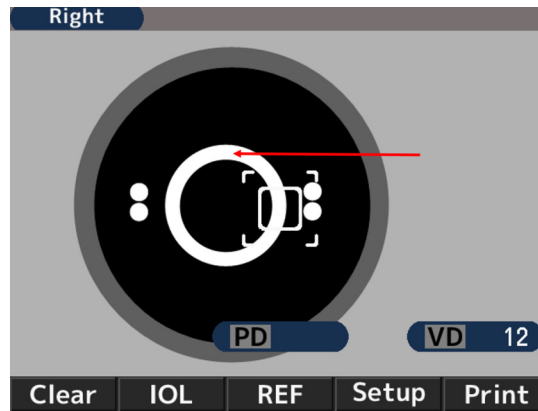

If the eyelid is over the Kerato ring, urge the examinee to open his/her eye wider.

- 2 The alignment mark (+) will appear as aligning the reticle mark with the center of the pupil of the subject eye and bringing it into focus. Operate the joystick in such a way that the alignment mark (+) comes to the center of the reticle.

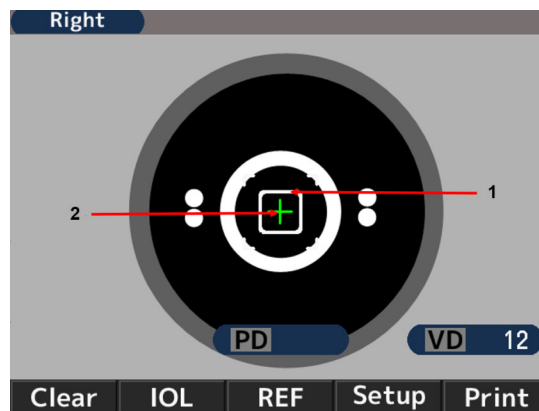

1. Reticle mark
2. Alignment mark

- 3 Operate the joystick so as to bring it into focus as aligning the alignment mark (+) with the center of the reticle mark. Start the measurement when alignment is achieved and the mark of the measurable minimum pupil diameter is changed to green.

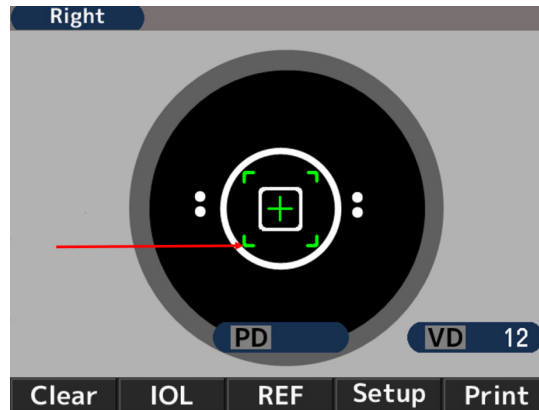

#### 4. Tips for effective measurement



- Do not allow external light to directly penetrate the room.
- Fluctuation of the measurement values may occur if the examinee looks something other than the target. Urge the examinee to concentrate on the target set in front.
- Talk to the examinee in a relaxed and friendly manner, so as to allay any fear or doubt they may have.
- Inappropriate height of the chinrest or the chair will cause the examinee fatigue. Adjust the (optional) instrumental table to establish the most comfortable and convenient position for the examinee.
- When the eyelash or eyelid interfere measurement, an error will occur in the measurement. Urge the examinee to keep his/her eye open wider.
- Tear residue or eye mucus, etc. trapped on the corneal surface may cause measurement errors. Check the surface with the LCD monitor, and if you see something moving when the examinee blinks, remove it before measurement.
- When the pupil of the target eye is smaller than the minimum measurable pupil diameter, the device cannot take measurements correctly.
- If it is difficult to take measurements because the pupil is too small, darken the surroundings (room) or the target to allow the pupil to dilate as much as possible.
- If the examinee moves his/her head during the measurement, AXIS value will be adversely affected.
- Ask him/her to maintain a correct posture.

#### 5. Measurement

The measurement start method is different depending on the setting.

Setting	Measurement start method
The setting of start is either [Auto-Quick] or [Auto]	The measurement is started automatically when alignment is achieved.
The setting of start is [Manual]	Start the measurement by pressing the start switch when alignment is achieved.



1. Number of refractive measurement
2. Refractive measurement value
  - S: Spherical value
  - C: Cylindrical value
  - A: Axis angle
3. Number of Kerato measurement
4. Kerato measurement value
  - R1: Radius of curvature (Max.)
  - R2: Radius of curvature (Min.)
  - AX: Axis Angle
5. Photopic pupil diameter measurement result
6. Vertex distance
7. Pupillary distance
  - Far vision
8. Pupillary distance
  - Near vision



The PD value is indicated after the refractive power of both right and left eyes are measured.  
 The order of the eye to be measured is not important.  
 The NPD value is indicated only if the number of [W-D (cm)] on the [Setup] screen is set.

## 6. Print-out of measurement result

The measurement result can be printed out by pressing the print switch after the measurements.

A maximum of the data for each eye can be saved and the most reliable value among them is indicated as the optimum value. The optimum value is printed out only when more than three times of measurement is taken for each eye. The format of the output [All, All/Eco, Eco or OFF] can be set on [Print REF/KRT] on the [Setup] screen.

- **[All]**: Print out a maximum of ten data of the refractive measurement and Kerato measurement for each eye.
- **[All/Eco]**:
  - Print out a maximum of ten data of the refractive measurement for each eye.
  - Print out only the optimum values for the Kerato measurement.
- **[Eco]**: Print out only the optimum values for all of the measurement.
- **[Off]**: Print out no data.

### Sample of Printout 1

Print [REF/KRT] setting : Eco

NAME		2011 11 22		14:30
D=12				
R>	SPH	CYL	AX	
	- 3.87	-0.75	172	
R>	mm	D	AX	
R1	8.33	40.50	175	
R2	8.20	41.12	85	
AVE	8.26	40.75		
CYL		-0.62	175	
<L>	SPH	CYL	AX	
	- 3.75	-1.12	14	
<L>	mm	D	AX	
R1	8.37	40.37	8	
R2	8.12	41.50	98	
AVE	8.25	40.87		
CYL		-1.13	8	
PD =	70			
AKR550				

**1. Date and time of the measurement**

**2. Refractive measurement result (optimum value)**

- o SPH: Spherical value
- o CYL: Cylindrical value
- o AX: Axis angle

**3. Kerato measurement result (optimum value)**

- o R1 : Radius of curvature (Max.)
- o R2: Radius of curvature (Min.)
- o AVE: Average of R1 and R2
- o CYL: Cylindrical value

**4. Pupillary distance\***

\* The value displayed is informative.

The practitioner is recommended to get more accurate information by using a device intended by its manufacturer to directly measure these parameters.

**Sample of Printout 2**

Print [REF/KRT] setting: All

<b>1</b> ABCDEFGHIJKLMNOPQRSTUVWXYZ abcdefghijklmnopqrstuvwxyz			
<b>2</b> No. 00001			
<b>3</b> NAME		2011 11 22 14:30	
<b>4</b> D=12			
<b>4</b> <R>	SPH	CYL	AX PPS
	- 3.75	-0.75	172 6.6
	- 3.87	-0.75	170 6.5
	- 3.87	-0.62	174 6.6
<b>5</b>			
<b>6</b>			
<b>7</b>	- 3.87	-0.75	72 6.6
<b>7</b> SE	- 3.98	SPS	7.9
<b>8</b>			
<b>9</b> <R>	mm	D	AX
R1	8.43	40.00	9
R2	8.21	41.12	99
AVE	8.32	40.62	
CYL		-1.12	9
R1	8.43	40.00	10
R2	8.22	41.12	100
AVE	8.32	40.50	
CYL		-1.12	100
R1	8.30	40.62	2
R2	8.16	41.37	92
AVE	8.23	41.00	
CYL		-0.75	2
<b>10</b>			
R1	8.31	40.62	180
R2	8.17	41.37	90
AVE	8.24	41.00	
CYL		-0.75	180
<b>11</b>			
REST		-0.12	90
<L>	SPH	CYL	AX PPS
	- 3.75	-1.12	13 6.6
	- 3.75	-1.12	15 6.6
	- 3.75	-1.12	14 6.6
	- 3.75	-1.12	14 6.6
SE	- 3.99	SPS	7.9
<b>12</b>			
<b>13</b>			
IPD	= 65	INPD	= 62 (50)
AKR550			

1. Message area
2. No. of examinee
3. Data of right eye
4. Refractive data
5. Photopic pupil size\*
6. Optimum values of the refractive measurement results  
They are indicated when more than 3 times of measurements are taken for each eye
7. Spherical equivalent
8. Scotopic pupil size\*
9. Kerato data
10. Optimum values of the corneal curvature radius  
They are indicated when more than 3 times of measurements are taken for each eye
11. Residual astigmatism
12. PD for far vision\*
13. PD for near vision\*

\*The value displayed is informative.

The practitioner is recommended to get more accurate information by using a device intended by its manufacturer to directly measure these parameters.

## Message area

It can print out the registered characters in the range of 24 characters/line × 2 lines in the message area. Refer to the [Message] section of Setting of [Setup] screen” about registration of the characters.

## 7. Handling after measurement

- 1 Turn off the power switch and unplug the power supply cord after measurement.



If RS-232C is connected, disconnect the connection cable as well.

- 2 Lower the main unit undermost, set it in the center of the base unit and fix the main unit to the base by tightening the slide lock on the main unit.
- 3 Put the dust cover and store it in a safe place.



Refer to "Storage of Device" about the details.

## 8. Setting of [Setup] screen

The standard measurement mode is preset to be ready for use.

However, altering the setting can be done easily if necessary.

Press [SETUP] switch under the LCD monitor and display the [Setup] screen.

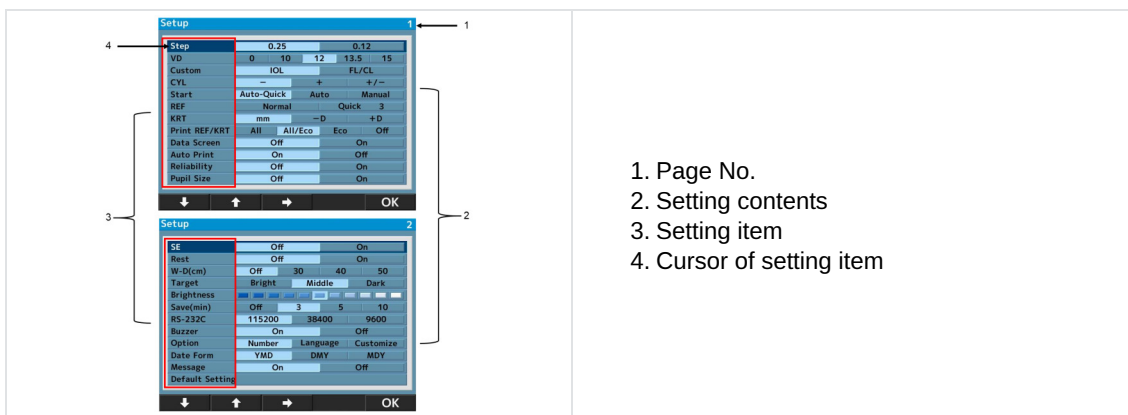

There are 24 setting items on the menu screen.

Select the item to be changed by pressing  or  and change it by pressing .

After changing it, return to the measurement screen by pressing [OK].

### Details of each setting item - [Screen 1]

- **[Step]:** Select the step for refractive measurement.
- **[VD]:** Select the corneal vertex distance.
- **[IOL]:** Select the function of the operation switch.
  - [IOL]: Switch to the mode to measure.
  - [IOL. FL/CL]: Switch the corneal vertex distance (frame value/ contact value).
- **[CYL]:** Select the sign of cylindrical value.
- **[Start]:**

Select the measurement start method.

  - [Auto-Quick]: It starts measurement when the alignment is achieved. Take 1 time of Kerato measurement and 3 times of refractive measurements continuously for each eye.  
The result is printed out automatically when [Auto Print] is set as [ON]. (For the refractive measurement, only one time of the fog control is done at the beginning).
  - [Auto]: Take 3 times of Kerato measurements and refractive measurements continuously for each eye.

The result is printed out automatically when [Auto Print] is set as [ON]. (For the refractive measurement, the fog control is done every time).

- [Manual]: Measurements are taken every time the measurement switch is pressed.
- **[REF]:** Select the refractive measurement method. The setting is valid only when the measurement start method is set as manual.
  - [Norma]: A measurement is taken one time by pressing the measurement start switch.
  - [Quick]: Continuous measurement is started as much as it is set by pressing the measurement start switch one time. (Maximum of 10 times.) (For the refractive measurement, only one time of the fog control is done at the beginning).
- **[KRT]:** Select the sign of Kerato measurement result.
  - [mm]: Corneal Curvature radius
  - [- D]: corneal astigmatism (-)
  - [+D]: corneal astigmatism (+)
- **[Print REF/KRT]:** Select the format of print-out.
  - [All]: Print out all of the measurement data.  
(Maximum of 10 times for each eye).
  - [All/Eco]: Print out all of the REF measurement.  
(Maximum of 10 times for each eye).  
Print out only the optimum values for the Kerato measurement.
  - [Eco]: Print out only the optimum values.
  - [Off]: No measurement result is printed out.
- **[Data Screen]:** Display the stored measurement results.
  - [On]: Display the measurement results on the screen.
  - [Off]: Display no measurement result on the screen.
- **[Auto Print]:** Select the print-out method.  
This function is valid only when the setting of Start is either Auto-Quick or Auto.
  - [On]: Activate the auto print function.
  - [Off]: Invalidate the auto print function.
- **[Reliability]:** Select if displaying the low reliability mark on the measurement values or not.
  - [On]: If it is judged that the measurement value possesses low reliability, display the low reliability mark [\*] on it.
  - [Off]: No low reliability mark is displayed.
- **[Pupil Size]:** Set the function of the photopic pupil diameter measurement.
  - [On]: Take a measurement of the photopic pupil diameter when taking a refractive measurement.
  - [Off]: Photopic pupil diameter is not measured.

#### Details of each setting item - [Screen 2]

- **[SE]:** Set the output of SE value.
  - [On]: Output the representative value of SE on print-out, data screen and communication output (XML format only).
  - [Off]: No output of SE value.
- **[Rest]:** Select the output of residual astigmatism.
  - [On]: Display the residual astigmatism.
  - [Off]: No astigmatism is displayed.
- **[W-D (cm)]:** Set the work distance.  
The near pupil distance is automatically computed after the measurement and displayed on the screen.
- **[Target]:** Select the brightness of the target.

- [Bright]: Brighten the target.
- [Middle]: Normal setting.
- [Dark]: Darken the target.
- **[Brightness]**: Adjust/ change the brightness of the LCD monitor.
- **[Save (min)]**: Select the switchover time to activate the power saving function (unit is min.).
- **[RS-232C]**: Select the baud rate when sending the measurement data to the exterior computer.
- **[Buzzer]**: Set if activating the buzzer at the time of switching to the power saving function or not.
  - [On]: Buzzer is ON.
  - [Off]: Buzzer is OFF.
- **[Option]**: It is switched to each option screen when selecting the item to be set on the option of the [Setup] screen.

The screen of each option and the details.

#### a. [Number]

This function can set or change the number of the examinee, and select if displaying the number on the monitor and the printout.

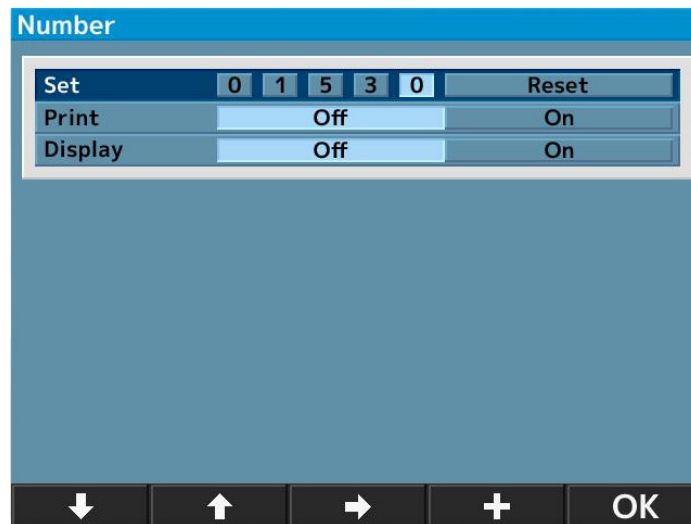

- **[Set]**: Set/change the number of the examinee.  
(Maximum of 5 digits can be input).
- **[Print]**: Select if printing out the number of the examinee or not.
  - [Off]: The number is not printed out.
  - [On]: The number is printed out.
- **[Display]**: Select if displaying the number of the examinee on the screen or not.
  - [Off]: The number is not displayed.
  - [On]: The number is displayed.



#### Reset of the number of the examinee

If moving the cursor to [Reset] on [Set], the [+] switch on the bottom is changed to [Reset]. So, press the [Reset] switch to reset the number.

- 1 Move the cursor to the item to be set or changed by pressing or and change it by pressing or [+].
- 2 Go back to the [Setup] screen by pressing [OK] after the setting or the change.

## b. [Language]

This function can select the language displayed on the screen.

Selectable language: EN (English), CN (Chinese), FR (French), ES (Spanish), PT (Portuguese), IT (Italian), GE (German).

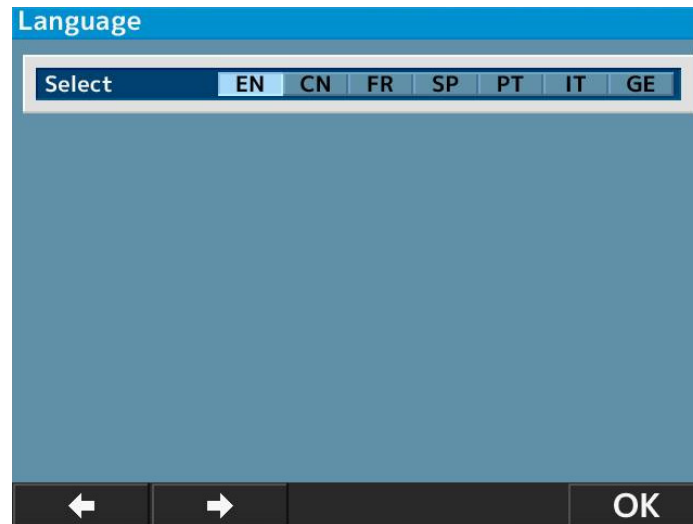

- 1 Move the cursor to the item to be set by pressing  and execute it by pressing [OK]..
- 2 Go back to the [Setup] screen by pressing [OK] after finishing the setting.

## c. [Customize]

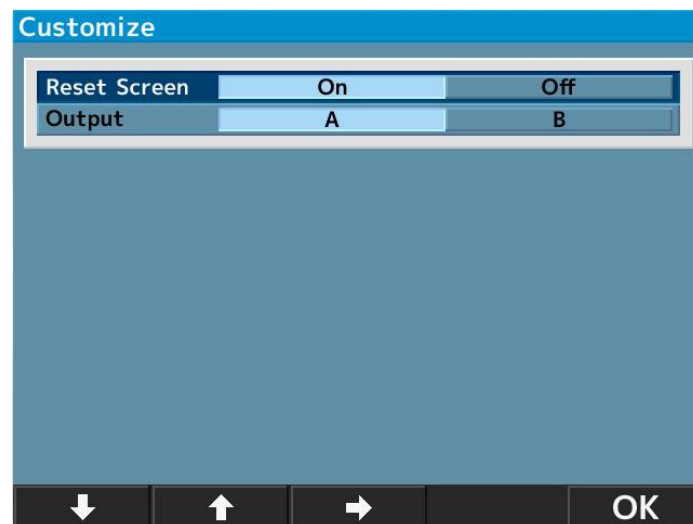

- **[Reset Screen]:** This function can delete the measurement values on the screen after printout.
  - [On]: Delete the measurement values on the screen after printout.
  - [Off]: Leave the measurement values on the screen after printout.
- **[Output]:** This function can select the output procedure of the measurement data.
  - [A]: Standard.
  - [B]: Output data common spec. of ophthalmic testing device.

(Established by Japan Ophthalmic Instruments Association)



#### d. [Date form]

Select the display format of the date from the followings:

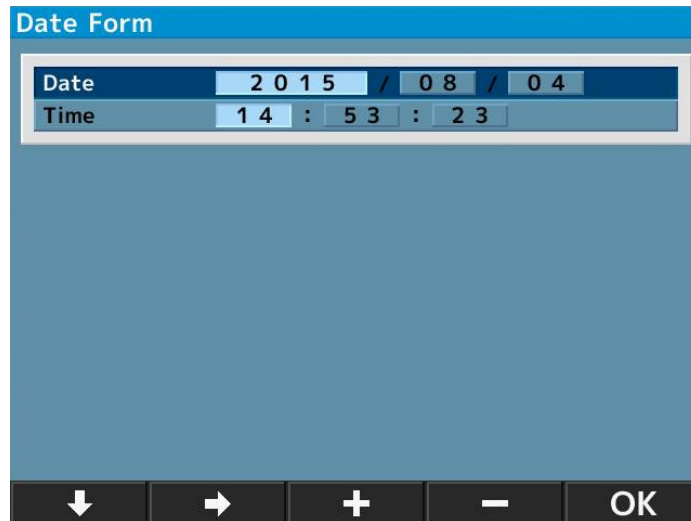
- [YMD]: Display the date as year/ month/day.
- [DMY]: Display the date as day/month/year.
- [MDY]: Display the date as month/day/year.



The screen above appears when selecting [YMD] and pressing [Enter].

- 1 Move the cursor to the item to be changed by pressing  or  and input the date by pressing [+] or [-].
- 2 Go back to the [Setup] screen by pressing [OK] after finishing the setting.

#### e. [Message]

This function is to input the message in the range of 24 characters/line × 2 lines and output it.

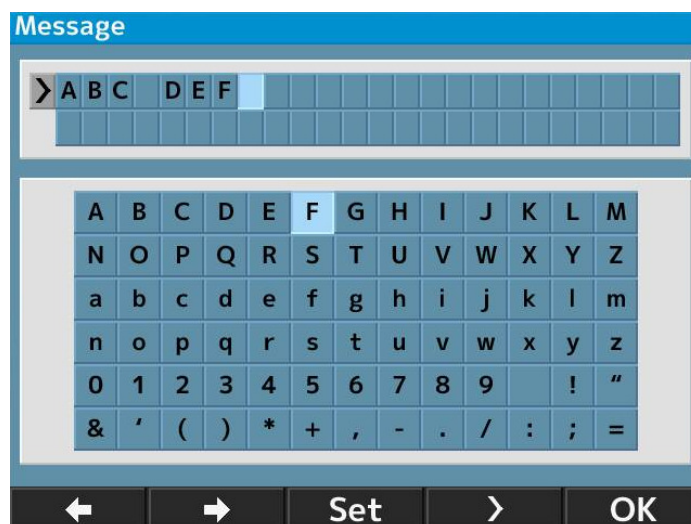

The message input screen appears by selecting [On] and pressing [Enter].

- 1 Select the characters by pressing  or  and input them by pressing [Set].



A space can be input by pressing .

- 2 Go back to the [Setup] screen by pressing [OK] after finishing the setting.

#### f. [Default setting]

Reset the settings to the factory setting.

### 9. Scotopic Pupil Size (SPS) - Measurement function

This function is to estimate the pupil size of the subject eye in the dark.

Switch to the SPS measurement by pressing the measurement mode switch on the front panel.

When estimating\* the scotopic pupil size, darken the room.

\*The value displayed is informative.

The practitioner is recommended to get more accurate information by using a device intended by its manufacturer to directly measure these parameters.

#### Indication of SPS measurement mode



#### To print out the measurement results of SPS, R/K, REF and KRT at the same time

The measurement results of SPS, R/K, REF and KRT can be printed out at the same time by pressing the print button after the measurement of SPS when switching to SPS measurement mode without printing out their measurement result with the setting of [Auto Print OFF].

Example of printout	Example of data screen output
<pre> NAME 2011 11 22      14:30  VD=12 &lt;R&gt; SPS  7.3  &lt;L&gt; SPS  7.5  PD =  63  AKR550         </pre>	

## 10. IOL measurement function



When measuring the IOL (intraocular lens) implanted eye, the eye with a cataract, or the eye with the scratches on the cornea, the measurement errors may occur and it is difficult to complete the measurement with REF measurement.

In this case, it is easier to measure if moving the device closer to the examinee. Also these can be measured with IOL mode.

- 1 Activate the IOL function by pressing the IOL switch on the front panel of the main unit and switch to the IOL measurement mode.

At this time, the icon of the IOL measurement mode is indicated on the top of the monitor.

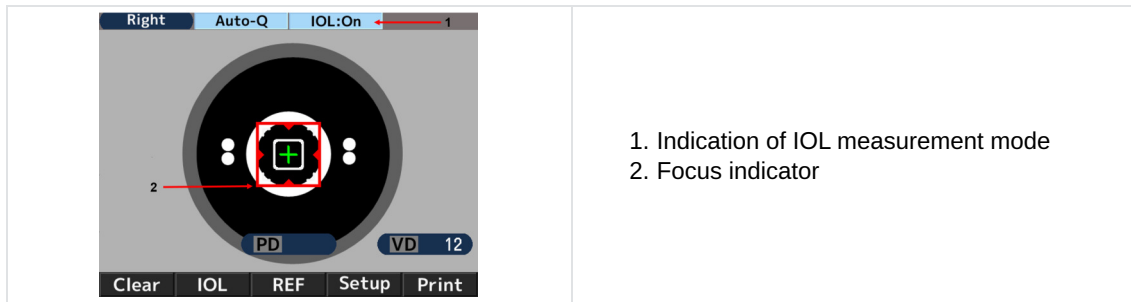

1. Indication of IOL measurement mode
2. Focus indicator

- 2 Catch the subject eye on the monitor by operating the joystick. As bringing the subject eye into focus, the Kerato ring, the alignment mark [+], and the focus indicator appear.
- 3 Operate the joystick by following the guidance of the focus indicator and move the main unit to bring the subject eye into focus.
- 4 It is in focus when the focus indicator turns to green. When it turns to green, take a measurement by pressing the measurement switch.



Measurement is started automatically when the setting of [Start] is either [Auto-Quick] or [Auto].

Example of printout	Example of data screen output
<pre> NAME 2011 11 22      14:30  VD=12  &lt;R&gt; SPH  CYL  AX  PPS I -2.50 -2.00 177 5.4 I -2.50 -2.00 175 5.4 I -2.50 -2.00 177 5.4 ----- -2.50 -2.00 177 5.4                     </pre>	<pre> R)  SPH  CYL  AX  PPS I -2.50 -2.00 177 5.4 I -2.50 -2.00 175 5.4 I -2.50 -2.00 177 5.4 ----- -2.50 -2.00 177 5.4                     </pre>



[I] is indicated on the left of the measurement value when measuring it in the IOL measurement mode.

The IOL measurement mode is canceled by performing one of the followings:

1. Pressing the IOL switch one more time
2. Switching the measurement mode
3. Pressing the print switch
4. Turning off the power



When the measurement cannot be completed because of the errors with IOL mode.

There is a possibility that the measurement of the IOL (intraocular lens) implanted eye cannot be completed because of the implanted IOL.

In this case, move the device closer to the examinee with keeping the alignment in-focus. It might help curbing the influence and the measurement can be done.



The image of the eyeground is displayed by holding IOL or FL/CL switch for seconds.

## 11. Low reliability mark display function

This device has the low reliability mark display function. The low reliability mark is displayed on the measurement result which reliability is low when taking the refractive measurement with this function activated. Consider the refractive measurement value with the low reliability mark as reference.

Example of printout	Example of data screen output
<pre> NAME 2011 11 22      14:30  VD=12 &lt;R&gt; SPH  CYL  AX  PPS * - 2.50 -2.00 177 5.4 * - 2.50 -2.00 175 5.4 * - 2.50 -2.00 177 5.4 ----- - 2.50 -2.00 177 5.4                     </pre>	<pre> R)  SPH  CYL  AX  PPS  RIGHT * - 2.50 -2.00 177 5.4 * - 2.50 -2.00 175 5.4 * - 2.50 -2.00 177 5.4 ----- - 2.50 -2.00 177 5.4                     </pre>

## 12. Output

This device is connected to PC etc. by RS232C.

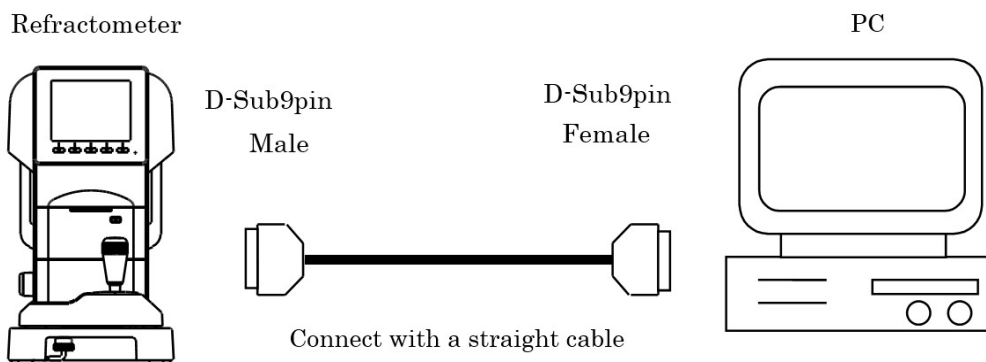

**Connecting diagram: RS232C**

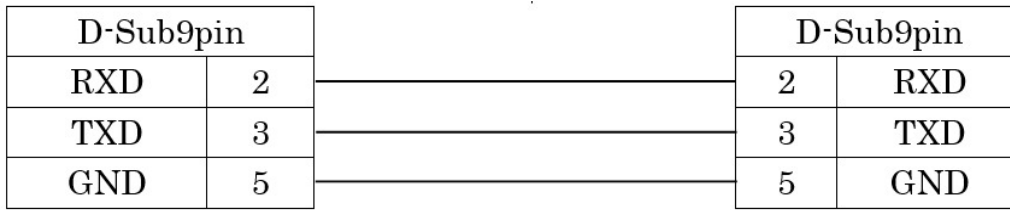

Use the shielded wire for the connection cable to protect the output data from noise.



Contact your local distributor about operation, connection method and output data etc.



The instruments which are connected to this device by RS232C should comply with the safety standard of IEC60601-1.



Do not touch the external connection terminal and examinee at the same time. It may cause electric shock.

Select the baud rate of RS232C from below.

Selectable baud rate	Setting before shipment
115200 bps	Applicable value
38400 bps	Not applicable
9600 bps	Not applicable



In case of RS232C, [Character] (data bit count), [Parity] (check of transfer data) and [Stop bit] (exit code) are set as [Character] (8), [Parity] (none) and [Stop bit] (1) and cannot be changed.

**13. Data screen function**

The measurement results can be displayed on the screen and checked by using the data screen function.

**In case of displaying measurement results**

- 1 Set [Data Screen] on the [Setup] screen as [On].

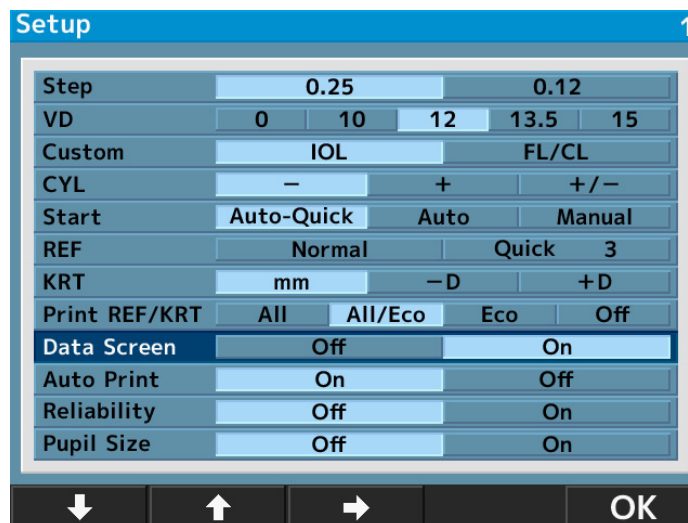



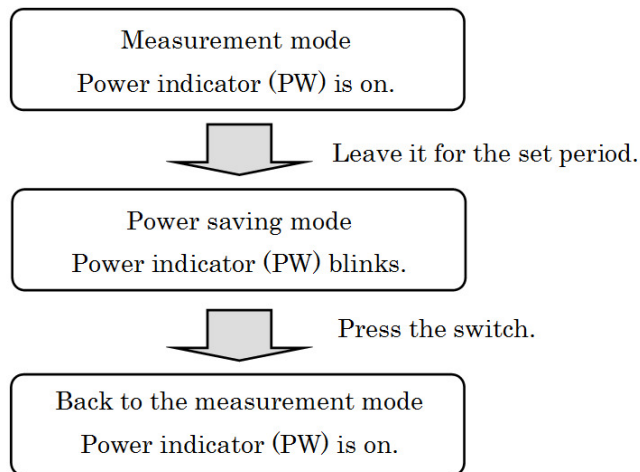

## 15. Contact lens: measurement of base curve

This device can measure the base curve of the hard contact lens.

The lens can be measured by placing it onto the contact lens holder of the model eye shown as below.

- 1 Put a small amount of water on the concave side of the contact lens holder.
- 2 Place the contact lens so that its convex side faces the holder.

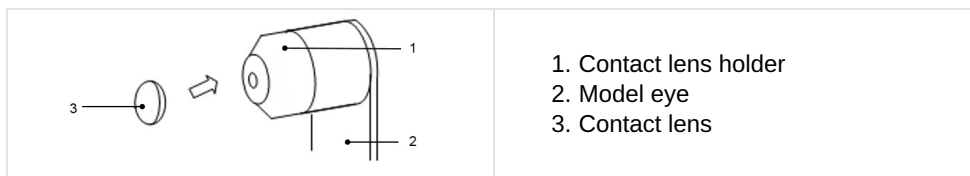

1. Contact lens holder
2. Model eye
3. Contact lens

- 3 Confirm that the contact lens is firmly adhered to the holder with water and does not slip down. Then, take a measurement by setting the model eye unit on the main unit.

## VII. MAINTENANCE

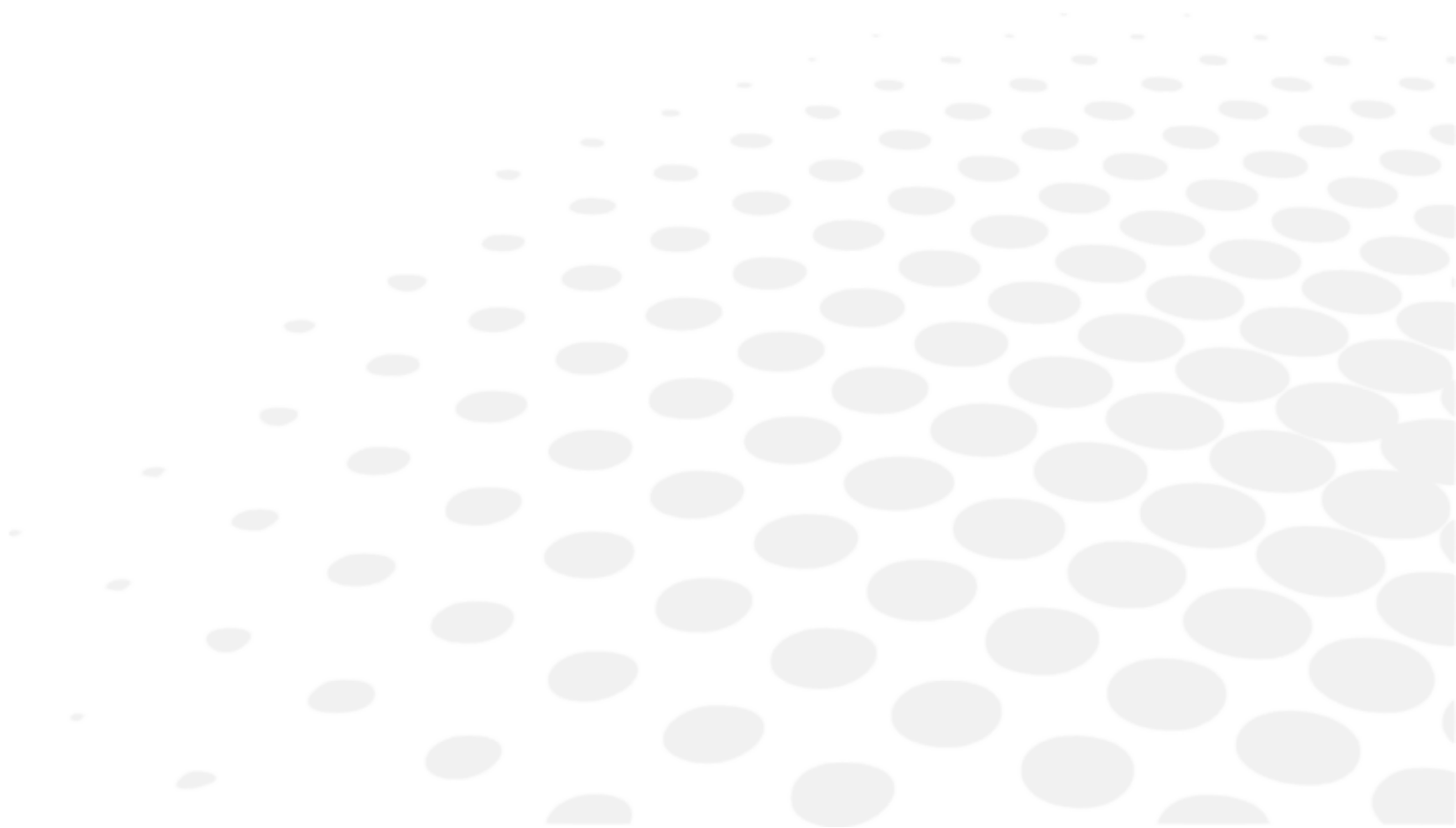



The circuit diagram, parts lists, and description and instructions for calibration and testing are available separated from this manual.



Do not perform any maintenance when used with a patient.

## 1. Storage and handling condition



Respect the operating, storage and transport conditions noted below.

	Temperature	Humidity	Atmospheric pressure
Use	[10°C ; 40°C]	[30% ; 90%]	[800hPa ; 1060hPa]
Storage	[-10°C ; 55°C]	[10% ; 95%]	[700hPa ; 1060hPa]
Transportation	[-40°C ; 70°C]	[10% ; 95%]	[500hPa ; 1060hPa]



The original packaging of this device complies with section 5 EN ISO 15004-1:2020.

### a. Conveyance



- Do not hold the headrest, chinrest or LCD monitor because it can result in deformation or malfunction of them.
- Do not drag the power cord with being attached to the main unit. It can result in malfunction of the device caused by fall or drop, or personal injury if the cord is stuck or stepped on.

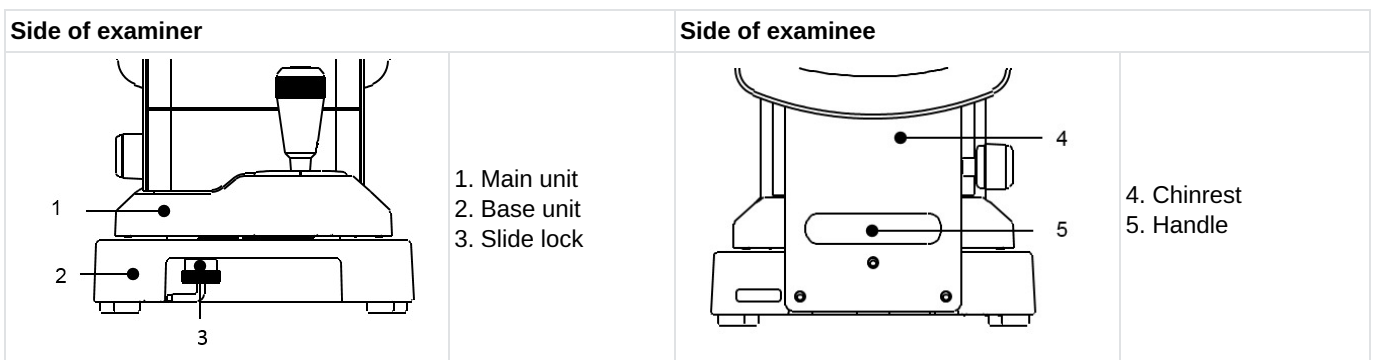

- Before conveyance, move the main unit undermost, set it in the center of the base unit and secure it by tightening the slide lock.
- The slide lock can be tightened by pushing it up and rotating it in counterclockwise direction.
- At the time of conveyance, hold the back and front of the base unit (the cutout of the front side and the handle under the chinrest) with both hands securely.

## b. Reload of printer paper

---

- 1 Push on the printer door button to open the printer paper cover.

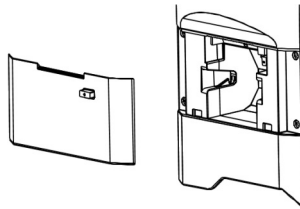

- 2 Pay attention to the direction of the paper rolled and set it in.

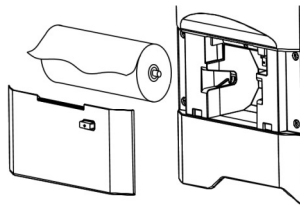

Set the paper as coming out toward the front from the upside.

- 3 Close the printer cover until it clicks.



If the cover is not closed completely, the error message appears and cannot print out.

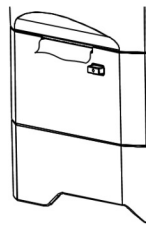

## c. Fuse replacement

---



Unplug the power cord from the unit before removing the fuse holder. You may be in danger of electric shock if removing the fuse holder without unplugging the power cord.

When a fuse is blown, pull out the fuse holder of power plug connector from the main unit and replace the fuse.



Always use the specified fuse (T2A L 250V).

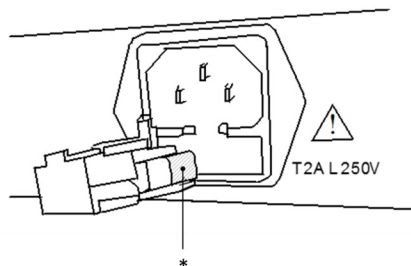

\* Fuse

#### d. Setting of chinrest liner

Set the chinrest liners onto the chinrest, and secure them with the chinrest liner pins.

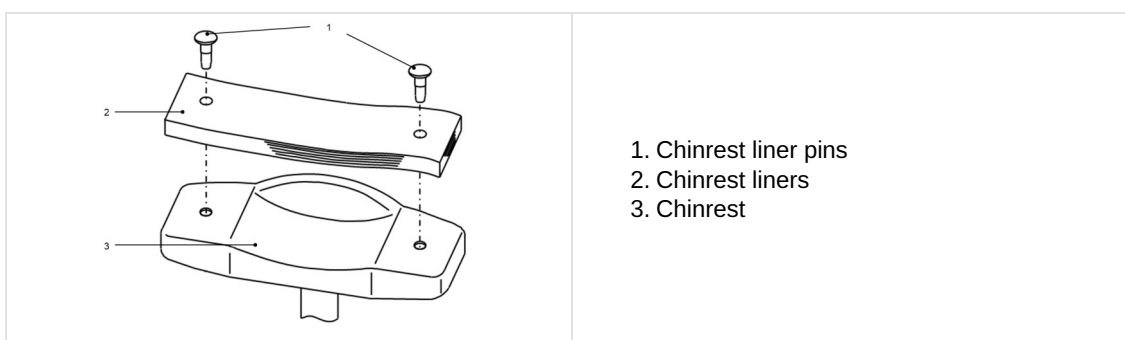

For sanitary reasons, dispose the top chinrest liner after every patient.



Comply strictly with above about the chinrest liners.

- For sanitary reasons, clean the chinrest with the ethanol for cleaning.

Ethanol for disinfection contains 76.9 to 81.4vol% of ethanol (C<sub>2</sub>H<sub>6</sub>O) at 15°C (specific gravity).

#### e. Storage of device

##### 1. Points to check for long-term storage

- Turn OFF the power
- Remove the power cord from the outlet
- Place the main unit undermost
- Secure the main unit by locking the slide lock of the main unit
- Put the dust cover on the main unit

##### 2. Notes about the storage environment

Avoid storage under the following conditions:

- Where dust accumulates
- Where water may get on the unit
- Where temperature and humidity are high
- Where sunlight directly contacts
- Unstable and high place



Check the items above in case that the device is not used or is stored for a long time.

If you use the device after long-term storage, operate it according to the instructions of "VI > 3 > a > Preparation for measurement".

## f. Confirmation of measurement accuracy

It is extremely important to check operation and accuracy of the device with the supplied model eye.

We recommend checking its accuracy periodically.

If the measurement result of the model eye is within the tolerance listed below, the measurement is considered as reliable and accurate. If the result exceeds the tolerance, contact your dealer immediately.

Model eye data		
SPH	CYL	R
Indicated value $\pm 0.25$	$0 \pm 0.25$	Indicated value $\pm 0.03$



The precise value of the supplied model eye is indicated on the model eye stand (VD=12).

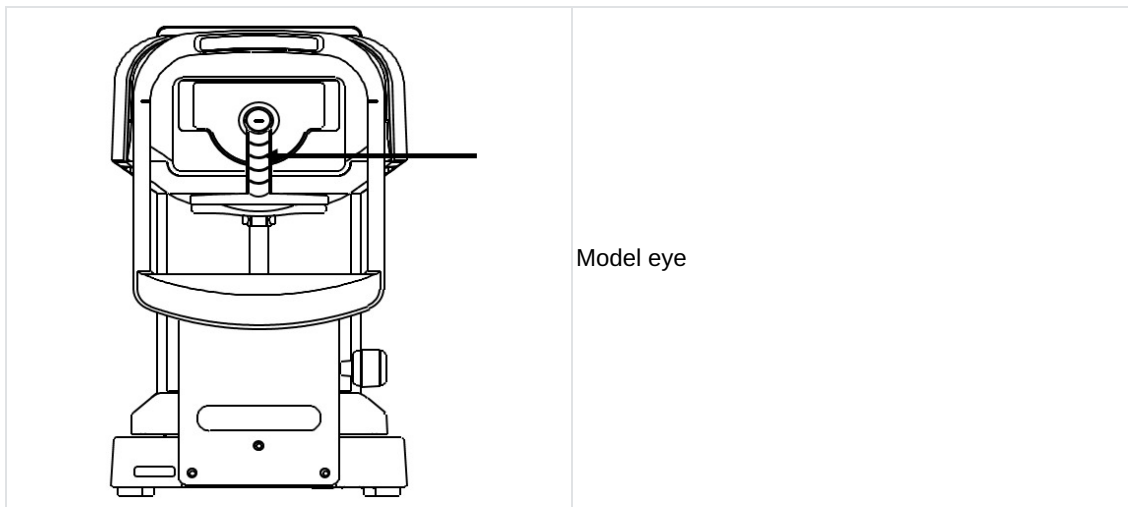

Remove the contact lens holder and set the model eye carefully not to incline back and forth and around. It cannot take CYL value data correctly if the model eye is inclined.



Setting of model eye

- Set the model eye at the position where an alignment mark is located at the center of the reticle mark and the model eye comes into focus.
- When all of the conditions above are met, start the measurement.

## 2. Cleaning instructions



- Unplug the device before cleaning.
- If the device is not used for a long time, remove the power cord from the outlet.
- Never attempt to fix or remodel the device.
- When the device fails to function properly, do not touch the inside.
- If liquid is spilled on the device or a foreign substance is entered in it, unplug the power cord and contact your local distributor.



- This device is a precision optical device. Always handle it with care and do not drop it.
- Do not touch the optical parts, such as a view window, with your hands and be sure to avoid dust because its measurement accuracy could be adversely affected.
- If the measurement unit cover, main unit cover or operation panel is dirty, gently wipe it with a dry cloth.
- For stubborn stains, a little water or neutral cleanser is recommended.
- Clean the chinrest and headrest with the neutral cleanser. For disinfecting the parts especially where the examinee may contact such as the chinrest and headrest, use the ethanol for disinfection.
  - Ethanol for disinfection contains 76.9 to 81.4vol% of ethanol (C<sub>2</sub>H<sub>6</sub>O) at 15°C (specific gravity).
  - The device returned to the manufacturer for repair and maintenance is also disinfected using the same method.
- When the device is not in use, protect it with a supplied dustproof cover. If dust is adhered, it affects its measurement accuracy.



- When dust or fingerprints are on the optical parts, wipe them off with a soft cloth gently. Take great care when cleaning them because they are particularly sensitive and fragile.
- Avoid using organic solvents which will dissolve the water based paint on surface of the device.
- Do not spray chemicals on the device when disinfecting.  
If they get inside the device, it can cause malfunction.

### 3. Periodical inspection and maintenance

To prevent malfunction and accidents and maintain to performance and reliability of the product, it is recommended to request your distributor for the periodical inspection and maintenance once a year.

The periodical inspection and maintenance include inspection of the function and performance of the product, and cleaning, adjustment and replacement of consumable parts if necessary.

It is recommended for the distributors to perform the cleaning of each part, performance check and accuracy check at least once in a year.

- Cleaning of each part: exterior parts and optical system.
- Performance check: main unit and each switch.
- Accuracy check: measurement function of refractive power and corneal curvature radius.

## VIII. ERROR AND TROUBLESHOOTING

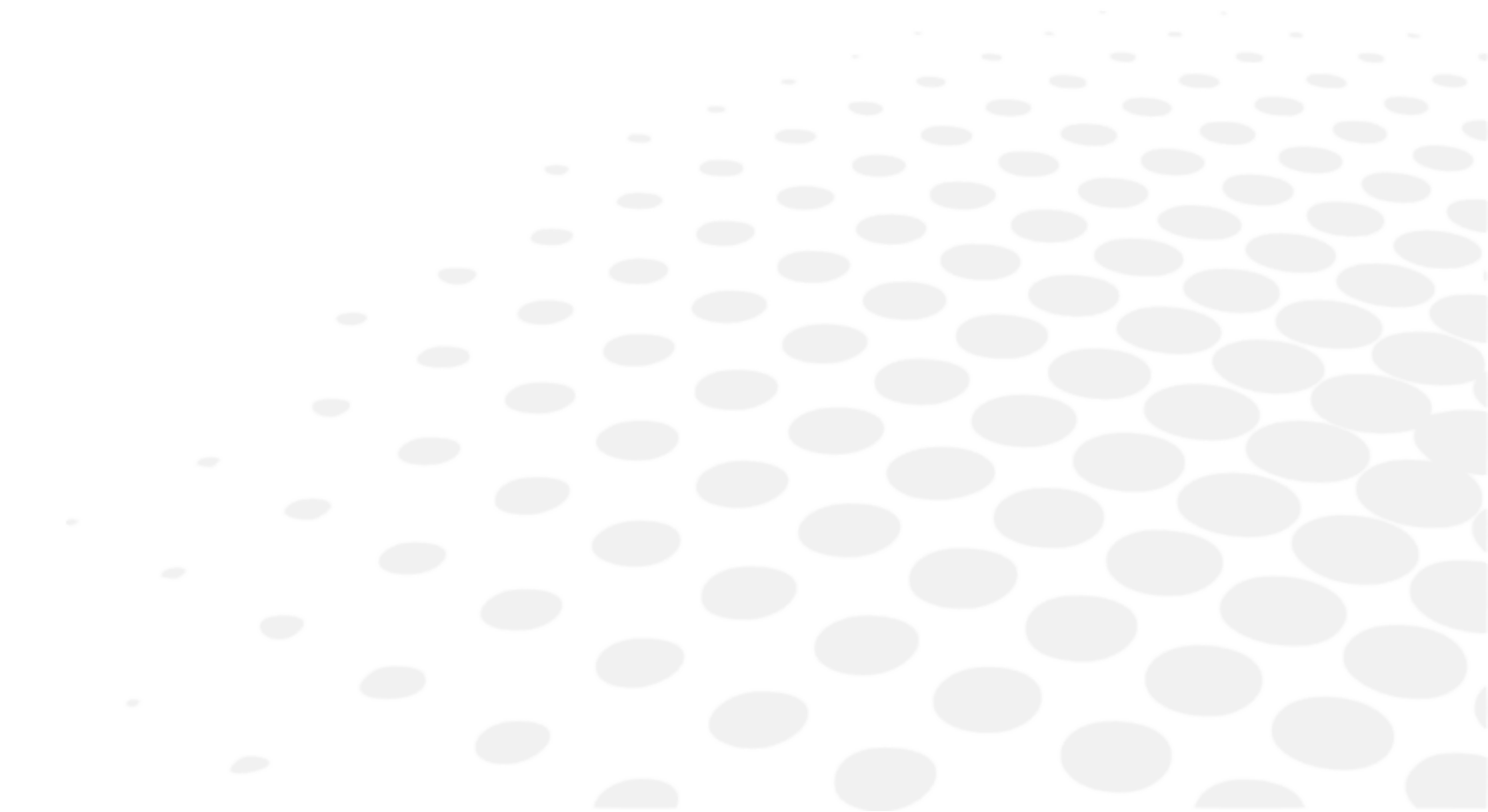

If a problem is detected, refer to the table below in order to take the appropriate measures.

## 1. Error display

Message	Cause	Corrective action
RETRY	Failed to capture eye image because the examinee blinks or moves during measurement or the examined eye has eye diseases	Try alignment precisely and conduct measurement again. Consult your dealer immediately if the message appears again. Do not try to repair it by yourself.
SPH OVER	Exceeded spherical measurement range (-22 to +30D) (In case of VD=0, contact value)	/
CYL OVER	Exceeded cylindrical measurement range (0 to ±10D) (In case of VD=0, contact value)	/
ERR	Exceeded measurement value of pupil diameter (2.0 to 8.5mm)	/
Target motor fault	Detected abnormality in motor control system	Turn OFF the power and turn it back on. Consult your dealer immediately if the message appears again. Do not try to repair it by yourself.
Focus motor fault		
EEPROM fault		
Printer overheated	Printer head is overheated	Turn OFF the power and turn it back on. Consult your dealer immediately if the message appears again. Do not try to repair it by yourself.
Printer cover opened	Printer cover is opened	Close the printer cover properly. Turn OFF the power and turn it back on. Consult your dealer immediately if the message appears even after closing the cover.
Paper empty	No printer paper	Set the printer paper. Refer to "Reload of printer paper".

## 2. Troubleshooting

Symptoms	Causes and measures
The monitor and the power indicator are not turned on.	<ul style="list-style-type: none"> <li>The power cord may not be properly connected. Make sure to connect it securely.</li> <li>The fuse may be blown. If so, replace it with the new one.</li> </ul>
The fuse is blown when the power switch is turned on.	<ul style="list-style-type: none"> <li>Contact your local distributor immediately.</li> </ul>
The monitor display is suddenly disappeared.	<ul style="list-style-type: none"> <li>The saving function may be activated. Press any switch to deactivate the saving function.</li> </ul>
The moving parts such as a joystick are not moving appropriately.	<ul style="list-style-type: none"> <li>Do not move the part forcibly. Contact your local distributor or service person.</li> </ul>
It does not print out.	<ul style="list-style-type: none"> <li>Check if the papers are set. Reload them if the papers are not set.</li> <li>The setting of Print REF/KRT may be set as OFF. Change the setting.</li> </ul>
The printer paper comes out but not printing.	<ul style="list-style-type: none"> <li>The printer paper may be set in a wrong direction. Set the paper properly.</li> </ul>
The date setting is inaccurate.	<ul style="list-style-type: none"> <li>The battery in the device may be run out. Keep the power on for 24 hours and recharge it.</li> </ul>
The packaging of the device is damaged, or the package was unintentionally opened before use.	<ul style="list-style-type: none"> <li>Check the device for proper operation.</li> </ul>

- If liquid is spilled on the device or a foreign substance is entered in it, unplug the power cord and contact your local distributor.
- Cut the power immediately and contact your local distributor if malfunction (noise, smoke etc.) occurs. It can result in fire or injury if you keep using it.
- If malfunction occurs, do not touch the inside of this device. Unplug the power cord and contact your local distributor.

Contact your local distributor immediately if the situation does not improve even after taking the measures mentioned above.

## IX. TECHNICAL DESCRIPTION

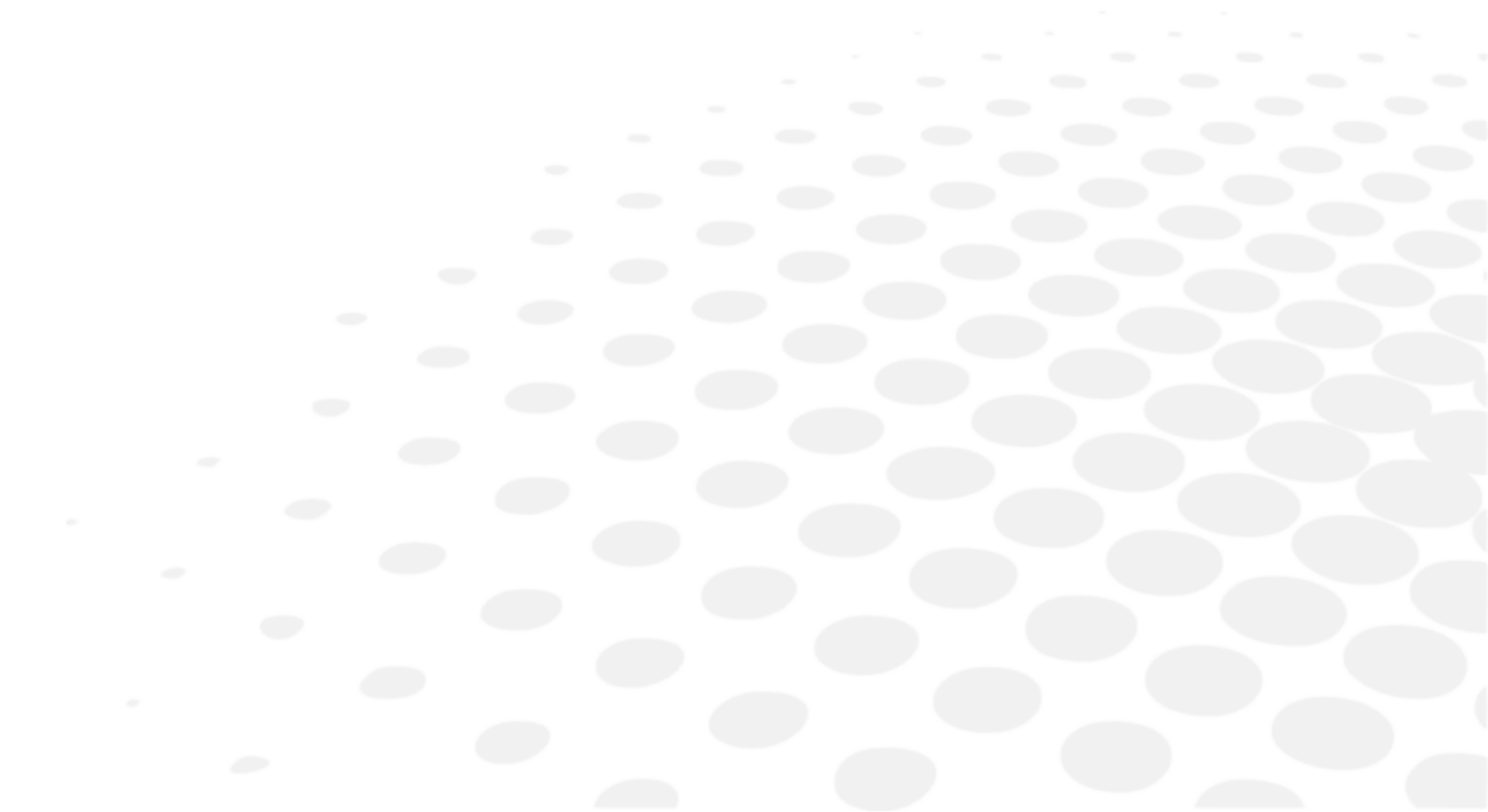



## 1. Technical data

### a. Product life-time

The expected life of the device and its components is 7 years.

### b. Disposal

	<p>When it reaches the end of its lifetime, the instrument should not be thrown out with the household refuse. It can be disposed of at a waste management center operated by the municipality or the retailers who offer this service.</p> <p>Instructions for the disposal of the instrument in accordance with Directives 2012/19/EU and 2011/65/EU regarding the limitation of dangerous substances in electrical and electronic equipment and the disposal of electrical and electronic waste.</p> <p>When it reaches the end of its lifetime, the instrument should not be thrown out with the household refuse. It can be disposed of at a waste management center operated by the municipality or the retailers who offer this service. The separate disposal of an electrical device avoids any damage to the environment or health that could result from a noncompliant disposal, and also allows the materials it is composed of to be recycled in order to save energy and resources. The pictogram of the wheeled container appears on the label of the instrument. It indicates the obligation for separate collection and disposal of end-of-life/out-of-use electrical and electronic equipment.</p>
	<p>Instructions for the disposal of the instrument in accordance with EU Battery Regulation (EU) 2023/1542.</p> <p>The battery is used for the control board to store the information about the date and time. Battery users must dispose of them properly and not dispose of them as unsorted municipal waste.</p> <p>Symbol for separate collection of batteries. If a chemical symbol is printed beneath the symbol shown above, this chemical symbol means that the battery contains a heavy metal at a certain concentration.</p>

### c. Product weight & dimensions

#### Weight

Approx. 13 Kg.

#### Dimensions

- (W): 240 mm
- (D): 422 mm
- (H): 430 mm

### d. Precise performances as intended by Essilor

#### Refractive measurement range

- Sphere (S): -30D to +22D
  - In case of VD=12
  - Step: 0.12/0.25D
- Cylinder (C): 0 to  $\pm 10D$ 
  - Step: 0.12/0.25D
- Axis angle (A): 0 to 180°
  - Step: 1°/5°
- Accuracy: According to EN ISO 10342:2010

**Corneal curvature radius measurement**

- Radius of curvature : 5.0 to 10.0 mm
  - Step: 0.01mm
- Corneal power: 33.75 to 67.5D
  - Corneal Refractive n=1.3375
  - Step: 0.12/0.25D
- Degree of corneal astigmatism: 0 to  $\pm 10$ D
  - Step: 0.12/0.25D
- Axis Angle: 0 to 180°
  - Step: 1°/5°
- Accuracy: According to EN ISO 10343:2014

**Measurement time**

- Refractive measurement: Approx. 0.07 sec.
- Corneal curvature radius: Approx. 0.07 sec.

**Vertex distance**

- 0 mm
- 10 mm
- 12 mm
- 13.5 mm
- 15 mm

**Minimum pupil diameter**

- $\varnothing$  2.0 mm

**PD measurement**

- Measurement range: 0 mm to 85 mm  
Step: 1 mm
- Accuracy: Within  $\pm 1$  mm

**Pupil diameter measurement**

- Measurement range:  $\varnothing$  2.0 mm to 8.5 mm  
Step: 0.1 mm
- Accuracy: Within  $\pm 0.1$  mm

**Printer**

- Thermal line printer  
Paper width: 58mm

**Internal monitor**

- 5.7 inches color LCD monitor (color)

**Shifting range of the sliding body**

- Back/forth:  $\pm 22$  mm
- Right/left:  $\pm 43$  mm
- Up/down:  $\pm 17$  mm

**Vertical adjustment range of chinrest**

- $\pm 30$  mm

---

**e. Precise performances accuracy / function**

---

**Output**

- RS-232C connector

**Power source**

- AC 100 to 240V
- 50/60Hz

**Consumption**

- 60VA

**Power saving function**

- OFF (switchable)
- 3 min (switchable)
- 5 min (switchable)
- 10 min (switchable)

## 2. Electromagnetic compatibility

AKR 550 conforms to the requirements of the EMC (electromagnetic compatibility) standard.

This device complies with EMC standard IEC60601-1-2: 2014+A1:2020, and the expected electromagnetic environment for the entire life cycle is the home healthcare environment.



When using this device in hospitals, do not place it near active HF surgical equipment or in RF shielded rooms with an ME system for magnetic resonance imaging, where the intensity of electromagnetic disturbances is high.



If there is electromagnetic interference stronger than the IEC 60601-1 test level, the following phenomena may occur as a loss / deterioration of performance due to electromagnetic interference:

- Unreliable measurements
- Unavailable measurements
- Incorrect completion of alignment
- Incorrect data output values
- Incorrect display of patient ID



AKR 550 should not be used adjacent to or stacked with other equipment. If adjacent or stacked use is necessary, AKR 550 should be observed to verify normal operation in the configuration in which it will be used.

The use of the accessory, transducer or cable with AKR 550 other than those specified may result in increased emission or decreased immunity of AKR 550.

Do not use equipment that emits electromagnetic waves within 30 cm (12 inch) of any part of AKR 550.

It can result in reduced performance of AKR 550.

### Guidance and manufacturer's declaration - electromagnetic emissions

The [AKR 550] is intended for use in the electromagnetic environment specified below. The customer or user of the [AKR 550] should assure that it is used in such an environment.

Emissions test	Basic EMD standard	Compliance
Conducted and radiated RF emissions	CISPR 11	Class B, Group 1
Harmonic distortion	IEC 61000-3-2	Class A
Voltage fluctuations and flicker	IEC 61000-3-3	Complies

It does not intend to use in aircraft and vehicle.

This device is suitable for use in all establishments, including domestic establishments and those directly connected to the public low-voltage power supply network that supplies buildings used for domestic purposes.

Cable	Connector shield	Cable shield	Ferrite core	Length [m]
Power cord	No	No	No	2.5
RS-232C cable	TBD	TBD	TBD	TBD
Specified Multimedia Equipment Personal computer: Compliant with CISPR 32 Class B				

Immunity test	Basic EMC standard or test method	Immunity test levels Home healthcare environment	Compliance level
Electrostatic discharge	IEC 61000-4-2	± 8kV contact ± 2, 4, 8, 15kV air	± 8kV contact ± 2, 4, 8, 15kV air
Radiated RF EM fields	IEC 61000-4-3	10 V/m <sup>a</sup> 80 MHz to 2.7 GHz 80% AM at 1 kHz	10V/m
Proximity fields from RF wireless communications equipment		See the table below.	
Rated power frequency magnetic fields	IEC 61000-4-8	30 A/m 50 Hz or 60 Hz	30 A/m
Proximity magnetic fields	IEC 61000-4-39	30kHz (8A/m) 134.2kHz (65A/m) 13.56 MHz(7.5A/m)	30kHz (8A/m) 134.2kHz (65A/m) 13.56MHz (7.5A/m)

<sup>a</sup> Before modulation is applied.

Test frequency (MHz)	Band <sup>a</sup> (MHz)	Service <sup>a</sup>	Modulation <sup>b</sup>	Maximum power (W)	Distance (m)	Immunity test level (V/m)	Compliance level
385	380 - 390	TETRA400	Pulse modulation <sup>b</sup> 18Hz	1.8	0.3	27	27
450	430 - 470	GMRS460, FRS460	FM ±5kHz deviation 1kHz sine	2	0.3	28	28
710	704 - 787	LTE Band 13, 17	Pulse modulation <sup>b</sup> 217Hz	0.2	0.3	9	9
745							
780							
810	800 - 960	GSM800/900, TETRA800, iDEN820, CDMA850, LTE Band 5	Pulse modulation <sup>b</sup> 18Hz	2	0.3	28	28
870							
930							
1720	1700 - 1990	GSM1800 ; CDMA1900 ; GSM1900 ; DECT ; LTE Band 1, 3, 4, 25 ; UMTS	Pulse modulation <sup>b</sup> 217Hz	2	0.3	28	28
1845							
1970							
2450	2400 - 2570	Bluetooth, WLAN, 802.11b/g/n, FRID2450, LTE Band 7	Pulse modulation <sup>b</sup> 217Hz	2	0.3	28	28
5240	5100 - 5800	WLAN 802.11a/n	Pulse modulation <sup>b</sup> 217Hz	0.2	0.3	9	9
5500							
5785							

<sup>a</sup> For some services, only the uplink frequencies are included.

<sup>b</sup> The carrier shall be modulated using a 50% duty cycle square wave signal.

Immunity test	Basic EMC standard	Immunity test levels Home healthcare environment	Compliance level
Electrical fast transients/ bursts	IEC 61000-4-4	Input AC power port ± 2kV 100 kHz repetition frequency	± 2kV
		Signal input/ output unit port ±1kV 100 kHz repetition frequency	± 1kV
Surges Line-to-line	IEC 61000-4-5	± 0.5kV, 1kV	
Surges Line-to-ground		± 0.5kV, ± 1kV, ± 2kV	
Conducted disturbances induced by RF fields	IEC 61000-4-6	3 Vrms 0.15 MHz - 80 MHz 6 Vrms in ISM bands between 0.15 MHz and 80 MHz 80% AM at 1 kHz	3 Vrms 6Vrms in ISM bands
Voltage dips	IEC 61000-4-11	0% $U_T$ ; 0.5 cycle 0°, 45°, 90°, 135°, 180°, 225°, 270° and 315°	0% $U_T$ ; 0.5 cycle
		0% $U_T$ ; 1 cycle and 70% $U_T$ ; 25 cycle Single phase: 0°	0% $U_T$ ; 1 cycle 70% $U_T$ ; 25 cycle
Voltage interruptions		0% $U_T$ ; 250 cycle	0% $U_T$ ; 250 cycle

$U_T$  is the AC supply voltage before applying inspection level.



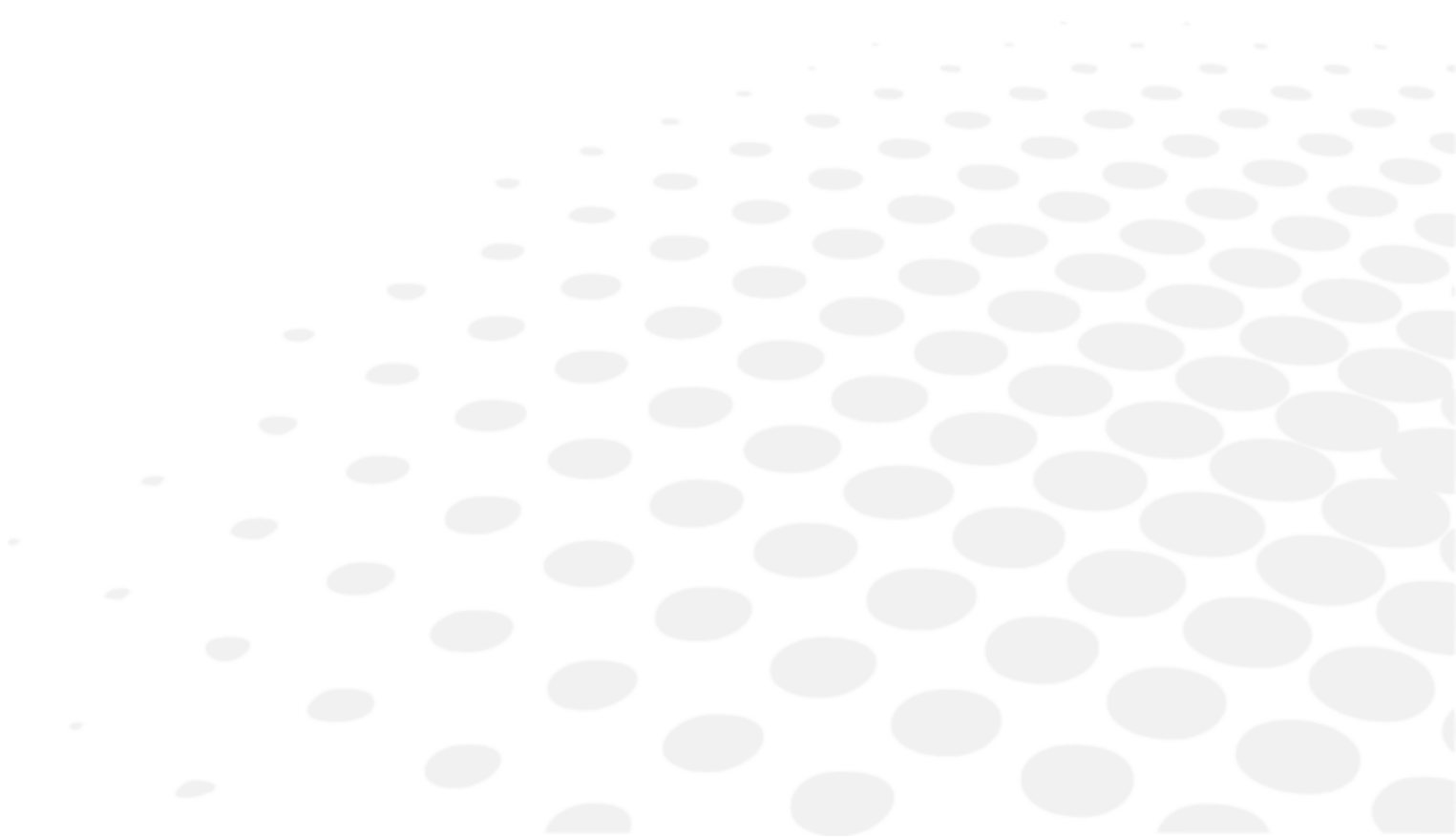

### 3. IT requirements

Please refer to the chapter Cautions and warnings > Product safety > Precautions on IT network. (p.8)















# X. SYMBOL EXPLANATION



## 1. On the document

















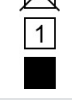

SYMBOL	DESCRIPTION
	Caution: a hazardous situation that, if not avoided, could result in minor or moderate injury.
	Warning: a hazardous situation that, if not avoided, could result in death or serious injury.
	Important and/or useful additional information to learn relating to the text in this manual.
	Tips: practical advice.

## 2. On the device

SYMBOL	DESCRIPTION
	General warning sign
	Obligation to refer to the operation manual
	Serial No.
	Catalog number
	Unique Device Identifier
	OFF = Turned-off (power supply disconnected to the mains)
	ON = Turned-on (power supply connected to the mains)
	Applied, type B parts.
	Manufacturer
	Country of manufacture (JP: JAPAN) Manufacturing date is indicated below in the format YYYY-MM
	CE mark
	Medical device
	Do not mix with regular waste. (2012/19/EU electrical and electronic equipment Waste Directive (WEEE))
	To indicate on the rating plate that the equipment is suitable for alternating current only; to identify relevant terminals.

### 3. On the packaging

For proper handling, storage and transport requirement.

SYMBOL	DESCRIPTION
	Do not mix with regular waste. (2012/19/EU electrical and electronic equipment Waste Directive (WEEE))
	Indicate the thermal limits to which the medical device can be exposed in complete safety
	Indicate the humidity limits to which the medical device can be exposed in complete safety
	Indicate the limits of atmospheric pressure to which the medical device can be exposed in complete safety
	Symbol for Compliant with CE marking i.e. with applicable European directives
	This way up
	Fragile
	Keep dry
	Limiting number of stages loading up to 2 stages
	Stepping prohibited
	Packaging unit To indicate the number of pieces in the package
	Serial No.
	Catalog number
	Unique Device Identifier
	Medical device
	Manufacturer
	Country of manufacture (JP: JAPAN) Manufacturing date is indicated below in the format YYYY-MM
	Symbol for separate collection of batteries. ((EU) 2023/1542) EU Battery Regulation

**XI. EXCLUSION OF LIABILITY**

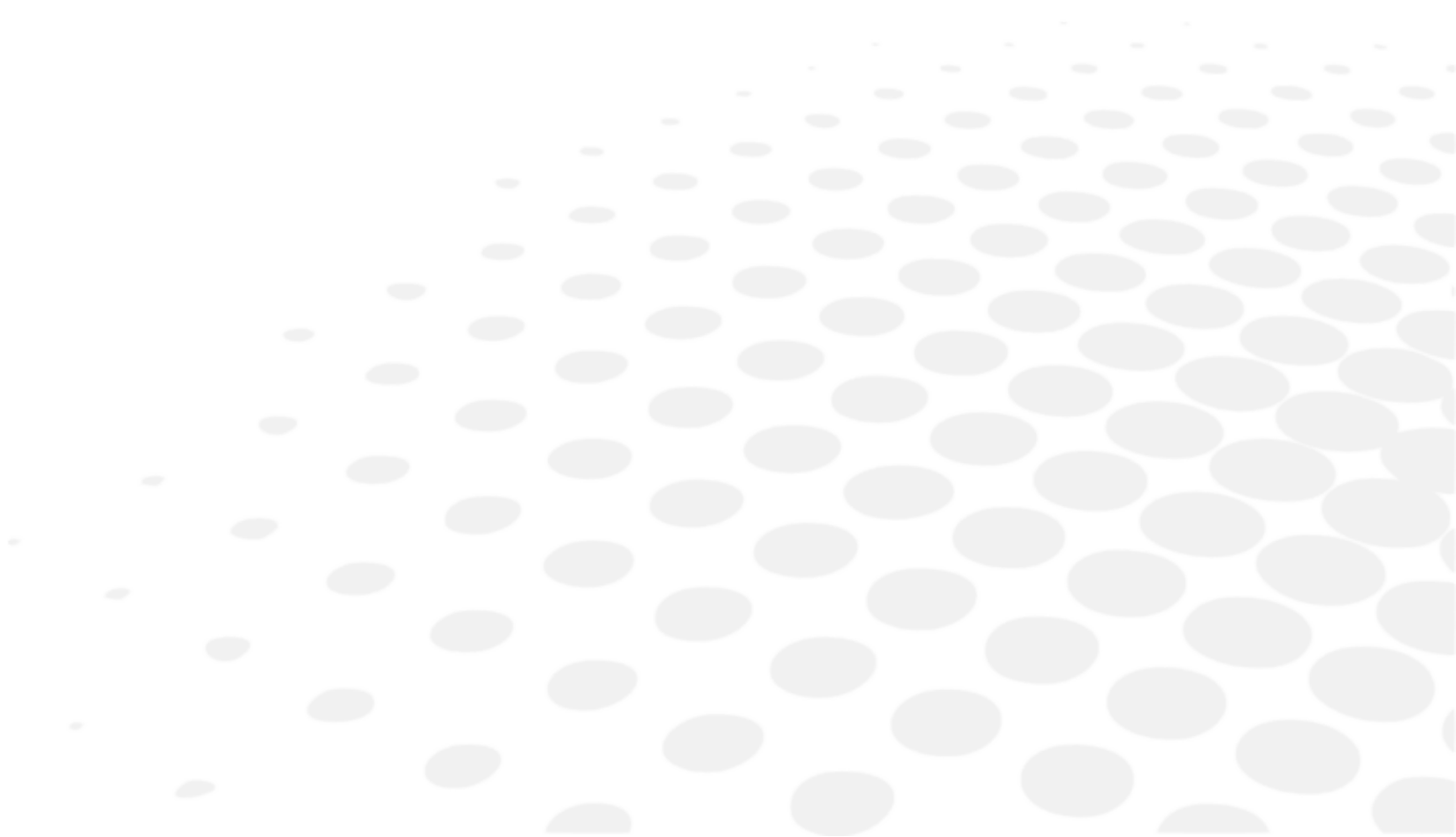

The product shall be used in compliance with the applicable laws and regulations, by qualified, professional users. The product must be installed and used according to the instructions provided in the present user manual and to any written direction or recommendation provided by Essilor (the “documentation”).

Essilor reserves the right to revise the documentation and to make changes in its content from time to time. Preventive and corrective maintenance (including regular calibration, if necessary according to the documentation) shall be performed in accordance with the documentation.

Any product warranty offered by Essilor is contingent upon use of the product in accordance with the documentation and with the product’s intended use and does not cover products that were modified without Essilor’s prior written approval or repaired by a third party not approved by Essilor, nor to products that were subjected to physical, chemical or electrical stress that the products were not originally designed for.

Essilor shall not be held liable for any damages suffered by the user of the product, the product, or any third party, resulting from any user’s non-compliance to the present section.

If the product offers a connectivity function, the user shall be sole responsible for:

- selecting, obtaining and maintaining all required internet access and telecommunications at its own costs; and
- adopting and maintaining procedures and measures to protect its workstations, hardware and software, other than the Product, including against any virus or intrusion

# XII. QR CODE

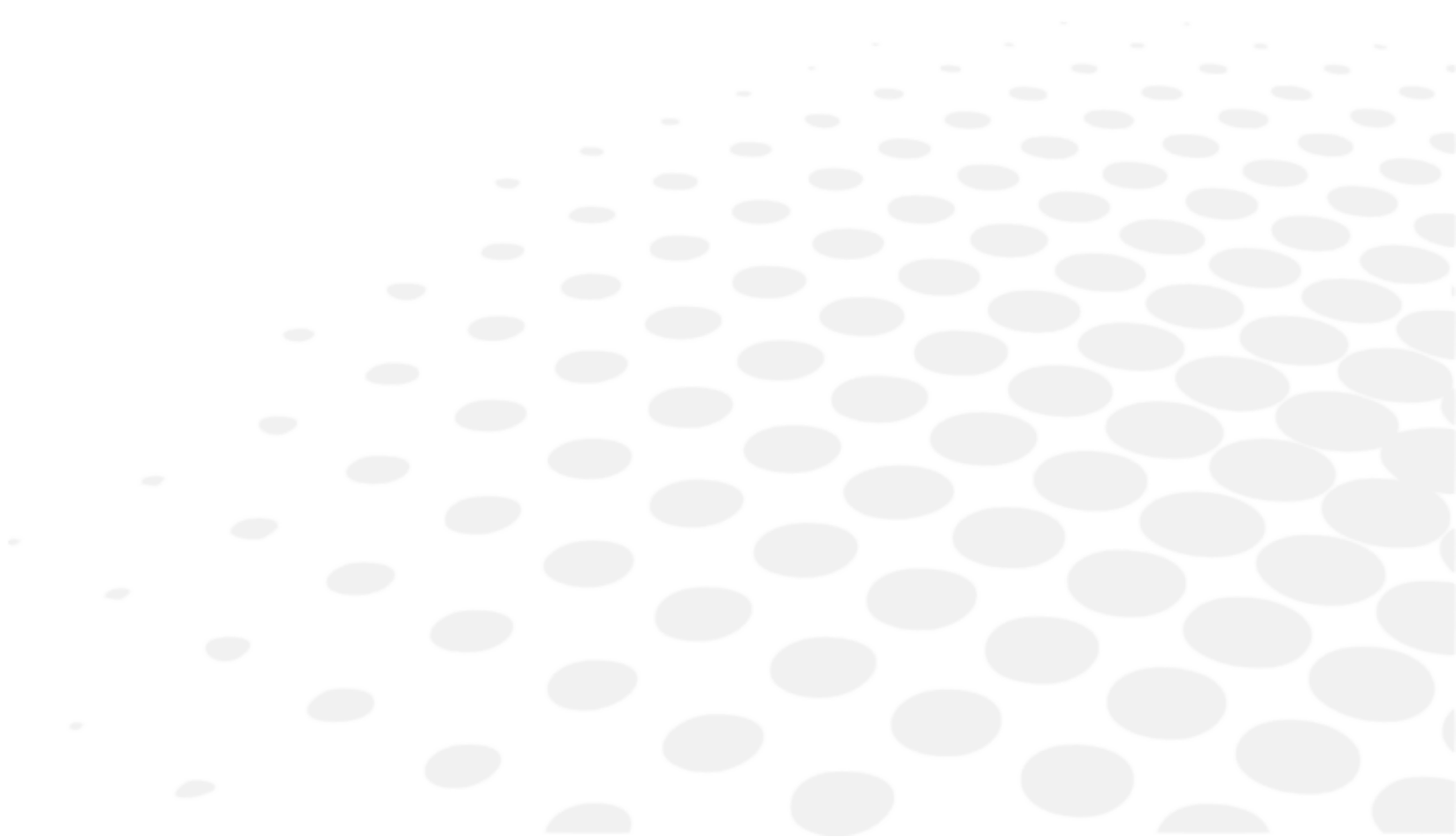

The latest version of the user manual in the appropriate language is available on a web space. Upon request, a paper version can be provided for free.

- en The complete user manual is available on a web space in PDF format. To access it, please scan the QR code below using a dedicated tool or application. Please make sure that your device is suitable and has an appropriate software to display the electronic Instructions for use.
- fr Le manuel utilisateur complet est disponible sur un espace web au format PDF. Pour y accéder, veuillez scanner le QR code ci-dessous à l'aide d'un outil ou d'une application dédié(e). Veuillez vous assurer que votre appareil est compatible et dispose d'un logiciel approprié pour afficher le manuel électronique.
- ar لتمكن من الوصول إليه، يُرجى مسح رمز الاستجابة السريعة PDF دليل المستخدم الكامل متوفر من خلال موقع الويب بصيغة أدناه باستخدام أداة أو تطبيق مخصص لذلك. يُرجى التأكد من أن جهازك مناسب ويحتوي على برنامج مناسب لعرض التعليمات الإلكترونية الخاصة بالاستخدام.
- be Поўная інструкцыя карыстальніка даступна ў інтэрнэт-прасторы у фармаце PDF. Каб атрымаць да яе доступ, адсканіруйце QR-код ніжэй пры дапамозе спецыяльнага сродку або праграмы. Калі ласка, упэўніцеся, што ваша прылада прыдатная для паказу электроннай Інструкцыі па карыстанню і што на ёй усталявана адпаведнае праграмнае забеспячэнне.
- bg Пълното ръководство за потребителя е достъпно в уеб пространството. За да получите достъп до него, моля, сканирайте QR кода по-долу, като използвате специален инструмент или приложение. Моля, уверете се, че вашето устройство е подходящо и разполага с подходящ софтуер за преглед на електронните Инструкции за употреба.
- cs Kompletní uživatelský návod je k dispozici na webovém prostoru ve formátu PDF. Chcete-li k němu získat přístup, naskenujte prosím níže uvedený QR kód pomocí speciálního nástroje nebo aplikace. Ujistěte se prosím, že používáte vhodné zařízení, které má vhodný software pro zobrazení elektronického uživatelského návodu.
- da Den komplette brugervejledning er tilgængelig på et webområde i PDF-format. For at få adgang til den skal du scanne QR-koden nedenfor ved hjælp af et dedikeret værktøj eller program. Sørg for, at din enhed er egnet og har en passende software til at vise de elektroniske brugsanvisninger.
- de Die vollständige Bedienungsanleitung ist auf einem Webspace im PDF-Format verfügbar. Für den Zugriff scannen Sie bitte den untenstehenden QR-Code mit einem speziellen Tool oder einer Anwendung. Bitte vergewissern Sie sich, dass Ihr Gerät für die Anzeige der elektronischen Gebrauchsanweisungen geeignet ist und über eine entsprechende Software verfügt.
- el Το πλήρες εγχειρίδιο χρήσης είναι διαθέσιμο σε έναν ιστοχώρο σε μορφή PDF. Για να αποκτήσετε πρόσβαση σε αυτό, σκανάρετε τον κωδικό QR παρακάτω χρησιμοποιώντας ένα ειδικό εργαλείο ή εφαρμογή. Βεβαιωθείτε ότι η συσκευή σας είναι κατάλληλη και έχει το κατάλληλο λογισμικό για την προβολή των ηλεκτρονικών οδηγιών χρήσης.
- es El manual de uso completo está disponible en un espacio web. en formato PDF. Para acceder a él, escanee el código QR debajo utilizando una herramienta o aplicación dedicada. Asegúrese de que su dispositivo sea adecuado y tenga el software apropiado para mostrar las Instrucciones de uso electrónicas.
- et Täielik kasutusjuhend on saadaval veebis PDF-vormingus. Juurdepääsuks palun skannige allolevat QR-koodi, kasutades selleks vastavat tööriista või rakendust. Veenduge, et teie seade sobib ja et selles on elektroonilise kasutusjuhendi kuvamiseks sobiv tarkvara.
- fi Täysi käyttöopas on saatavana verkosta PDF-muodossa. Saat pääsyn siihen skannaamalla alla olevan QR-koodin käyttäen siihen tarkoitettu työkalua tai sovellusta. Varmista, että laitteesi on sopiva ja sisältää asianmukaisen ohjelmiston sähköisten käyttöohjeiden esittämiseen.
- he למטה באמצעות כלי או QR-כדי לגשת אליו, יש לסרוק את קוד ה PDF המדריך המלא למשתמש זמין באתר אינטרנט בפורמט אפליקציה ייעודיים. חשוב לוודא שהמכשיר שלך מתאים ובעל תוכנה מתאימה להצגת הוראות השימוש האלקטרוניות.
- hr Potpun korisnički priručnik dostupan je na mrežnom prostoru u PDF formatu. Da biste mu pristupili, skenirajte QR kod u nastavku pomoću odgovarajućeg alata ili aplikacije. Provjerite je li vaš uređaj prikladan i ima li odgovarajući softver za prikaz elektroničkih uputa za upotrebu.

hu	A teljes felhasználói kézikönyv elérhető az interneten PDF formátumban. Eléréséhez olvassa be az alábbi QR-kódot egy erre szolgáló eszközzel vagy alkalmazással. Ellenőrizze, hogy eszköze képes és rendelkezik a megfelelő szoftverrel az elektronikus használati útmutató megjelenítésére.
id	Panduan pengguna lengkap tersedia di ruang web dalam format PDF. Untuk mengaksesnya, silakan pindai kode QR di bawah ini menggunakan alat atau aplikasi khusus. Pastikan peranti Anda sesuai dan memiliki perangkat lunak yang layak untuk menampilkan petunjuk penggunaan elektronik.
it	Il manuale utente completo è disponibile in formato PDF su uno spazio Web. Per accedervi, leggere il codice QR sottostante mediante un apposito strumento o un'applicazione dedicata. Assicurarsi che il dispositivo sia adatto e che disponga di un software appropriato per visualizzare le istruzioni per l'uso in formato elettronico.
ja	完全なユーザーマニュアルは、PDF形式でウェブスペースから入手できます。アクセスするには、専用のツールまたはアプリケーションを使用して、以下のQRコードをスキャンしてください。お使いのデバイスが適切であり、電子説明書を表示する適切なソフトウェアがインストールされていることを確認してください。
ko	전체 사용 설명서는 웹 공간에 PDF 형식으로 있습니다. 이 설명서에 액세스하려면, 전용 도구 또는 앱을 사용하여 아래 QR 코드를 스캔하십시오. 사용자의 기기가 적합하고 전자적인 사용 설명서를 표시할 수 있는 적절한 소프트웨어가 있는지 확인하십시오.
lt	Išsamaus naudotojo vadovo PDF formatu ieškokite interneto svetainėje. Kad jį atvertumėte, specialiu įrankiu arba programėle nuskaitykite toliau pateiktą QR kodą. Įsitinkite, kad jūsų įrenginys yra tinkamas ir turi tinkamą programinę įrangą elektroninems naudojimui instrukcijoms rodyti.
lv	Pilnā lietotāja instrukcija ir pieejama tīmeklī PDF formātā. Lai tai piekļūtu, lūdzu, noskenējiet tālāk redzamo kvadrātkodu, izmantojot tam paredzētu rīku vai lietojumprogrammu. Lūdzu, pārliecinieties, vai jūsu ierīce ir piemērota un vai tai ir atbilstoša programmatūra elektroniskās lietotāja instrukcijas attēlošanai.
ms	Manual pengguna yang lengkap boleh didapati di ruang laman dalam format PDF. Untuk mengaksesnya, sila imbas kod QR di bawah menggunakan alat atau aplikasi khusus. Sila pastikan yang peranti anda adalah serasi dan mempunyai perisian yang sesuai untuk memaparkan Arahan elektronik untuk tujuan penggunaan.
mt	Il-manwal tal-utent s'hiñ huwa disponibbli fuq il-web f'format PDF. Biex tačcessah, jekk jogħġbok skennja l-kodiċi QR t'hawn taht permezz ta' għodda jew applikazzjoni apposta. Jekk jogħġbok žgura li l-apparat huwa xieraq u għandu s-software adattat biex juri l-Istruzzjonijiet għall-Użu elettronici.
nl	De volledige gebruikershandleiding is in PDF-formaat beschikbaar op een website. U kunt de handleiding bereiken door de QR-code hiernaast te scannen met een geschikte applicatie. Uw apparaat moet geschikt zijn en over de juiste software beschikken om de elektronische gebruiksaanwijzing weer te geven.
no	Den komplette brukerhåndboken er tilgjengelig på et webhotell i PDF-format. For å få tilgang til den, skann QR-koden nedenfor ved hjelp av et dedikert verktøy eller applikasjon. Sørg for at enheten din er egnet og har en passende programvare for å vise den elektroniske bruksanvisningen.
pl	Kompletna instrukcja użytkownika jest dostępna na stronie internetowej w formacie PDF. Aby uzyskać dostęp, zeskanuj poniższy kod QR przy użyciu dedykowanego narzędzia lub aplikacji. Upewnij się, że urządzenie jest zgodne i wyposażone w odpowiednie oprogramowanie pozwalające wyświetlać elektroniczną Instrukcję obsługi.
pt	O manual do utilizador completo está disponível num espaço online no formato PDF. Para aceder a este, queira digitalizar o QR Code abaixo usando uma ferramenta ou uma aplicação dedicada. Certifique-se de que o seu dispositivo é compatível e possui um software apropriado para exibir as instruções eletrónicas de utilização.
pt (brazil)	O manual do usuário completo está disponível em um espaço online no formato PDF. Para acessar a este, por favor, digitalizar o QR Code abaixo usando uma ferramenta ou um aplicativo dedicado. Seu dispositivo deve ser compatível e possuir um software apropriado para exibir as instruções eletrônicas de utilização.
ro	Manualul de utilizare complet este disponibil online în format PDF. Pentru a-l accesa, scanați codul QR de mai jos folosind un instrument sau o aplicație dedicată. Asigurați-vă că dispozitivul dumneavoastră este potrivit și are un software adecvat pentru afișarea Instrucțiunilor de utilizare în format electronic.
ru	Полное руководство пользователя доступно в интернет-пространстве в формате PDF. Чтобы получить к нему доступ, отсканируйте QR-код ниже с помощью специального инструмента или приложения. Убедитесь, что

ваше устройство подходит и имеет соответствующее программное обеспечение для отображения электронных инструкций по эксплуатации.

sk Celý používateľský manuál je dostupný vo webovom priestore vo formáte PDF. Ak chcete získať prístup, naskenujte nižšie uvedený QR kód pomocou špeciálneho nástroja alebo aplikácie. Uistite sa, že máte vhodné zariadenie s vhodným softvérom na zobrazenie elektronického návodu na použitie.

sl Celoten uporabniški priročnik je na voljo kot dokument PDF na spletnem mestu. Za dostop optično preberite spodnjo kodo QR z namenskim orodjem ali aplikacijo. Prepričajte se, da je vaša naprava primerna in ima ustrezno programsko opremo za prikaz elektronskih navodil za uporabo.

sr Kompletno uputstvo za korisnike je dostupno na veb prostoru u PDF formatu. Da biste mu pristupili, skenirajte QR kôd u nastavku pomoću namenske alatke ili aplikacije. Proverite da je vaš uređaj odgovarajući i da li ima potreban softver za prikaz elektronskog Uputstva za upotrebu.

sv Den fullständiga bruksanvisningen finns tillgänglig på ett webbutrymme i PDF-format. För att komma åt den, vänligen skanna QR-koden nedan med ett dedikerat verktyg eller program. Se till att din enhet är lämplig och har en passande programvara för att visa de elektroniska användningsinstruktionerna.

th สามารถรับคู่มือผู้ใช้ฉบับสมบูรณ์ในรูปแบบ PDF ได้จากบนเว็บไซต์ โดยในการเข้าถึง โปรดสแกนคิวอาร์โค้ดด้านล่างด้วยเครื่องมือหรือแอปพลิเคชันเฉพาะ โปรดตรวจสอบให้แน่ใจว่าอุปกรณ์ของคุณนั้นเหมาะสม และมีซอฟต์แวร์ที่สามารถใช้ในการแสดงคำแนะนำการใช้งานอิเล็กทรอนิกส์ได้อย่างถูกต้อง

tr Kullanım kılavuzunun tamamı web alanında, PDF formatında mevcuttur. Buna erişmek için lütfen uygun bir araç veya uygulama kullanarak aşağıdaki QR kodunu okutun. Lütfen cihazınızın uyumlu ve elektronik kullanım talimatlarını görüntülemek için uygun bir yazılıma sahip olduğundan emin olun.

uk Повна версія посібника користувача доступна в інтернеті в форматі PDF. Щоб отримати до нього доступ, скануйте QR-код нижче за допомогою спеціального додатку. Для перегляду електронного посібника користувача на вашому пристрої він повинен мати відповідні характеристики та програмне забезпечення.

vi Hướng dẫn sử dụng đầy đủ có sẵn trên không gian web ở định dạng PDF. Để truy cập, vui lòng quét mã QR bên dưới bằng công cụ chuyên dụng hoặc bằng ứng dụng. Vui lòng đảm bảo rằng thiết bị của bạn phù hợp và có phần mềm phù hợp để hiển thị Hướng dẫn sử dụng điện tử

zh 完整的操作手册以 PDF 格式在网络上提供。如需获取，请使用专门的工具或应用程序扫描下方二维码。请确保您的设备适用并安装有相应的软件，能够显示电子版使用说明。



# XIII. CONTACT INFORMATION

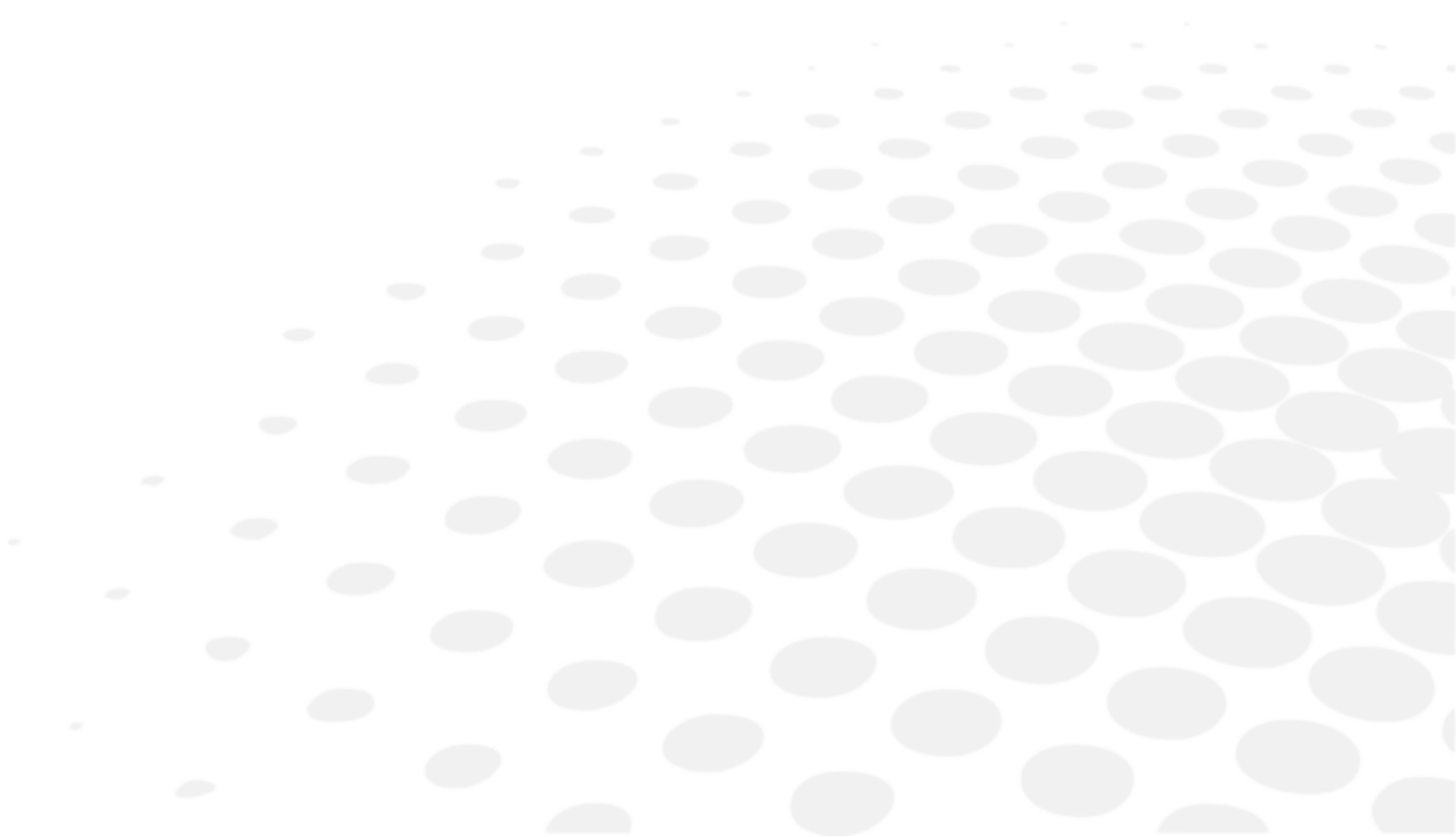

If the instrument appears malfunctioning, it is highly recommended to check the instrument according to the troubleshooting procedure of this manual.

If any problem persists or the instrument is damaged or malfunctioning or it is mentioned to contact your local distributor, please follow the steps below.

- Please contact the local distributor in your province or country at first. All information is available on [www.essilor-instruments.com](http://www.essilor-instruments.com) in the "Contact" section.
- If the product has been provided with electronic instruction and you need a paper format, please contact your local distributor.
- If any serious incident occurred in relation to the device, report it to [essilor-instruments-vigilance@essilor.com](mailto:essilor-instruments-vigilance@essilor.com) and to the local competent authority for medical devices.
- Before calling to the local distributor, please be sure to check Model and Serial Numbers.
- The serial number is unique to this unit and is accessible on the product. It is recommended to fill up the following table as soon as you purchase our product.
- Please keep this manual as a permanent record of your purchase and keep your purchase receipt as your proof of purchase.

Date of Purchase:

-----

Dealer's Name:

-----

Dealer address:

-----

Dealer Phone No.:

-----

Model No.:

-----

Serial No.:

-----



Essilor International  
147, rue de Paris – 94220 Charenton-le-Pont France  
[www.essilor.com](http://www.essilor.com)

