

USER MANUAL

Auto kerato refractometer













Introduction



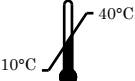

Please read this manual thoroughly so that effective operation is ensured.

- (1) The information contained in this manual is subject to change without notice.
- (2) While reasonable efforts have been made in the preparation of this document to ensure its accuracy, you should contact your local distributor immediately if any quarries arise due to editorial errors or omissions etc.
- (3) If you find any imperfect collating or missing pages, contact your local distributor for replacement.

This manual includes important contents to prevent users or the others from harms and to use this device safely. This device (AKR550) can objectively measure the refractive power of the eye.

Read this manual after understanding the symbols below and follow the instructions in use.

 Warning	This symbol indicates that mishandling as a result of failure to comply with the indications can result in “personal death or serious injury”.
	Denotes general ban or prohibition.
	General mandatory action.
 NOTE	Additional information which is important to the text or useful/ convenient to know.
	Refer to operation manual.
	The number on the left is the lower limit and the one on the right is the upper limit of the temperature.
	The number on the left is the lower limit and the one on the right is the upper limit of the humidity.
	The number of the left indicates the lower limit and on the right indicates the upper limit of the atmospheric pressure.
	Special collection for this type of electrical and electronic device
	Avoid direct sunlight.
	This is the type B equipment.

	Symbol for “MANUFACTURER”.
	Symbol for “AUTHORISED REPRESENTATIVE IN THE EUROPEAN COMMUNITY”.
	This way up.
	Manufacturing date (year)









This manual includes the information about basic operation, inspection and maintenance etc. of AKR550.

This device and the contents of this manual comply with IEC60601-1.

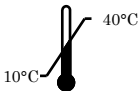
Safety Consideration

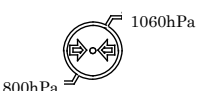
General Cautions

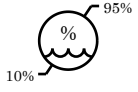
- It affects its measurement accuracy if fingerprints or dust etc. are on the optical parts, such as the lens of the view window. Do not touch them with hands and avoid dust
- If fingerprints or dust are adhered on the optical parts, such as the lens etc, wipe it gently with a soft cloth.
- Observe the following environmental conditions for use and storage.

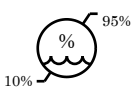
	Temperature	Humidity	Atmospheric pressure.
Use	 10°C to 40°C	 30% to 90%	 800hPa to 1060hPa
Storage	 -10°C to 55°C	 10% to 95%	
Transportation	 -40°C to 70°C	 10% to 95%	

- Avoid installation near TV or radio. The reception can be disturbed by electrical noise.
- If liquid is spilled on this device or a foreign substance is entered in it, unplug the power cord and contact your local distributor.
Cut the power immediately and contact your local distributor if malfunction (noise, smoke etc.) occurs. It can result in fire or injury if you keep using it.
- Do not attempt to disassemble it. It can result in malfunction or fire.
- If malfunction occurs, do not touch the inside of this device. Unplug the power cord and contact your local distributor.

Electromagnetic Compatibility

This product conforms to the EMC Standard (IEC 60601-1-2 Ed. 3.0: 2007).

- a) This product needs special precautions regarding EMC and needs to be installed and put into service according to the EMC information provided in this manual.
- b) Portable and mobile RF communications equipment can affect medical electrical equipment.
- c) The use of accessories, transducers and cables other than those specified, with the exception of transducers and cables sold by the manufacturer of the equipment or system as replacement parts for internal components, may result in increased emissions or decreased immunity of the equipment or system.
- d) The equipment or system should not be used adjacent to or stacked with other equipment. If adjacent or stacked use is necessary, the equipment or system should be observed to verify normal operation in the configuration in which it will be used.
- e) The use of the accessory, transducer or cable with equipment and systems other than those specified may result in increased emission or decreased immunity of the equipment or system.

Guidance and manufacturer's declaration – electromagnetic emissions		
AKR550 is intended for use in the electromagnetic environment specified below. The customer or the user of AKR550 should assure that it is used in such an environment.		
Emissions test	Compliance	Electromagnetic environment – guidance
RF emissions CISPR 11	Group 1	AKR550 uses RF energy only for its internal function. Therefore, its RF emissions are very low and are not likely to cause any interference in nearby electronic equipment.
RF emissions CISPR 11	Class A	AKR550 is suitable for use in all establishments other than domestic and those directly connected to the public low-voltage power supply network that supplies buildings used for domestic purposes.
Harmonic emissions IEC 61000-3-2	Class A	
Voltage fluctuations/ flicker emissions IEC 61000-3-3	Complies	
RF emissions CISPR 14-1		
RF emissions CISPR 15		

Guidance and manufacturer's declaration – electromagnetic immunity			
AKR550 Image Intensifier is intended for use in the electromagnetic environment specified below. The customer or the user of AKR550 Image Intensifier should assure that it is used in such an environment.			
Immunity test	IEC 60601 test level	Compliance level	Electromagnetic environment – guidance
Electrostatic discharge (ESD) IEC 61000-4-2	± 6 kV contact ± 8 kV air	± 6 kV contact ± 8 kV air	Floors should be wood, concrete or ceramic tile. If floors are covered with synthetic material, the relative humidity should be at least 30%.
Electrical fast transient/burst IEC 61000-4-4	± 2 kV for power supply lines ± 1 kV for input/output lines	± 2 kV for power supply lines ± 1 kV for input/output lines	Mains power quality should be that of a typical commercial or hospital environment.
Surge IEC 61000-4-5	± 1 kV differential mode ± 2 kV common mode	± 1 kV differential mode ± 2 kV common mode	Mains power quality should be that of a typical commercial or hospital environment.
Voltage dips, short interruptions and voltage variations on power supply input lines IEC 61000-4-11	<5 % U_T (>95 % dip in U_T) for 0.5 cycle 40 % U_T (60 % dip in U_T) for 5 cycles 70 % U_T (30 % dip in U_T) for 25 cycles <5 % U_T (>95 % dip in U_T) for 5 s	<5 % U_T (>95 % dip in U_T) for 0.5 cycle 40 % U_T (60 % dip in U_T) for 5 cycles 70 % U_T (30 % dip in U_T) for 25 cycles <5 % U_T (>95 % dip in U_T) for 5 s	Mains power quality should be that of a typical commercial or hospital environment. If the user of AKR550 Image Intensifier requires continued operation during power mains interruptions, it is recommended that AKR550 Image Intensifier be powered from an uninterruptible power supply or a battery.
Power frequency (50/60 Hz) magnetic field IEC 61000-4-8	3 A/m	3 A/m	If image distortion occurs, it may be necessary to position AKR550 further from sources of power frequency magnetic fields or to install magnetic shielding. The power frequency magnetic field should be measured in the intended installation location to assure that it is sufficiently low.
NOTE U_T is the a.c. mains voltage prior to application of the test level.			

Guidance and manufacturer's declaration – electromagnetic immunity			
AKR550 is intended for use in the electromagnetic environment specified below. The customer or the user of AKR550 should assure that it is used in such an environment.			
Immunity test	IEC 60601 test level	Compliance level	Electromagnetic environment – guidance
Conducted RF IEC 61000-4-6	3 Vrms 150 kHz to 80 MHz	3 Vrms	Portable and mobile RF communications equipment should be used no closer to any part of AKR550, including cables, than the recommended separation distance calculated from the equation applicable to the frequency of the transmitter. Recommended separation distance $d = 1.2\sqrt{P}$ $d = 1.2\sqrt{P}$ 80 MHz to 800 MHz $d = 2.3\sqrt{P}$ 800 MHz to 2.5 GHz where P is the maximum output power rating of the transmitter in watts (W) according to the transmitter manufacturer and d is the recommended separation distance in meters (m).
Radiated RF IEC 61000-4-3	3 V/m 80 MHz to 2.5 GHz	3 V/m	Field strengths from fixed RF transmitters, as determined by an electromagnetic site survey, ^a should be less than the compliance level in each frequency range. ^b Interference may occur in the vicinity of equipment marked with the following symbol: 
NOTE 1 At 80 MHz and 800 MHz, the higher frequency range applies.			
NOTE 2 These guidelines may not apply in all situations. Electromagnetic propagation is affected by absorption and reflection from structures, objects and people.			
^a Field strengths from fixed transmitters, such as base stations for radio (cellular/cordless) telephones and land mobile radios, amateur radio, AM and FM radio broadcast and TV broadcast cannot be predicted theoretically with accuracy. To assess the electromagnetic environment due to fixed RF transmitters, an electromagnetic site survey should be considered. If the measured field strength in the location in which AKR550 is used exceeds the applicable RF compliance level above, AKR550 should be observed to verify normal operation. If abnormal performance is observed, additional measures may be necessary, such as re-orienting or relocating AKR550.			
^b Over the frequency range 150 kHz to 80 MHz, field strengths should be less than 3 V/m.			

Recommended separation distance between portable and
mobile RF communication equipment and AKR550

AKR550 is intended for use in an electromagnetic environment in which radiated RF disturbances are controlled. The customer or the user of AKR550 can help prevent electromagnetic interference by maintaining a minimum distance between portable and mobile RF communication equipment (transmitters) and AKR550 are recommended below, according to the maximum output power of the communications equipment.

Rated maximum output power of transmitter W	Separation distance according to frequency of transmitter m		
	150kHz to 80MHz $d = 1.2\sqrt{P}$	80MHz to 800MHz $d = 1.2\sqrt{P}$	800MHz to 2.5GHz $d = 2.3\sqrt{P}$
0.01	0.12	0.12	0.23
0.1	0.38	0.38	0.73
1	1.2	1.2	2.3
10	3.8	3.8	7.3
100	12	12	23

For transmitters rated at a maximum output power not listed above, the recommended separation distance d in meters (m) can be estimated using the equation applicable to the frequency of the transmitter, where P is the maximum output power rating of the transmitter in watts (W) according to the transmitter manufacturer.

NOTE 1 At 80 MHz and 800 MHz, the separation distance for the higher frequency range applies.

NOTE 2 These guidelines may not apply in all situations. Electromagnetic propagation is affected by absorption and reflection from structures, objects and people.

Contents

Introduction	1
Safety Consideration.....	3
Electromagnetic Compatibility.....	4
Contents	8
1. Accessories	9
2. Device	10
2.1 General Description of Product	10
2.2 Intended Use Defined	10
2.3 Classification Defined, Rule Given.....	10
2.4 Classification of Device.....	10
2.5 Usage of Product.....	11
2.6 Mode of Operation	11
2.7 Parts Identification.....	12
3. Instructions for Use	13
3.1 Conveyance	13
3.2 Installation	14
3.3 Connection/ Wiring	15
3.4 Maintenance/ Inspection	16
3.5 Disposal.....	16
4. How to Use	17
4.1 Operation Procedure.....	17
4.2 Measurement Flow	18
4.3 Measurement.....	19
4.3.1 Preparation for Measurement.....	19
4.3.2 Power Distribution.....	19
4.3.3 Standby.....	20
4.3.4 Preparation of Examinee.....	21
4.3.5 Alignment	22
4.3.6 Measurement.....	24
4.3.7 Print-out of Measurement Result	25
4.4 Setting of Setup Screen	27
4.5 Scotopic Pupil Size (SPS) Measurement Function	32
4.6 IOL Measurement Function.....	33
4.7 Low Reliability Mark Display Function.....	34
4.8 Output.....	35
4.9 Data Screen Function.....	36
4.10 Power Saving Function.....	37
4.11 Contact Lens: Measurement of Base Curve.....	38
5. Storage and Maintenance	39
5.1 Reload of Printer Paper	39
5.2 Fuse Replacement.....	40
5.3 Setting of Chinrest Liner.....	40
5.4 Storage of Device	41
5.5 Confirmation of Measurement Accuracy	42
5.6 Periodical Inspection and Maintenance.....	42
6. Tip for Effective Measurement	43
7. Error Display.....	44
8. Main Troubles and Troubleshooting.....	45
9. Specifications	46

1. Accessories

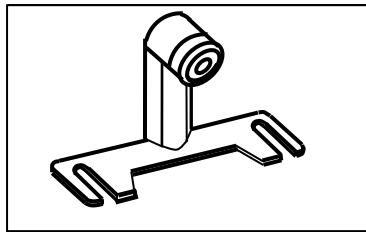

Model Eye: 1
 (With a contact lens holder)
 The diopter value is indicated on the sticker.

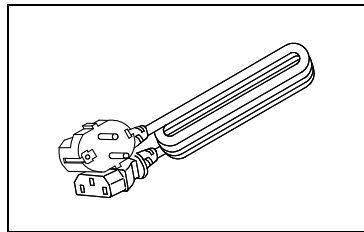

Power Cord: 1
 (2.5m)

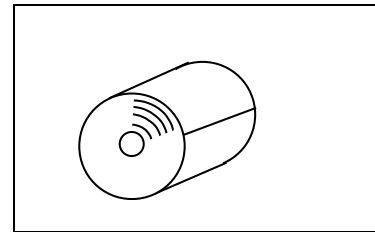

Printer Paper: 3
 (Width: 58mm)
 [2 included and 1 installed in the unit]

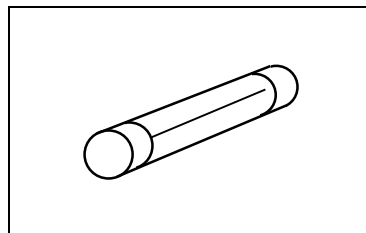

Fuse: 2
 (T2A L 250V)

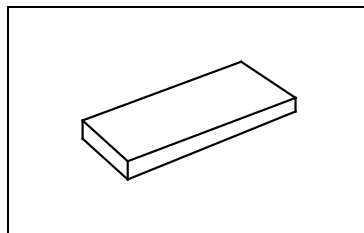

Chinrest Liner: 1
 (1,000 sheets)

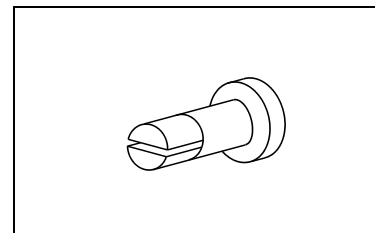

Chinrest Liner Pin: 2

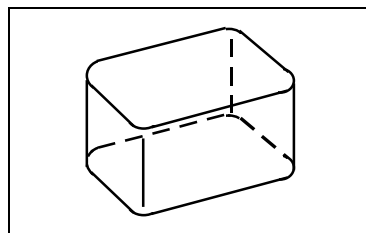

Dust Cover: 1

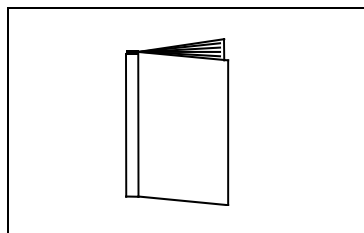

Operation Manual: 1

Name	Model No.	Length
Power cord	KP4819YKS31A	2.5m



Use only the accessories specified by us.

Use of the accessory (power cord) other than specified below may adversely affect other instruments and/or cause malfunction of this device.



Extra care should be taken for storage of a model eye.

Do not store it at where it is dusty or high-temperature and humidity. Avoid direct sunlight, high-temperature and humidity when storing the printer paper because it is a thermal paper.

2. Device

2.1 General Description of Product

This product (AKR550) aims to objectively measure the refractive power of the eye by using the light that is projected to and reflected from the eyeground. It also aims to measure the radius of corneal curvature by using the light that is projected to and reflected from the cornea.

As the feature of this device, the LCD is tilted to the vertical direction and horizontal direction so that the angle can be adjusted.

As for safety consideration, see “3. Instructions for Use” of this manual.

2.2 Intended Use Defined

This product (AKR550) aims to objectively measure the refractive power of the eye by using the light that is projected to and reflected from the eyeground. It also aims to measure the radius of corneal curvature by using the light that is projected to and reflected from the cornea.

Moreover, it can measure the pupil diameter by taking the image of the anterior eye of the examinee.

2.3 Classification Defined, Rule Given

This product is the active device which does not belong to the category of the invasive/ non-invasive device and does not intend the performances below.

Supply of energy / observation of physiological process/ irradiation of ionization radiation/ medication of medicines etc.

Therefore, this is a class I medical device with a measuring function based on the rule 12 of MDD Annex IX.

2.4 Classification of Device

Type of protection against electrical shock: Class I Equipment

Class 1 equipment is equipment in which protection against electric shock does not rely on basic insulation only, but which includes an additional safety precaution in that means are provided for the connection of the equipment to a protective earth conductor in the fixed wiring of the installation in which a way which accessible metal parts cannot become live in the event of a failure of the basic insulation.

Degree of protection against electrical shock: Type B Equipment

Type B equipment provides an adequate degree of protection against electrical shock, particularly regarding allowable leakage currents and reliability of the protective earth connection.



Degree of protection against harmful intrusion of water (IEC 60529): IPX0

This product does not provide protection against intrusion of water.

(The degree of protection against harmful ingress of water defined in IEC 60529 is IPX0.)

Classification by safety of use in air/ flammable anesthetic gas, oxygen or nitrous oxide/ flammable anesthetic gas atmosphere:

- Equipment not suited for use in air/flammable anesthetic gas, oxygen or nitrous oxide/flammable anesthetic gas atmosphere.
- This product should be used in an environment free of flammable anesthetic gas and other flammable gases.

Classification by operation mode: Continuous operation with short-time loading.

2.5 Usage of Product

This product is for medical use which must be used under instructions of a doctor.

2.6 Mode of Operation

This product is for continuous operation. It takes approx. 2 sec. for each measurement.

2.7 Parts Identification

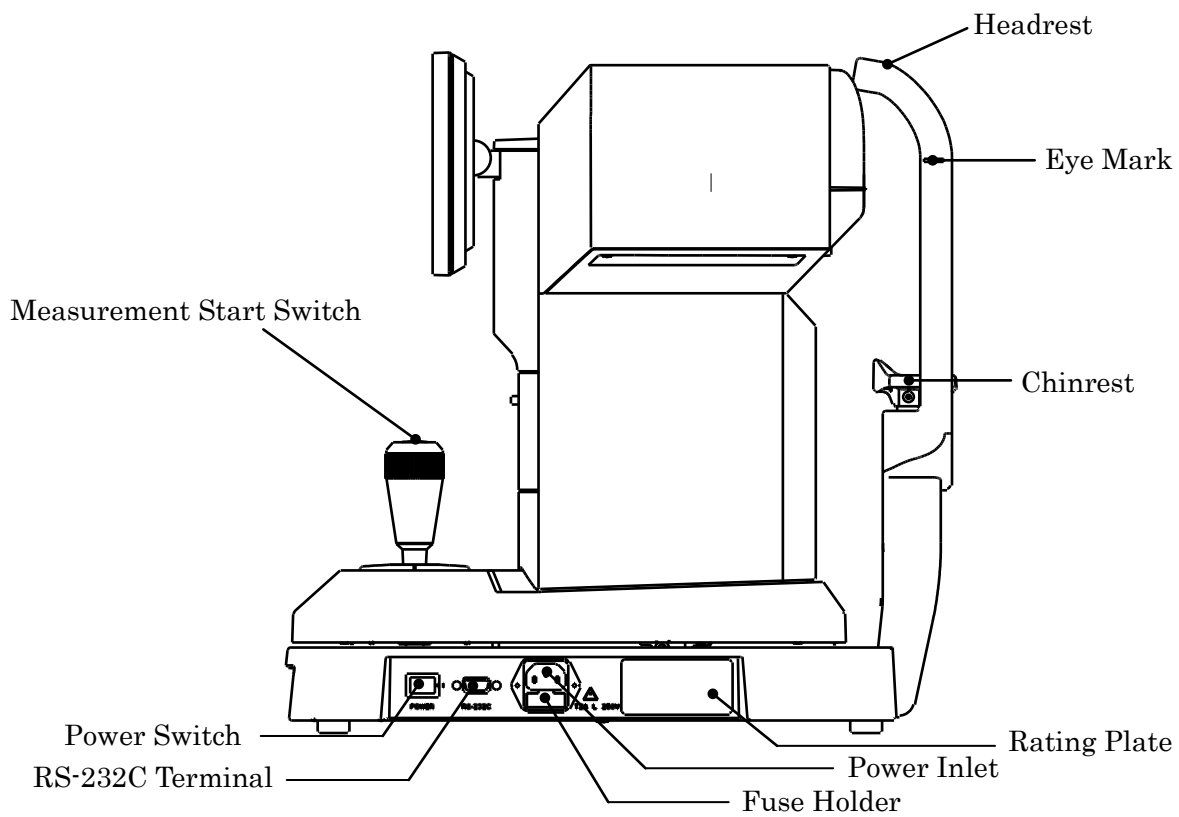
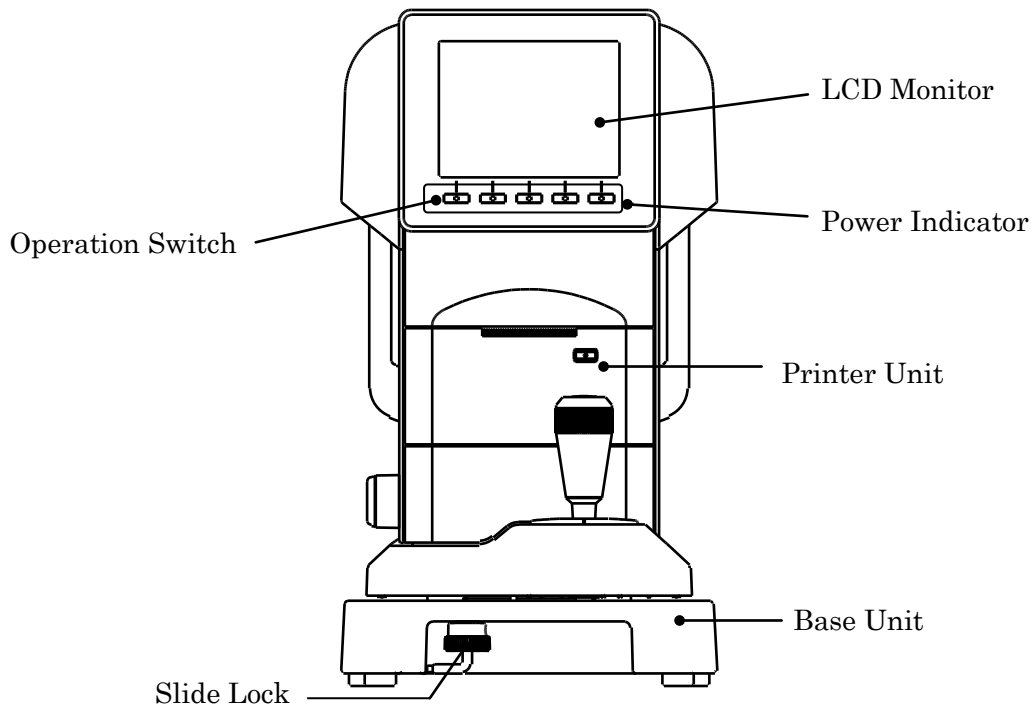

There is the parts list separated from this manual.
 Also there is another parts list related to the safety.

3. Instructions for Use

3.1 Conveyance

- (1) Before conveyance, move the main unit undermost, set it in the center of the base unit and secure it by tightening the slide lock.

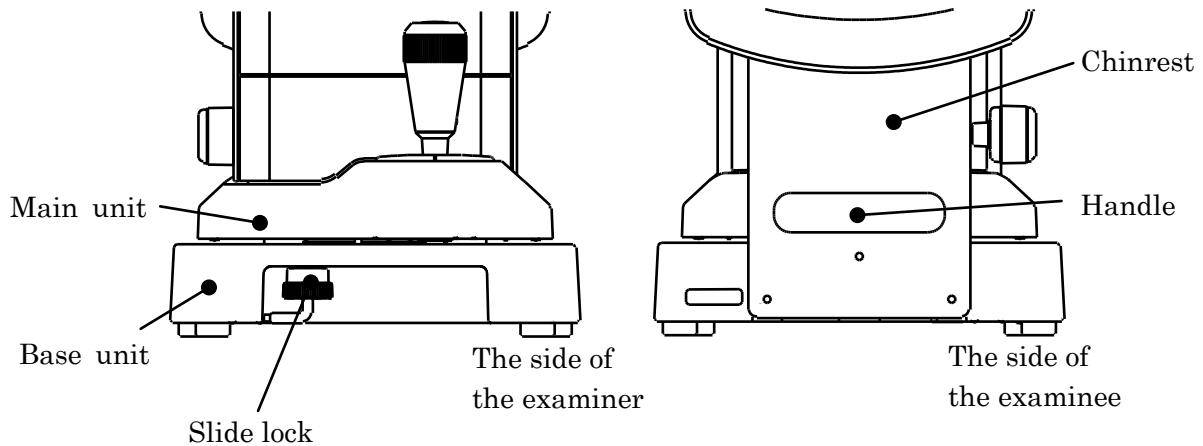

- (2) The slide lock can be tightened by pushing it up and rotating it in counterclockwise direction.
- (3) At the time of conveyance, hold the back and front of the base unit (the cutout of the front side and the handle under the chinrest) with both hands securely. Do not hold the headrest, chinrest or LCD monitor because it can result in deformation or malfunction of them.
- (4) Do not drag the power cord with being attached to the main unit. It can result in malfunction of the device caused by fall or drop, or personal injury if the cord is stuck or stepped on.

3.2 Installation

- (1) Do not expose the view window of the device directly to the sunlight or bright lighting from other sources.

 Great care should be taken because the measurement cannot be carried out if the examinee is exposed to strong light or glare during the measurement and his/her pupil contracts too small.

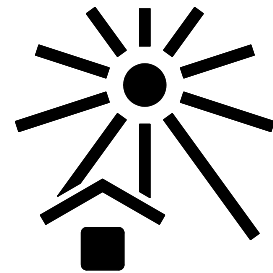

- (2) Do not operate it at the place where it is either dusty or grubby. Environment with extremes in heat and humidity should also be avoided. In case of using the device, fulfill the environmental conditions at the time of unpacking and use.

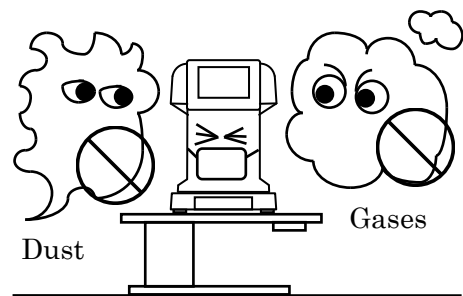

- (3) Keep away from the place which stores chemicals or which emits gas.

- (4) Keep away from the sites which may experience strong vibrations or sudden shocks.

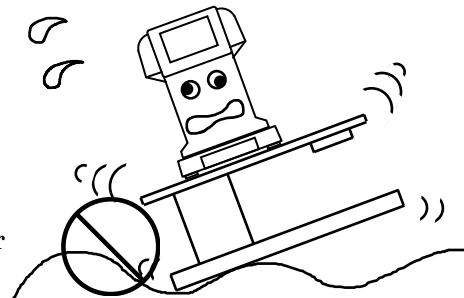

- (5) It can result in malfunction if the device is accidentally overturns. Also, it is very dangerous if it is dropped on your foot etc. Do not store it at the unstable or high place.

3.3 Connection/ Wiring

- (1) Connect the earth cable of the power cord to the earth terminal.
- (2) Do not damage the power cord (folding it small, pulling it or putting a heavy object on it etc.). Also, do not remodel it.
- (3) If the cord is damaged (disconnection, failure of coating etc.), replace it with the new one. It can result in electrical shock or fire.
- (4) Insert the power cord in the outlet and this device securely. If it is not connected securely, it can result in fire or electrical shock.
- (5) Clean the power cord all the time to avoid dust or oil etc. It can result in malfunction or fire if the terminal unit is not clean.
- (6) Check if the terminal unit is dirty when the power cord becomes hot. If it is not dirty, replace it with the new one. It can result in fire or malfunction if you keep using it.
- (7) Use this device with the proper power-supply voltage. If the power-supply voltage is excess, it can result in malfunction or fire.
- (8) Hold the plug unit when plugging in and out.
- (9) Do not touch the power plug with wet hands. It can result in electrical shock.
- (10) Plug out the power cord when it is not used for a long time.

3.4 Maintenance/ Inspection

- (1) This device is a precision optical device. Always handle it with care and do not drop it.
- (2) Do not touch the optical parts, such as a view window, **with your hands** and be sure to avoid dust because its measurement accuracy could be adversely affected.

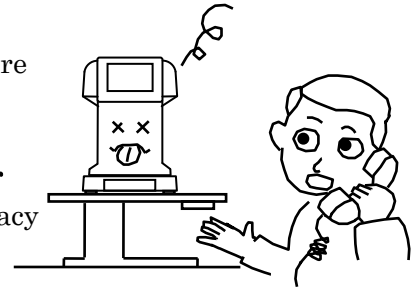

 When dust or fingerprints are on the optical parts, wipe them off with a soft cloth gently. Take great care when cleaning them because they are particularly sensitive and fragile.

- (3) If the measurement unit cover, main unit cover or operation panel is dirty, gently wipe it with a dry cloth. For stubborn stains, a little water or neutral cleanser is recommended.

 Avoid using organic solvents which will dissolve the water based paint on surface of the device.

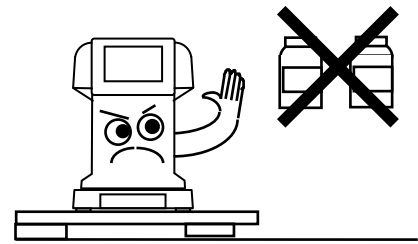

- (4) Clean the chinrest and headrest with the neutral cleanser. For disinfecting the parts especially where the examinee may contact such as the chinrest and headrest, use the ethanol for disinfection.

※ Ethanol for disinfection contains 76.9 to 81.4vol% of ethanol (C₂H₆O) at 15°C (specific gravity).

Basically, it is not necessary to replace the chinrest and headrest rubber. They comply with ISO 10993-1.

- (5) If the device is not used for a long time, remove the power cord from the outlet.
- (6) When the device is not in use, protect it with a supplied dustproof cover. If dust is adhered, it affects its measurement accuracy.
- (7) Never attempt to fix or remodel the device. When the device fails to function properly, **do not touch the inside**. Contact us or the place of purchase.

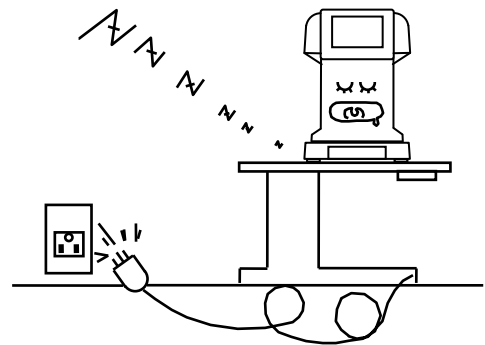

3.5 Disposal

Dispose this device according to the regulations of each local government.

Follow the disposal procedures of each local government when disposing the lithium batteries used in this device. Check the procedures before disposal.

The lithium battery is used for the control board to store the information about the date and time. Basically it is not necessary to replace it because it is rechargeable.

Separate the packaging materials and accessories according to the instructions of each local government.

4. How to Use

4.1 Operation Procedure

The operation switches under the monitor correspond to the icons displayed on the bottom of the monitor.

For usual measurement, the operating switches correspond to the icons as shown below.

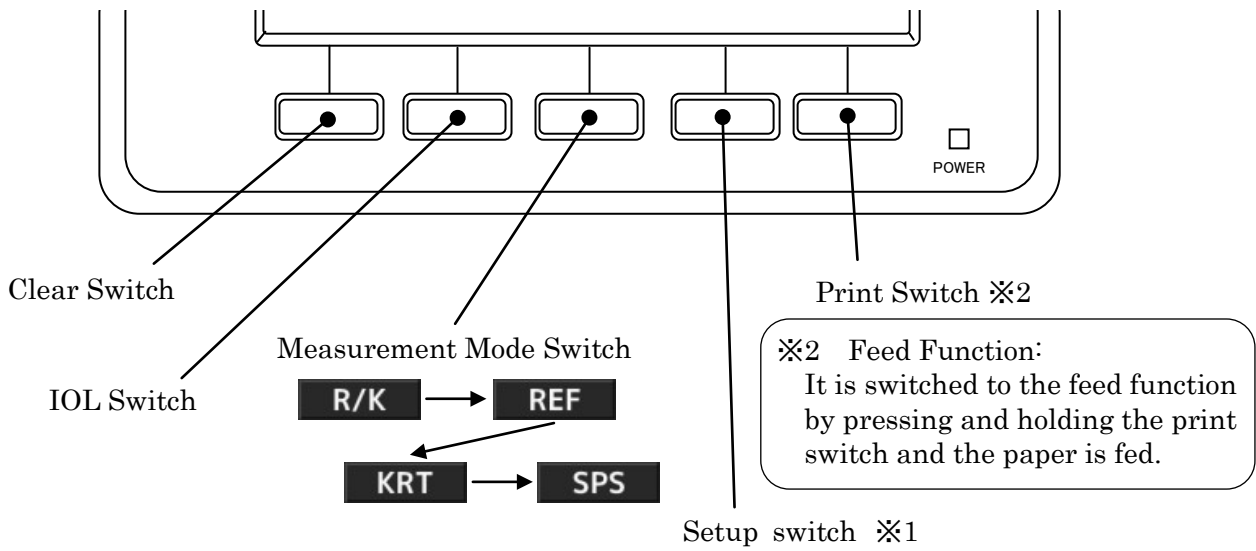

※1 Start method switching function:
The start method (START items on the setup screen: Auto-Quick/Auto/Manual) can be switched on the measurement screen by pressing and holding the setup switch.

Operation Instructions of Joystick

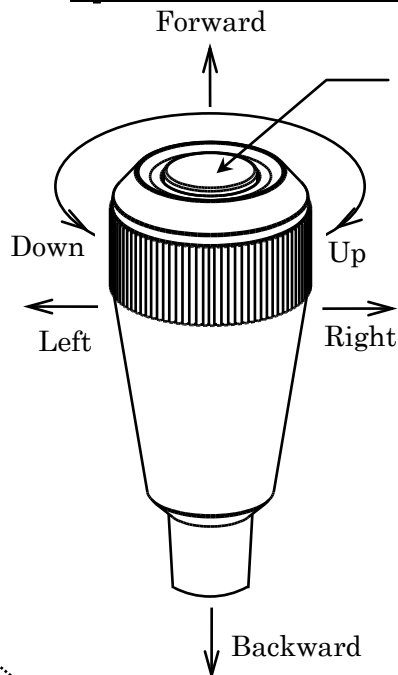

- When moving the joystick forward, the measurement unit moves to the side of the examinee.
- When moving the joystick backward, the measurement unit moves to the side of the examiner.
- When moving the joystick to the right or the left, the measurement unit moves to the right or the left (respectively).
- When rotating the joystick to the right, the measurement unit moves up and when rotating the joystick to the left, the measurement unit moves down.

4.2 Measurement Flow

Procedure	Process	Reference Section	Relevant Section
1	Prepare for measurement ↓	4.3.1	
2	Power distribution ↓	4.3.2	
3	Ask an examinee to ready for a measurement ↓	4.3.4	(4.4 Setting of Setup Screen) (5.2 Fuse Replacement) (5.3 Setting of Chinrest Liner)
4	Alignment ↓	4.3.5	(6 Tip for Effective Measurement)
5	Take a measurement ↓	4.3.6	(7 Error Display)
6	Print out the measurement result ↓	4.3.7	(5.1 Reload of Printer Paper)
7	Switch right/left eye of the examinee OR switch the examinee ↓	Go to the procedure 3	
8	Storage of the device	5.4	

This device has the auto/manual measurement switch function. In case of the auto measurement, the measurement is started automatically after alignment is achieved. In case of the manual measurement, on the other hand, the measurement is started by pressing the measurement start switch.



The measurement can be started manually by pressing the measurement start switch even when the setting of Start is either “Auto” or “Auto-Quick”.

4.3 Measurement

4.3.1 Preparation for Measurement

- (1) Do not place the device at where outside light exposes it directly from the examinee side.
- (2) Make sure that the printer paper, the fuse and the chinrest liner are installed properly.
- (3) Refer to “5.1 Reload of Printer Paper”, “5.2 Fuse Replacement” or “5.3 Setting of Chinrest Liner” of “5. Storage and Maintenance” of this manual for the installation procedures of the parts of (2) above.
- (4) After distributing the power, rotate the slide lock of the main unit (under the base unit) and release the main unit.

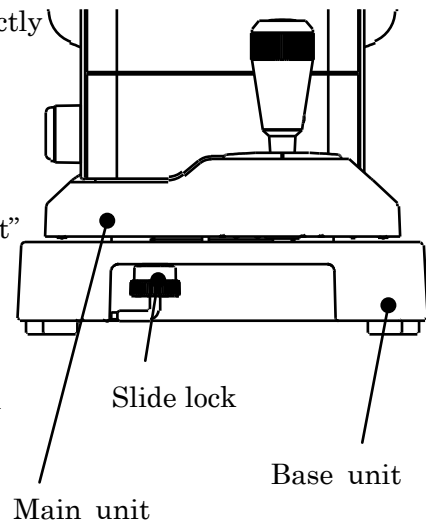

4.3.2 Power Distribution

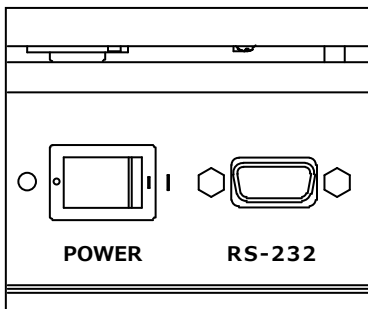

- (1) Make sure that the power switch of the main unit is OFF (○).

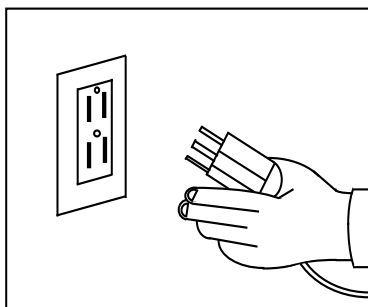

- (2) Insert the power cord in the power plug connector of the main unit and insert the power plug in a socket.

! Always make sure that the cable is grounded.

⊘ Do not use an additional power strip or an extension cord.

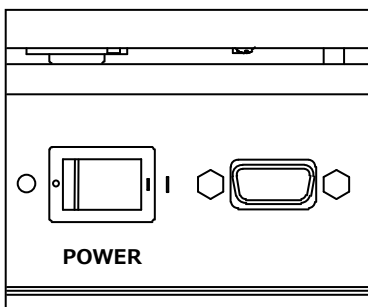

- (3) Turn on the power switch (|) of the main unit.

4.3.3 Standby

When the power is turned on, the screen as shown below appears on the LCD monitor, which is ready for the measurement.

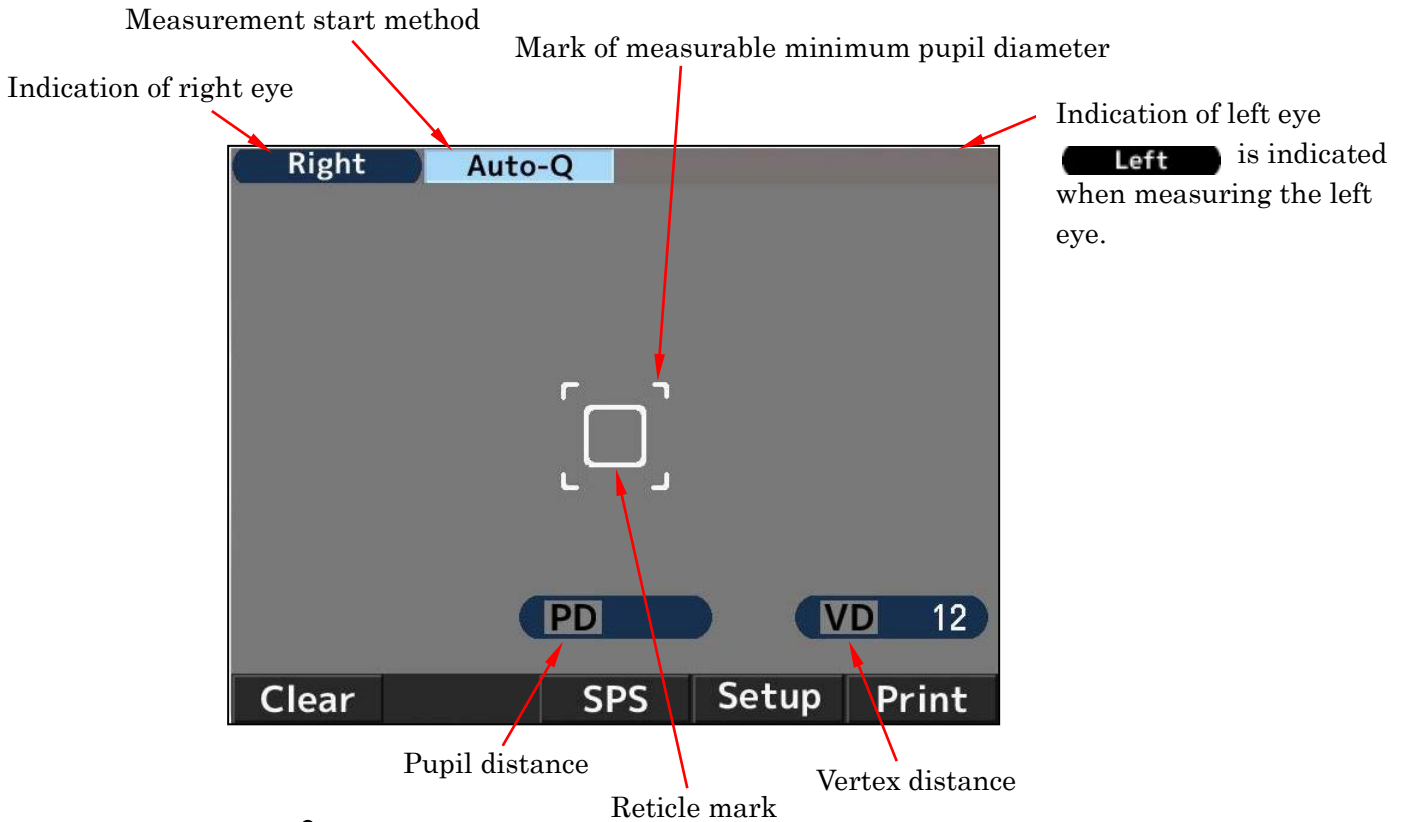

Icon Description

Icon	Function
Right Left	Indicate the eye (right or left) in process of measurement.
Auto-Q Auto	Indicate the measurement start method.
VD 12	Indicate the vertex distance. It can be switched between 0, 10, 12, 13.5 and 15mm.
Clear	Clear the measurement results (values).
IOL	Switch ON and OFF of the IOL mode.
R/K	It switches the measurement mode. There are 4 measurement modes: refractive and keratometry continuous measurement, refractive measurement, keratometry measurement and scotopic pupil size measurement.
Setup	It is switched to the setup screen.
Print	Display and print out the measurement result.

4.3.4 Preparation of Examinee

- (1) Clean the chinrest and dispose one chinrest liner on the top.



Clean the chinrest with the neutral cleanser when there is no chinrest liner.
For disinfecting the chinrest, use the ethanol.

※ Ethanol for disinfection contains 76.9 to 81.4vol% of ethanol (C₂H₆O) at 15°C (specific gravity).

- (2) Ask the examinee to put his/her chin on the chinrest. Adjust the height of the chinrest so that the examinee's eye level is in line with the eye mark.
- (3) Uncomfortable posture may fatigue the examinee during the measurement. Adjust the chinrest or the device to avoid it.
- (4) It affects its measurement accuracy if the examinee moves his/her head during the measurement. Ask him/her to fix his/her forehead on the headrest and look at the target with a good posture.
- (5) Talk to the examinee fluently and try not to make him/her nervous.



Uncomfortable posture may fatigue the examinee during the measurement.

Adjust the height of the optical table or the chair to avoid it.

4.3.5 Alignment

There are 3 types of startup procedures (Auto Quick, Auto and Manual) for AKR550. It can be switched in Start of the Setup screen.

- In case of Auto Quick or Auto
(It starts measurement automatically when it brings the subject eye into focus.)

- 1) Look for the subject eye by operating the joystick.
The Kerato ring appears as bringing it into focus.

NOTE If the eyelid is over the Kerato ring, urge the examinee to open his/her eye wider.

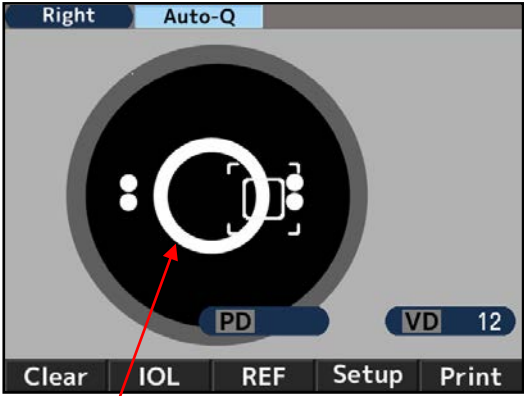

Kerato ring Reticle mark

- 2) The alignment mark (+) will appear as aligning the reticle mark with the center of the pupil of the subject eye and bringing it into focus. Operate the joystick in such a way that the alignment mark (+) comes to the center of the reticle.

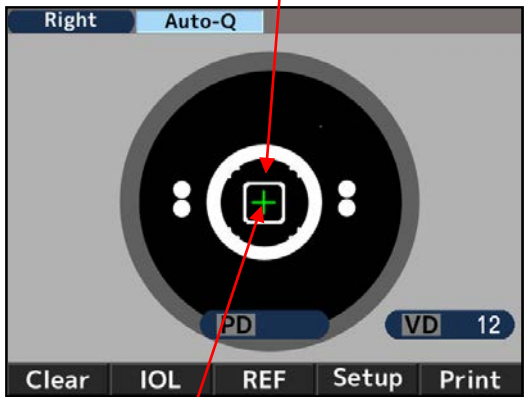

Alignment mark

- 3) Operate the joystick so as to bring it into focus as aligning the alignment mark (+) with the center of the reticle mark. The measurement is started when alignment is achieved and the mark of the measurable minimum pupil diameter is changed to green.

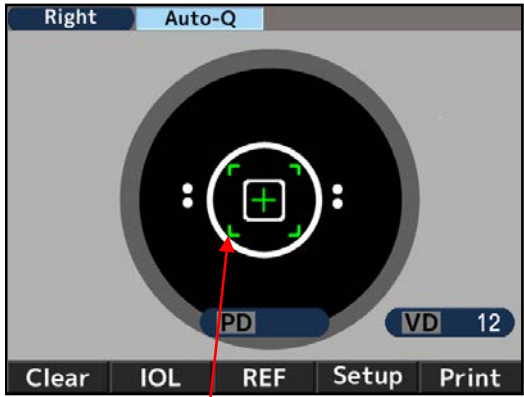

Mark of measurable minimum pupil diameter

- 4) The measurement values are displayed when the measurement is finished. The arrows are displayed when the specific times of measurement is finished. Move the main unit to the direction of the arrows and take a measurement of the other eye.



• In case of Manual

- 1) Look for the subject eye by operating the joystick. The Kerato ring appears as bringing it into focus.

NOTE If the eyelid is over the Kerato ring, urge the examinee to open his/her eye wider.

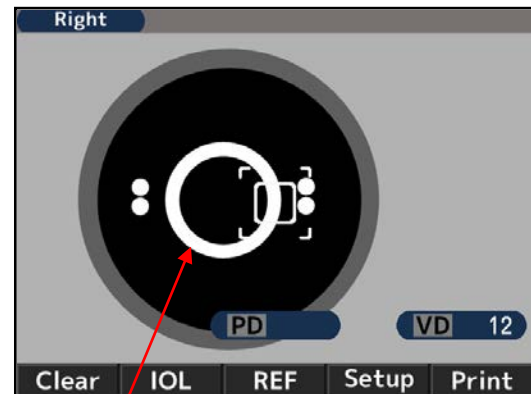

Kerato ring Reticle mark

- 2) The alignment mark (+) will appear as aligning the reticle mark with the center of the pupil of the subject eye and bringing it into focus. Operate the joystick in such a way that the alignment mark (+) comes to the center of the reticle.

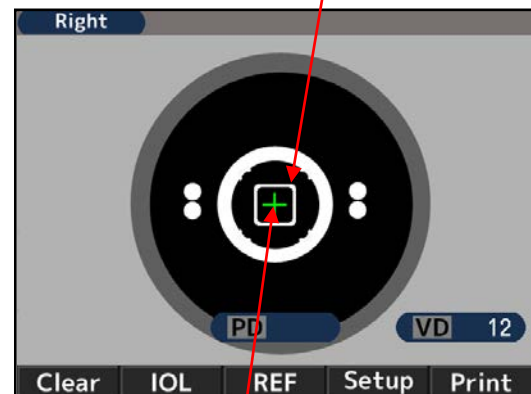

Alignment mark

- 3) Operate the joystick so as to bring it into focus as aligning the alignment mark (+) with the center of the reticle mark. Start the measurement when alignment is achieved and the mark of the measurable minimum pupil diameter is changed to green.

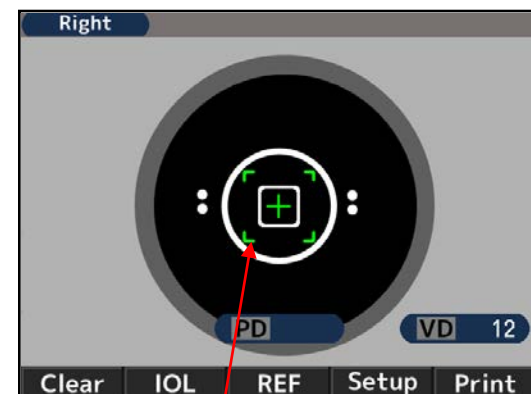

Mark of measurable minimum pupil diameter

4.3.6 Measurement

The measurement start method is different depending on the setting.

Setting	Measurement start method
The setting of Start is either “Auto-Quick” or “Auto”	The measurement is started automatically when alignment is achieved.
The setting of Start is “Manual”	Start the measurement by pressing the start switch when alignment is achieved.

e.g.) Measurement result on the LCD monitor

Refer to the comments about the symbols on the screen.

Number of refractive measurement

Refractive measurement value
S: Spherical value
C: Cylindrical value
A: Axis angle

Number of Kerato measurement

Kerato measurement value
R1: Radius of curvature (Max.)
R2: Radius of curvature (Min.)
AX: Axis Angle

Photopic pupil diameter measurement result

Vertex distance

Pupillary distance (Near vision)

Pupillary distance (Far vision)

- ※ The PD value is indicated after the refractive power of both right and left eyes are measured. The order of the eye to be measured is not important.
- The NPD value is indicated only if the number of “W-D (cm)” on the Setup screen is set.

4.3.7 Print-out of Measurement Result

The measurement result can be printed out by pressing the print switch after the measurements. A maximum of the data for each eye can be saved and the most reliable value among them is indicated as the optimum value. The optimum value is printed out only when more than three times of measurement is taken for each eye. The format of the output (All, All/Eco, Eco or Off) can be set on Print REF/KRT on the setup screen.

- ※ All :Print out a maximum of ten data of the refractive measurement and Kerato measurement for each eye.
- ※ All/Eco :Print out a maximum of ten data of the refractive measurement for each eye. Print out only the optimum values for the Kerato measurement.
- ※ Eco :Print out only the optimum values for all of the measurement.
- ※ Off :Print out no data

<Sample of Printout 1>

Print REF/KRT setting : Eco

```

NAME
2011 11 22      14:30
VD=12
<R> SPH   CYL  AX
- 3.87 -0.75 172
<R>  mm    D   AX
R1  8.33  40.50 175
R2  8.20  41.12  85
AVE  8.26  40.75
CYL      -0.62 175
<L> SPH   CYL  AX
- 3.75 -1.12  14
<L>  mm    D   AX
R1  8.37  40.37   8
R2  8.12  41.50  98
AVE  8.25  40.87
CYL      -1.13   8
PD =  70
AKR550
    
```

- Date and time of the measurement
- Refractive measurement result (optimum value)
 - SPH : Spherical value
 - CYL : Cylindrical value
 - AX : Axis angle
- Kerato measurement result (optimum value)
 - R1 : Radius of curvature (Max.)
 - R2 : Radius of curvature (Min.)
 - AVE : Average of R1 and R2
 - CYL : Cylindrical value
- Pupillary distance

<Sample of Printout 2>
Print REF/KRT setting: All

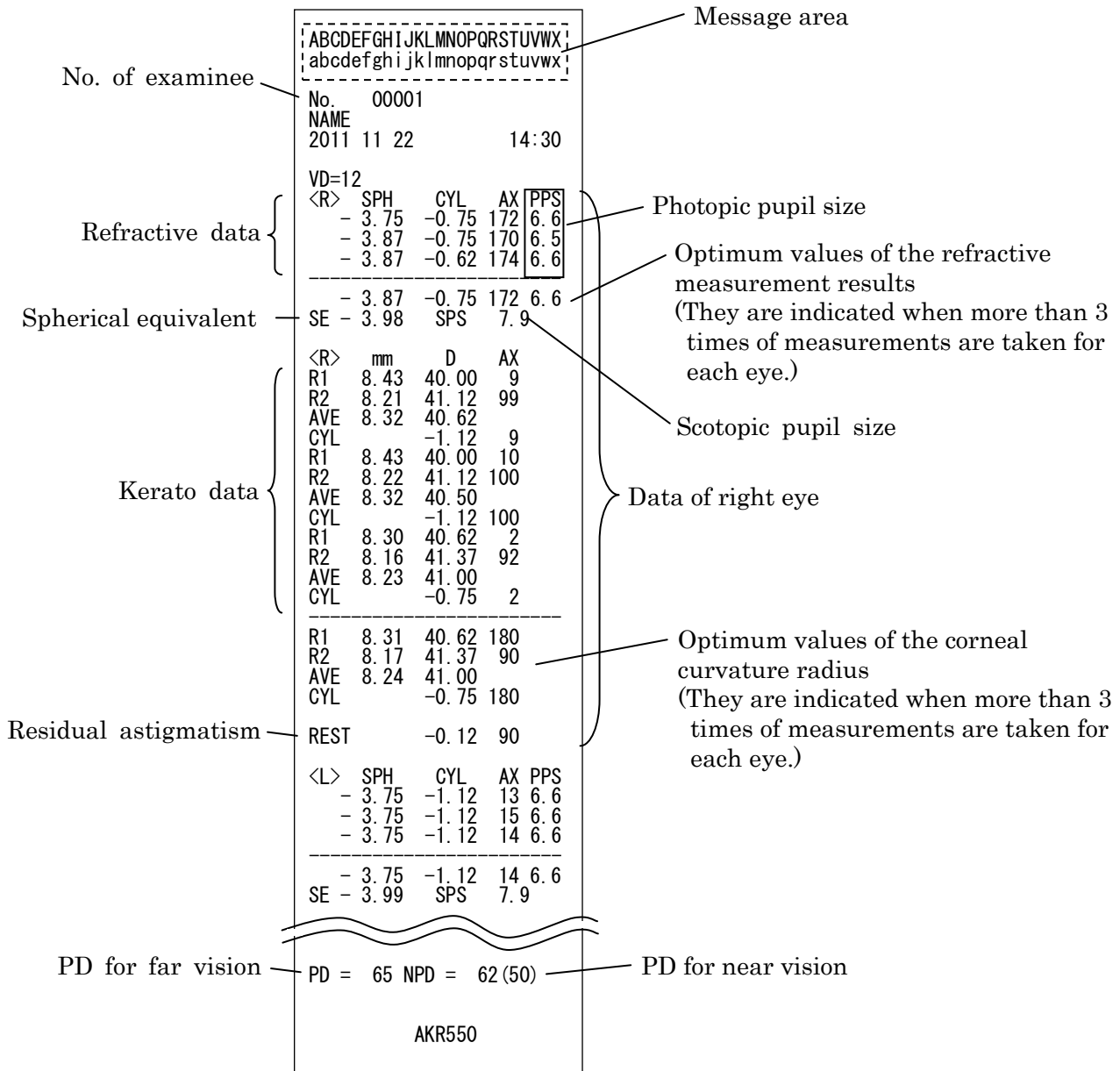

※Message area

It can print out the registered characters in the range of 24 characters/line × 2 lines in the message area. Refer to the “Message” section of “4.4 Setting of Setup Screen” about registration of the characters.

4.4 Setting of Setup Screen

The standard measurement mode is preset to be ready for use. However, altering the setting can be done easily if necessary.

Press **Setup** switch under the LCD monitor and display the setup screen.

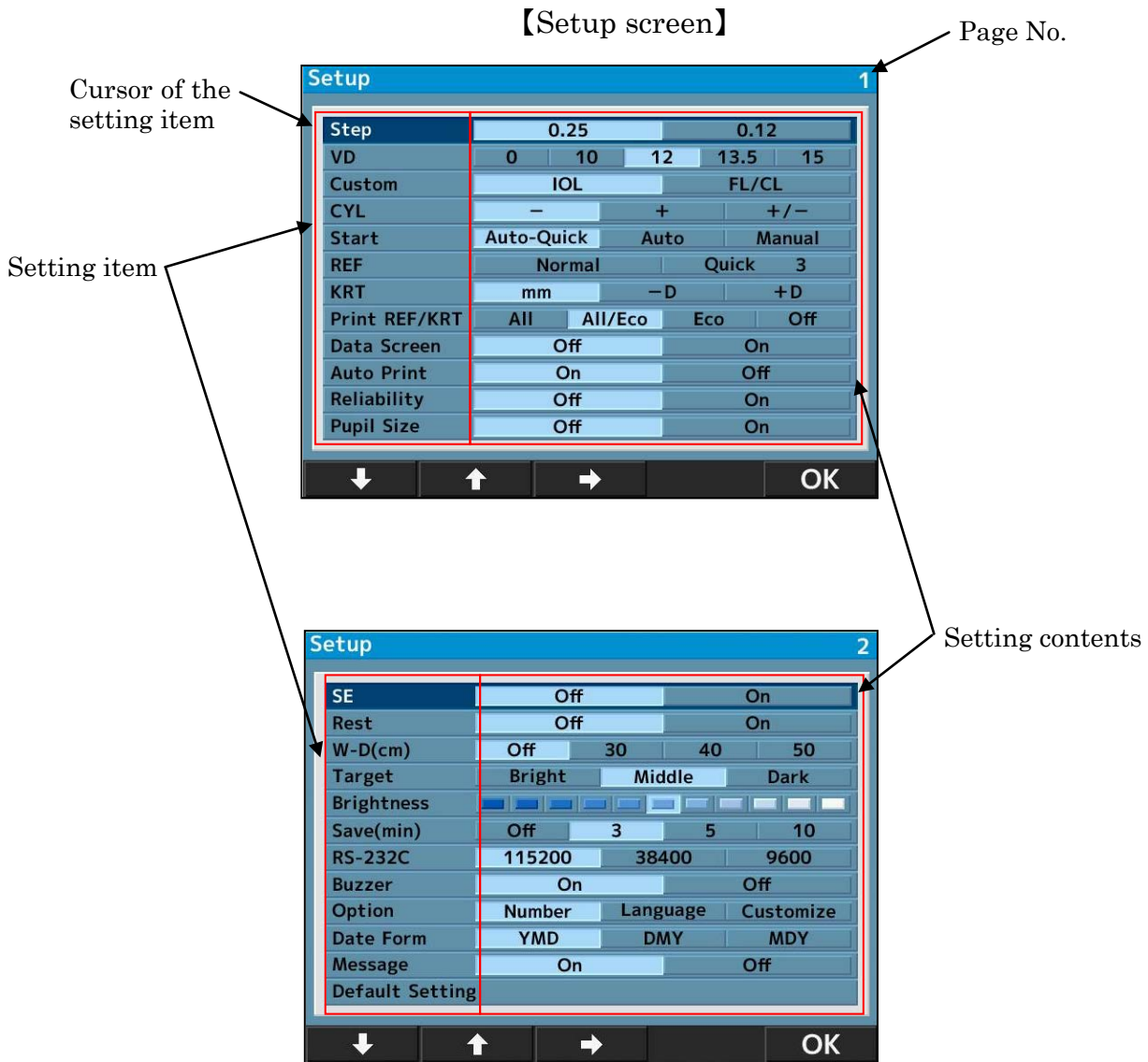

There are 24 setting items on the menu screen.

Select the item to be changed by pressing **↓** or **↑** and change it by pressing **→**. After changing it, return to the measurement screen by pressing **OK**.

Details of Each Setting Item

[Screen 1]

- Step Select the step for refractive measurement.
- VD Select the corneal vertex distance.
- IOL Select the function of the operation switch.
 - IOL : Switch to the mode to measure IOL.
 - FL/CL : Switch the corneal vertex distance (frame value/ contact value)
- CYL Select the sign of cylindrical value.
- Start Select the measurement start method.
 - Auto-Quick:
It starts measurement when the alignment is achieved. Take 1 time of Kerato measurement and 3 times of refractive measurements continuously for each eye. The result is printed out automatically when “Auto Print” is set as ON. (For the refractive measurement, only one time of the fog control is done at the beginning.)
 - Auto:
Take 3 times of Kerato measurements and refractive measurements continuously for each eye. The result is printed out automatically when “Auto Print” is set as ON. (For the refractive measurement, the fog control is done every time.)
 - Manual:
Measurements are taken every time the measurement switch is pressed.
- REF Select the refractive measurement method. The setting is valid only when the measurement start method is set as Manual.
 - Normal:
A measurement is taken one time by pressing the measurement start switch.
 - Quick:
Continuous measurement is started as much as it is set by pressing the measurement start switch one time. (Maximum of 10 times.) (For the refractive measurement, only one time of the fog control is done at the beginning.)
- KRT Select the sign of Kerato measurement result.
 - mm : Corneal Curvature radius
 - -D : corneal astigmatism (-)
 - +D : corneal astigmatism (+)
- Print Select the format of print-out.
 - REF/KRT
 - All :
Print out all of the measurement data. (Maximum of 10 times for each eye.)
 - All/Eco:
Print out all of the REF measurement. (Maximum of 10 times for each eye.)
Print out only the optimum values for the Kerato measurement.
 - Eco: Print out only the optimum values.
 - Off : No measurement result is printed out.

- Data Screen Display the stored measurement results.

 - On : Display the measurement results on the screen.
 - Off : Display no measurement result on the screen.

- Auto Print Select the print-out method. This function is valid only when the setting of Start is either Auto-Quick or Auto.

 - On : Activate the auto print function.
 - Off : Invalidate the auto print function.

- Reliability Select if displaying the low reliability mark on the measurement values or not.

 - On: If it is judged that the measurement value possesses low reliability, display the low reliability mark “*” on it.
 - Off: No low reliability mark is displayed.

- Pupil Size Set the function of the photopic pupil diameter measurement.

 - On : Take a measurement of the photopic pupil diameter when taking a refractive measurement.
 - Off : Photopic pupil diameter is not measured.

【Screen 2】

- SE Set the output of SE value

 - On : Output the representative value of SE on print-out, data screen and communication output (XML format only)
 - Off : No output of SE value

- Rest Select the output of residual astigmatism.

 - On : Display the residual astigmatism.
 - Off : No astigmatism is displayed.

- W-D(cm) Set the work distance.
The near pupil distance is automatically computed after the measurement and displayed on the screen.

- Target Select the brightness of the target.

 - Bright : Brighten the target
 - Middle : Normal setting
 - Dark : Darken the target

- Brightness Adjust/ change the brightness of the LCD monitor.

- Save(min) Select the switchover time to activate the power saving function (unit is min.).

- RS-232C Select the baud rate when sending the measurement data to the exterior computer.

- Buzzer Set if activating the buzzer at the time of switching to the power saving function or not.

 - On : Buzzer is on.
 - Off : Buzzer is off.

- Option It is switched to each option screen when selecting the item to be set on the option of the setup screen.





【The screen of each option and the details】

1. Number

This function can set or change the number of the examinee, and select if displaying the number on the monitor and the printout.

Set/change the number of the examinee. (Maximum of 5 digits can be input.)	
Select if printing out the number of the examinee or not. •Off : The number is not printed out. •On : The number is printed out.	
Select if displaying the number of the examinee on the screen or not. •Off : The number is not displayed. •On : The number is displayed.	

	Reset of the number of the examinee If moving the cursor to “Reset” on “Set”, the “+” switch on the bottom is changed to “Reset”. So, press the “Reset” switch to reset the number.
---	---

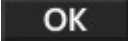
- (1) Move the cursor to the item to be set or changed by pressing  or  and change it by pressing  or .
- (2) Go back to the setup screen by pressing  after the setting or the change.

2. Language

This function can select the language displayed on the screen.

Selectable language: EN (English), CN (Chinese), FR (French), ES (Spanish), PT (Portuguese), IT (Italian), DE (German)

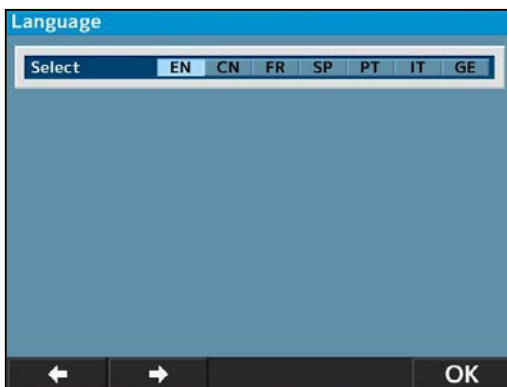

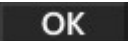
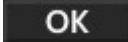
- (1) Move the cursor to the item to be set by pressing  and execute it by pressing .
- (2) Go back to the setup screen by pressing  after finishing the setting.

3. Customize

- Reset Screen

This function can delete the measurement values on the screen after printout.

On : Delete the measurement values on the screen after printout.

Off : Leave the measurement values on the screen after printout.

- Output

This function can select the output procedure of the measurement data

- A : Standard

- B : Output data common spec. of ophthalmic testing device

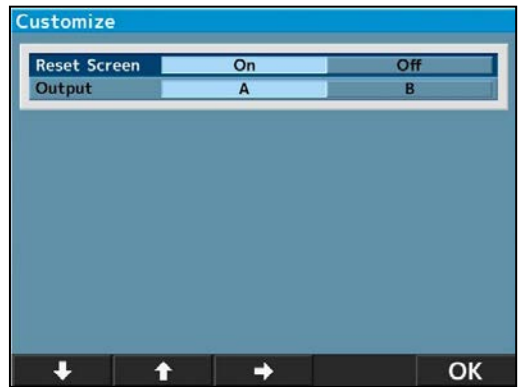

- Date Form

Select the display format of the date from the followings.

YMD : Display the date as year/ month/day.

DMY : Display the date as day/month/year.

MDY : Display the date as month/day/year.



The screen on the left appears when selecting “YMD” and pressing **Enter** .

(1) Move the cursor to the item to be changed by pressing **↓** or **→** and input the date by pressing **+** or **-** .

(2) Go back to the setup screen by pressing **OK** after finishing the setting.

- Message

This function is to input the message in the range of 24 characters/line × 2 lines and output it.



The message input screen on the left appears by selecting “On” and pressing **Enter** .

(1) Select the characters by pressing **←** or **→** and input them by pressing **Set** .

A space can be input by pressing **>** .

(2) Go back to the setup screen by pressing **OK** after finishing the setting.

- Default Setting

Reset the settings to the factory setting.

4.5 Scotopic Pupil Size (SPS) Measurement Function

This function is to measure the pupil size of the subject eye in the dark.

Switch to the SPS measurement by pressing the measurement mode switch on the front panel. When measuring the scotopic pupil size, darken the room.

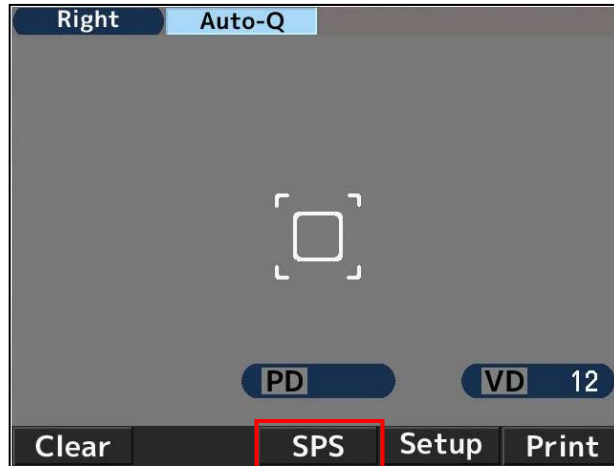

Indication of SPS measurement mode



<To print out the measurement results of SPS, R/K, REF and KRT at the same time>

The measurement results of SPS, R/K, REF and KRT can be printed out at the same time by pressing the print button after the measurement of SPS when switching to SPS measurement mode without printing out their measurement result with the setting of Auto Print "Off".

```

NAME
2011 11 22      14:30

VD=12
<R>
SPS  7.3

<L>
SPS  7.5

PD =  63

      AKR550
    
```

【Example of printout】

```

          *** REF ***
R) SPS 7.3 mm      L) SPS 7.5 mm
   PD = 63
    
```

【Example of data screen output】

4.6 IOL Measurement Function

When measuring the IOL (intraocular lens) implanted eye, the eye with a cataract, or the eye with the scratches on the cornea, the measurement errors may occur and it is difficult to complete the measurement with REF measurement.

In this case, it is easier to measure if moving the device closer to the examinee. Also these can be measured with IOL mode.

- 1) Activate the IOL function by pressing the IOL switch on the front panel of the main unit and switch to the IOL measurement mode.
At this time, the icon of the IOL measurement mode is indicated on the top of the monitor.
- 2) Catch the subject eye on the monitor by operating the joystick. As bringing the subject eye into focus, the Kerato ring, the alignment mark “+” and the focus indicator appear.
- 3) Operate the joystick by following the guidance of the focus indicator and move the main unit to bring the subject eye into focus.
- 4) It is in focus when the focus indicator turns to green. When it turns to green, take a measurement by pressing the measurement switch.

Indication of IOL measurement mode

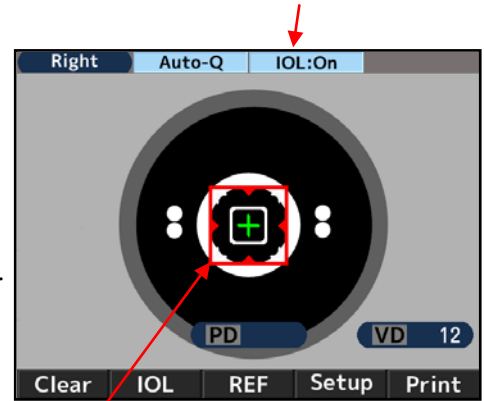

Focus indicator



Measurement is started automatically when the setting of Start is either Auto-Quick or Auto.

NAME				
2011 11 22	14:30			
VD=12				
<R>	SPH	CYL	AX	PPS
I	- 2.50	-2.00	177	5.4
I	- 2.50	-2.00	175	5.4
I	- 2.50	-2.00	177	5.4

	- 2.50	-2.00	177	5.4

【Example of printout】

R)	SPH	CYL	AX	PPS	RIGHT
I	- 2.50	-2.00	177	5.4	
I	- 2.50	-2.00	175	5.4	
I	- 2.50	-2.00	177	5.4	

	- 2.50	-2.00	177	5.4	

【Example of data screen output】



“T” is indicated on the left of the measurement value when measuring it in the IOL measurement mode.

The IOL measurement mode is canceled by performing one of the followings:

- ① Pressing the IOL switch one more time,
- ② Switching the measurement mode,
- ③ Pressing the print switch,
- ④ Turning off the power.

【When the measurement cannot be completed because of the errors with IOL mode】

There is a possibility that the measurement of the IOL (intraocular lens) implanted eye cannot be completed because of the implanted IOL.

In this case, move the device closer to the examinee with keeping the alignment in-focus. It might help curbing the influence and the measurement can be done.



The image of the eyeground is displayed by holding IOL or FL/CL switch for seconds.

4.7 Low Reliability Mark Display Function

This device has the low reliability mark display function. The low reliability mark is displayed on the measurement result which reliability is low when taking the refractive measurement with this function activated. Consider the refractive measurement value with the low reliability mark as reference.

NAME				
2011 11 22			14:30	
VD=12				
<R>	SPH	CYL	AX	PPS
*	- 2.50	-2.00	177	5.4
*	- 2.50	-2.00	175	5.4
*	- 2.50	-2.00	177	5.4

	- 2.50	-2.00	177	5.4

【Example of printout】

R)	SPH	CYL	AX	PPS	*** RIGHT ***
*	- 2.50	-2.00	177	5.4	
*	- 2.50	-2.00	175	5.4	
*	- 2.50	-2.00	177	5.4	

	- 2.50	-2.00	177	5.4	

→ OK Print

【Example of data screen output】

4.8 Output

This device is connected to PC etc. by RS-232C.

Refractometer

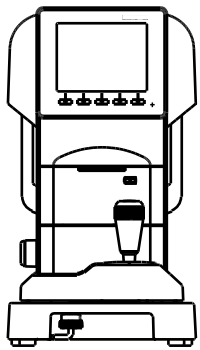

D-Sub9pin
Male

D-Sub9pin
Female



Connect with a straight cable

PC

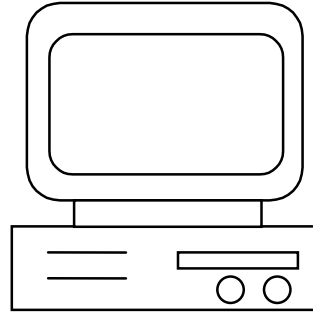

【Connecting Diagram: RS-232C】

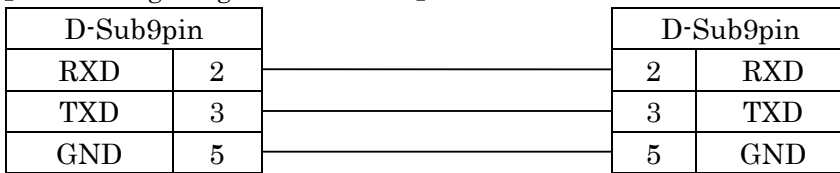

Use the shielded wire for the connection cable to protect the output data from noise.

※ Contact your local distributor about operation, connection method and output data etc.



The instruments which are connected to this device by RS-232C should comply with the safety standard of IEC60601-1 or IEC60950.

Select the baud rate of RS-232C from below.

Selectable baud rate	Setting before shipment
115200bps	○
38400bps	
9600bps	



In case of RS-232C, CHARACTER (data bit count), PARITY (check of transfer data) and STOP BIT (exit code) are set as CHARACTER (8), PARITY (NONE) and STOP BIT (1) and cannot be changed.

4.10 Power Saving Function

The power saving function is activated when leaving it on without any switch operations.
(Refer to “Save (min.)” of “4.4 Setting of Setup Screen” about the selection of the power saving function.)

The measurement mode is activated by pressing the switch (the switch on the front panel of the measurement start switch).

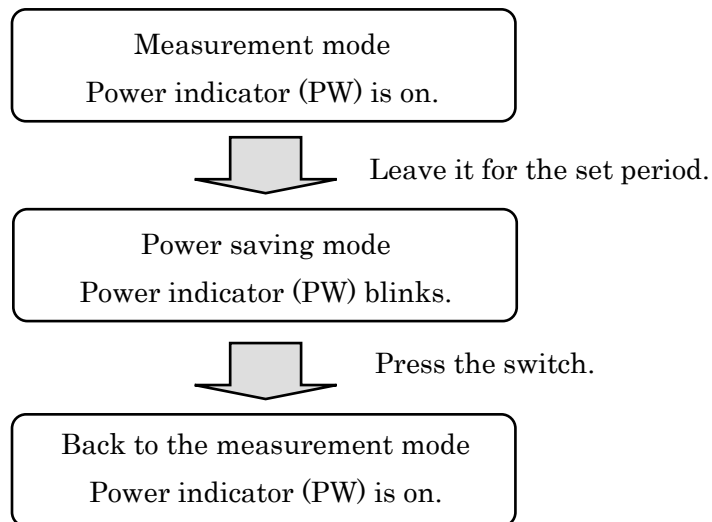

4.11 Contact Lens: Measurement of Base Curve

This device can measure the base curve of the hard contact lens.

The lens can be measured by placing it onto the contact lens holder of the model eye shown as below.

- (1) Put a small amount of water on the concave side of the contact lens holder.
- (2) Place the contact lens so that its convex side faces the holder.

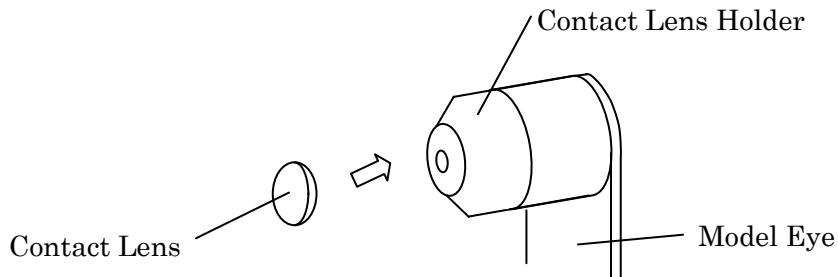

- (3) Confirm that the contact lens is firmly adhered to the holder with water and does not slip down. Then, take a measurement by setting the model eye unit on the main unit.

5. Storage and Maintenance

5.1 Reload of Printer Paper

- 1) Push on the printer door button to open the printer paper cover.

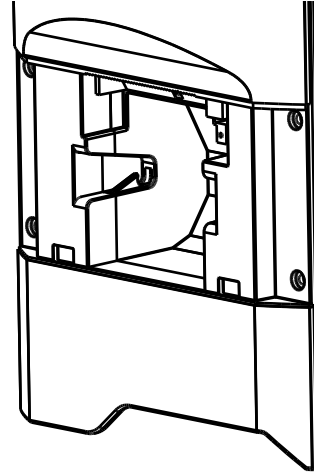
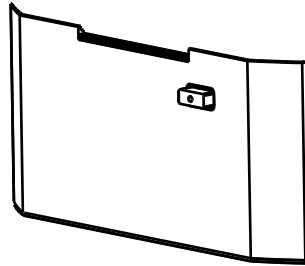

- 2) Pay attention to the direction of the paper rolled and set it in.
Note) Set the paper as coming out toward the front from the upside.

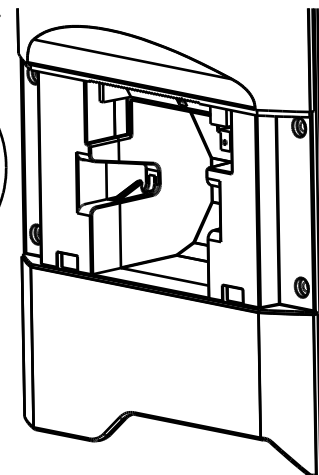
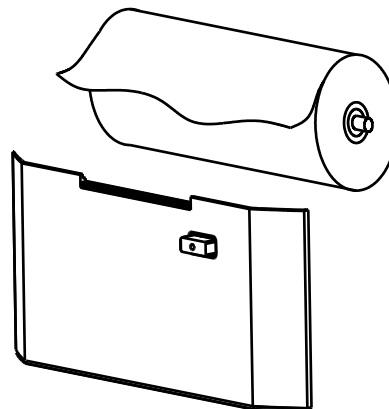

- 3) Close the printer cover until it clicks. If the cover is not closed completely, the error message appears and cannot print out.

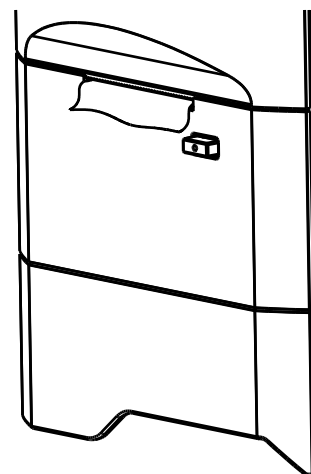

5.2 Fuse Replacement



Warning

Unplug the power cord from the unit before removing the fuse holder. You may be in danger of electric shock if removing the fuse holder without unplugging the power cord.

When a fuse is blown, remove the fuse holder from the device for replacement. Remove it by pushing the fuse holder and rotating it in counterclockwise direction.



Always use the specified fuse (T2A L 250V).

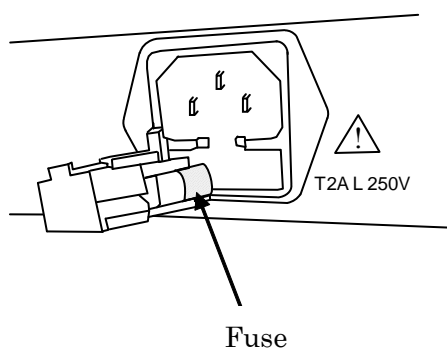

5.3 Setting of Chinrest Liner

Set the chinrest liners onto the chinrest and secure them with the chinrest pins (refer to the diagram on the right).



For sanitary reasons, dispose the top chinrest liner after every patient.

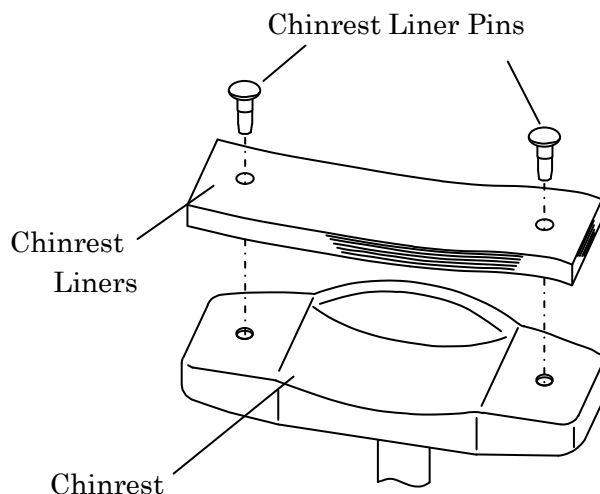

- Comply strictly with above about the chinrest liners.
- For sanitary reasons, disinfect the chinrest with the ethanol for disinfection.
 - ※ Ethanol for disinfection contains 76.9 to 81.4vol% of ethanol (C₂H₆O) at 15°C (specific gravity).

5.4 Storage of Device

(1) Points to check for long-term storage

- Turn off the power.
- Remove the power cord from the outlet.
- Place the main unit undermost.
- Secure the main unit by locking the slide lock of the main unit.
- Put the dust cover on the main unit.

(2) Notes about the storage environment

Avoid storage under the following conditions

- Where dust accumulates
- Where water may get on the unit
- Where temperature and humidity are high
- Where sunlight directly contacts
- Unstable and high place

Always follow the environment conditions for storage below.

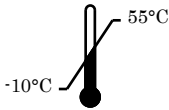
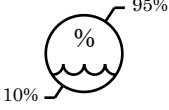
Environmental Conditions for Storage	
	



Check the items above in case that the device is not used or is stored for a long time. If you use the device after long-term storage, operate it according to the instructions of “4.3.1 Preparation for Measurement”.

5.5 Confirmation of Measurement Accuracy

It is extremely important to check operation and accuracy of the device with the supplied model eye. We recommend checking its accuracy periodically.

If the measurement result of the model eye is within the tolerance listed below, the measurement is considered as reliable and accurate. If the result exceeds the tolerance, contact your dealer immediately.

Model Eye Data		
SPH	CYL	R
Indicated value ± 0.25	0 ± 0.25	Indicated value ± 0.03

※ The precise value of the supplied model eye is indicated on the model eye stand (VD=12).

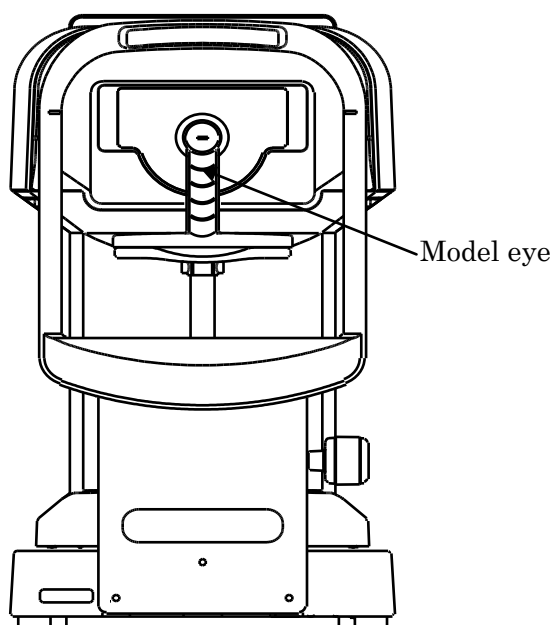

Setting of model eye

NOTE

- Remove the contact lens holder and set the model eye carefully not to incline back and forth and around.
It cannot take CYL value data correctly if the model eye is inclined.
- Set the model eye at the position where an alignment mark is located at the center of the reticle mark and the model eye comes into focus.
- When all of the conditions above are met, start the measurement.

5.6 Periodical Inspection and Maintenance

To prevent malfunction and accidents and maintain to performance and reliability of the product, it is recommended to request your distributor for the periodical inspection and maintenance once a year. The periodical inspection and maintenance include inspection of the function and performance of the product, and cleaning, adjustment and replacement of consumable parts if necessary.

It is recommended for the distributors to perform the cleaning of each part, performance check and accuracy check at least once in a year.

Cleaning of each part : exterior parts and optical system

Performance check : main unit and each switch

Accuracy check : measurement function of refractive power and corneal curvature radius

6. Tip for Effective Measurement

- (1) Do not allow external light to directly penetrate the room.
- (2) Fluctuation of the measurement values may occur if the examinee looks something other than the target. Urge the examinee to concentrate on the target set in front.
- (3) Talk to the examinee in a relaxed and friendly manner, so as to allay any fear or doubt they may have.
- (4) Inappropriate height of the chinrest or the chair will cause the examinee fatigue. Adjust the (optional) instrumental table to establish the most comfortable and convenient position for the examinee.
- (5) When the eyelash or eyelid interfere measurement, an error will occur in the measurement. Urge the examinee to keep his/her eye open wider.
- (6) Tear residue or eye mucus, etc. trapped on the corneal surface may cause measurement errors. Check the surface with the LCD monitor, and if you see something moving when the examinee blinks, remove it before measurement.
- (7) When the pupil of the target eye is smaller than the minimum measurable pupil diameter, it cannot take a measurement correctly.
If it is difficult to take a measurement because the pupil is too small, darken the surroundings (room) or the target to allow the pupil to dilate as much as possible.
- (8) If the examinee moves his/her head during the measurement, AXIS value will be adversely affected. Ask him/her to maintain a correct posture.

7. Error Display

This device automatically evaluates measurement condition or result and indicates error messages if it is invalid. An error messages also appear when abnormality is detected in its operational system. When any error messages appear, always check the system with a supplied model eye. If it appears when no abnormality in system is detected, check the measured eye for eye diseases or problems.

Message	Cause	Corrective Action
RETRY	Failed to capture eye image because the examinee blinks or moves during measurement or the examined eye has eye diseases.	Try alignment precisely and conduct measurement again. Consult your dealer immediately if the message appears again. Do not try to repair it by yourself.
SPH OVER	Exceeded spherical measurement range (-25 to +25D). (In case of VD=0, contact value)	
CYL OVER	Exceeded cylindrical measurement range (0 to ±10D) (In case of VD=0, contact value)	
ERR	Exceeded measurement value of pupil diameter (2.0 to 8.5mm)	
Target motor fault	Detected abnormality in motor control system	Turn off the power and turn it back on. Consult your dealer immediately if the message appears again. Do not try to repair it by yourself.
Focus motor fault		
EEPROM fault	Failure of initialization	
Printer overheated	Printer head is overheated.	Turn off the power and turn it back on. Consult your dealer immediately if the message appears again. Do not try to repair it by yourself.
Printer cover opened	Printer cover is opened.	Close the printer cover properly. Turn off the power and turn it back on. Consult your dealer immediately if the message appears even after closing the cover.
Paper Empty.	No printer paper.	Set the printer paper. Refer to “5.1 Reload of Printer Paper”.

8. Main Troubles and Troubleshooting

If a malfunction is found, refer to the table below to take the appropriate measures.

 Warning	Never disassemble, modify or repair the device. It can result in electrical shock.
--	---

Symptoms	Causes and Measures
The monitor and the power indicator are not turned on.	<ul style="list-style-type: none"> • The power cord may not be properly connected. Make sure to connect it securely. • The fuse may be blown. If so, replace it with the new one.
The fuse is blown when the power switch is turned on.	<ul style="list-style-type: none"> • Contact your local distributor immediately.
The monitor display is suddenly disappeared.	<ul style="list-style-type: none"> • The saving function may be activated. Press any switch to deactivate the saving function.
The moving parts such as a joystick are not moving appropriately.	<ul style="list-style-type: none"> • Do not move the part forcibly. Contact your local distributor or service person.
It does not print out.	<ul style="list-style-type: none"> • Check if the papers are set. Reload them if the papers are not set. • The setting of Print REF/KRT may be set as OFF. Change the setting.
The printer paper comes out but not printing.	<ul style="list-style-type: none"> • The printer paper may be set in a wrong direction. Set the paper properly.
The date setting is inaccurate.	<ul style="list-style-type: none"> • The battery in the device may be run out. Keep the power on for 24 hours and recharge it.

Contact your local distributor immediately if the situation does not improve even after taking the measures mentioned above.

9. Specifications

Refractive measurement range	Sphere (S)	-30D to +22D	(In case of VD=12) (Step: 0.12/0.25D)
	Cylinder (C)	0 to ±10D	(Step: 0.12/0.25D)
	Axis angle (A)	1 to 180°	(Step: 1°)
Corneal curvature radius measurement	Radius of curvature	5.0 to 10.0mm	(Step: 0.01mm)
	Corneal power	33.75 to 67.5D	(Corneal refractive n=1.3375) (Step: 0.12/0.25D)
	Degree of corneal astigmatism	0 to ±10D	(Step: 0.12/0.25D)
	Axis angle	1 to 180°	(Step: 1°)
Pupil diameter measurement	Measurement range	φ2.0 to 8.5mm	(Step: 0.1mm)
PD measurement	Measurement range	85mm	(Step: 1mm)
Vertex distance	0, 10, 12, 13.5, 15mm		
Minimum pupil diameter	φ2.0 mm		
Measurement time	Refractive measurement	Approx. 0.07 sec.	
	Corneal curvature radius	Approx. 0.07 sec.	
Printer	Thermal line printer (Paper width: 58mm)		
Internal monitor	5.7 inches color LCD monitor		
Shifting range of the measurement unit	Back/forth ±22mm	Right/left ±43mm	Up/down ±17 mm
Vertical adjustment range of the chinrest	±30mm		
Dimensions	(W) 240mm	(D) 422mm	(H) 430mm
Weight	Approx. 13kg		
Output	RS-232C		
Power source	100 to 240V 50/60Hz		
Consumption	60VA		
Power saving function	OFF, 3, 5, 10 min. (switchable)		



The circuit diagram, parts lists, and description and instructions for calibration and testing are available separated from this manual.



Essilor International

147 rue de Paris
94220 Charenton le Pont
FRANCE