

# CP 550



## USER MANUAL

# CONTENTS

<b>I. INTRODUCTION</b>	<b>4</b>
<b>II. SUPPLY PACKAGE</b>	<b>6</b>
1. Unpacking and storage	7
2. List of accessories	7
a. Standard accessories	7
b. Optional accessories	7
<b>III. GENERAL DESCRIPTION</b>	<b>8</b>
1. Intended use	9
a. Intended purpose	9
b. Indications for use	9
c. Expected clinical benefit	9
d. Intended population	9
e. Intended users	9
2. Device description	9
a. Front view	9
b. Rear view	9
c. Remote	10
<b>IV. INSTALLATION / CONNECTION</b>	<b>11</b>
1. Installation of the device	12
a. Projector installation	12
b. Electrical power supply	12
c. Remote control	12
d. Screen set-up	12
e. Projection focusing	12
f. Brightness setting	13
2. Turning ON/OFF	13
3. Connection to other instruments	13
<b>V. USE OF THE DEVICE</b>	<b>14</b>
1. General uses	15
2. List of tests	15
3. Program mode	16
a. Recording a program	16
b. Special manipulation	17
c. Working in [Program] mode	17
<b>VI. ERROR DISPLAY</b>	<b>18</b>
<b>VII. SAFETY CONSIDERATION</b>	<b>20</b>
1. Symbols	21
a. On the document	21
b. On the device and packaging	21
2. Precautions for use	22
3. Contraindication	22
4. Side effects	22
5. Exclusion of liability clause	22
6. Power Source	22
7. Precautions regarding IT Network	22

8. Electromagnetic compatibility	23
a. Magnetic and electromagnetic immunity	23
b. Radiofrequency wireless communications	24
<b>VIII. TROUBLESHOOTING</b>	<b>26</b>
<b>IX. MAINTENANCE</b>	<b>28</b>
1. Storage and handling condition	29
2. Cleaning	29
3. Periodical inspection and maintenance	29
4. Disassembly of the product and transport	29
a. Replacing a fuse	29
b. Replacing batteries on the remote control	29
5. Disposal	30
<b>X. SPECIFICATIONS</b>	<b>31</b>
1. Technical data	32
a. Projector	32
b. Remote control	32
2. Connectivity to other devices	32
3. It requirements	32
<b>XI. QR CODE</b>	<b>33</b>

# I. INTRODUCTION



 The latest version of this user manual is available on a web space.  
To access other available languages, please scan the QR code available at the end of this user manual > QR Code Chapter (p.33).

For a safer, more effective use, follow the instructions outlined in this manual.

 Please note that the term CP550 is used for designating CP550EA and CP550EB.

Copyright © 2023 Essilor - Original manual - All rights reserved.

All reproduction of the content of this document, whether in part or as a whole, for the purpose of its publication or dissemination by any means and in any format whatsoever, even free of charge, is strictly prohibited without Essilor's prior written consent.

## II. SUPPLY PACKAGE

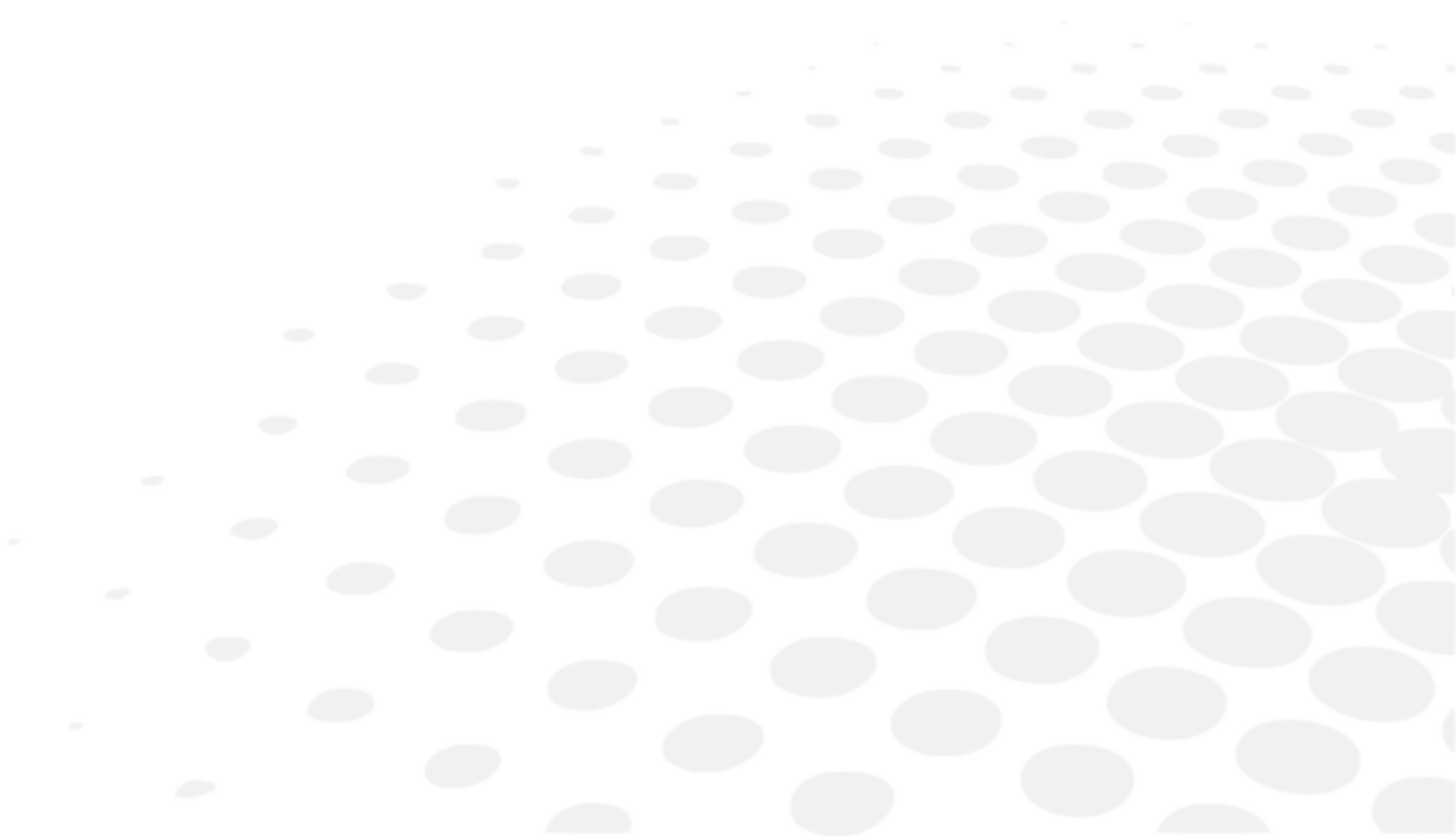

## 1. Unpacking and storage

This section is not applicable.

## 2. List of accessories

While unpacking, check that the following standard accessories are included.

### **a. Standard accessories**

---

- Projector (x1)
- Screen (x1)
- Power supply cable (x1)
- Calibration sheet (x1)
- Test card (x1)
- Protective cover (x1)
- Fuse (250V, 2AT) (x2)
- Remote control (x1)
- Alkaline battery LR03 (x4)
- Hex head key (5 mm) (x1)
- Stand

### **b. Optional accessories**

---

- Wall mounting assembly
- Projector arm (without rotation)
- Projector arm (with rotation)
- Polarized filter
- Red-green peephole

### **III. GENERAL DESCRIPTION**



## 1. Intended use

This section is not applicable.

### a. Intended purpose

This section is not applicable.

### b. Indications for use

This section is not applicable.

### c. Expected clinical benefit

This section is not applicable.

### d. Intended population

This section is not applicable.

### e. Intended users

This device is intended for eye care professionals use only.

## 2. Device description

### a. Front view

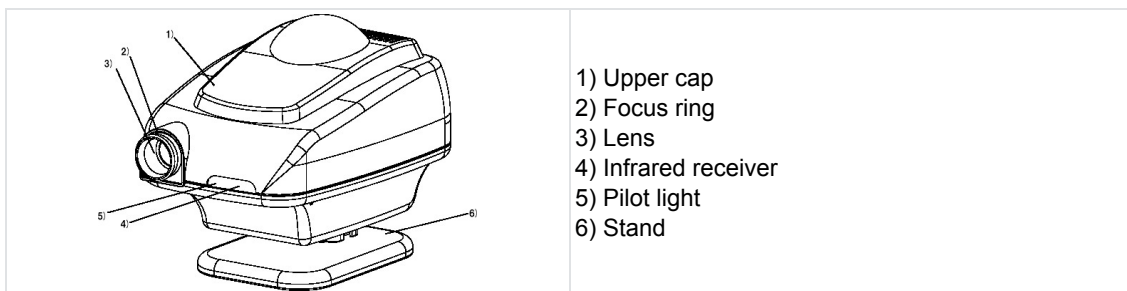

### b. Rear view

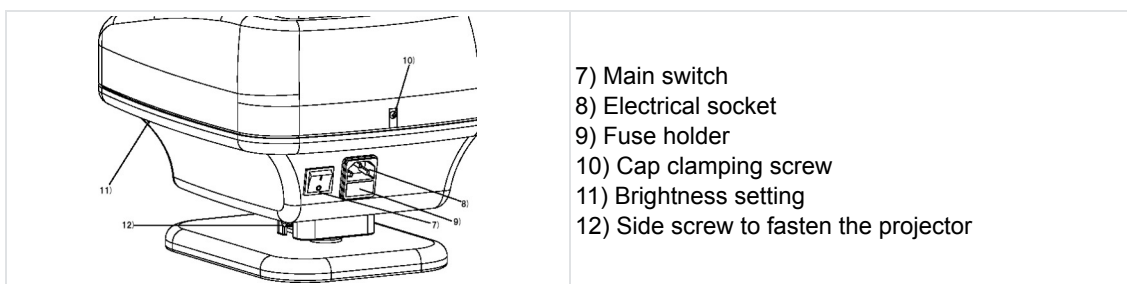

**c. Remote**

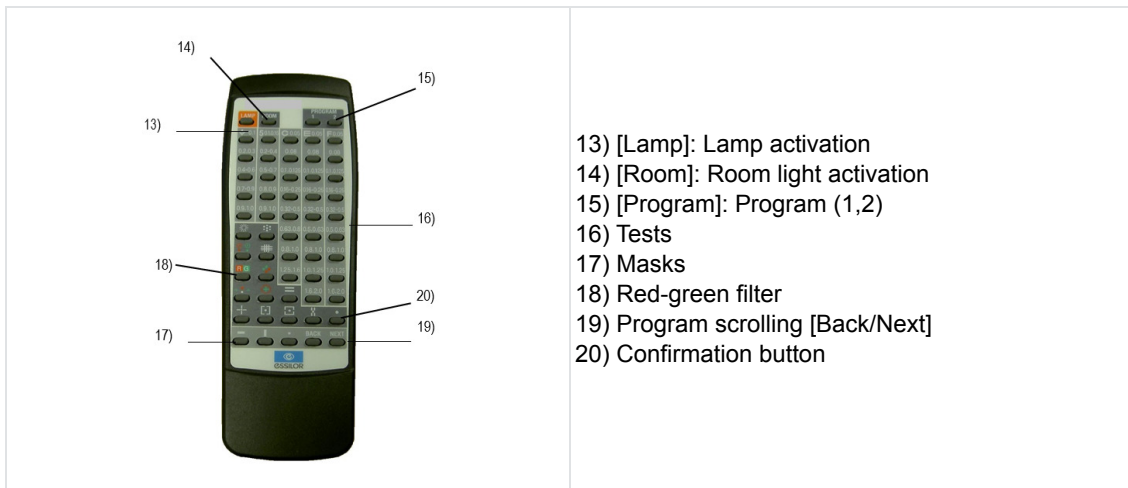

## **IV. INSTALLATION / CONNECTION**

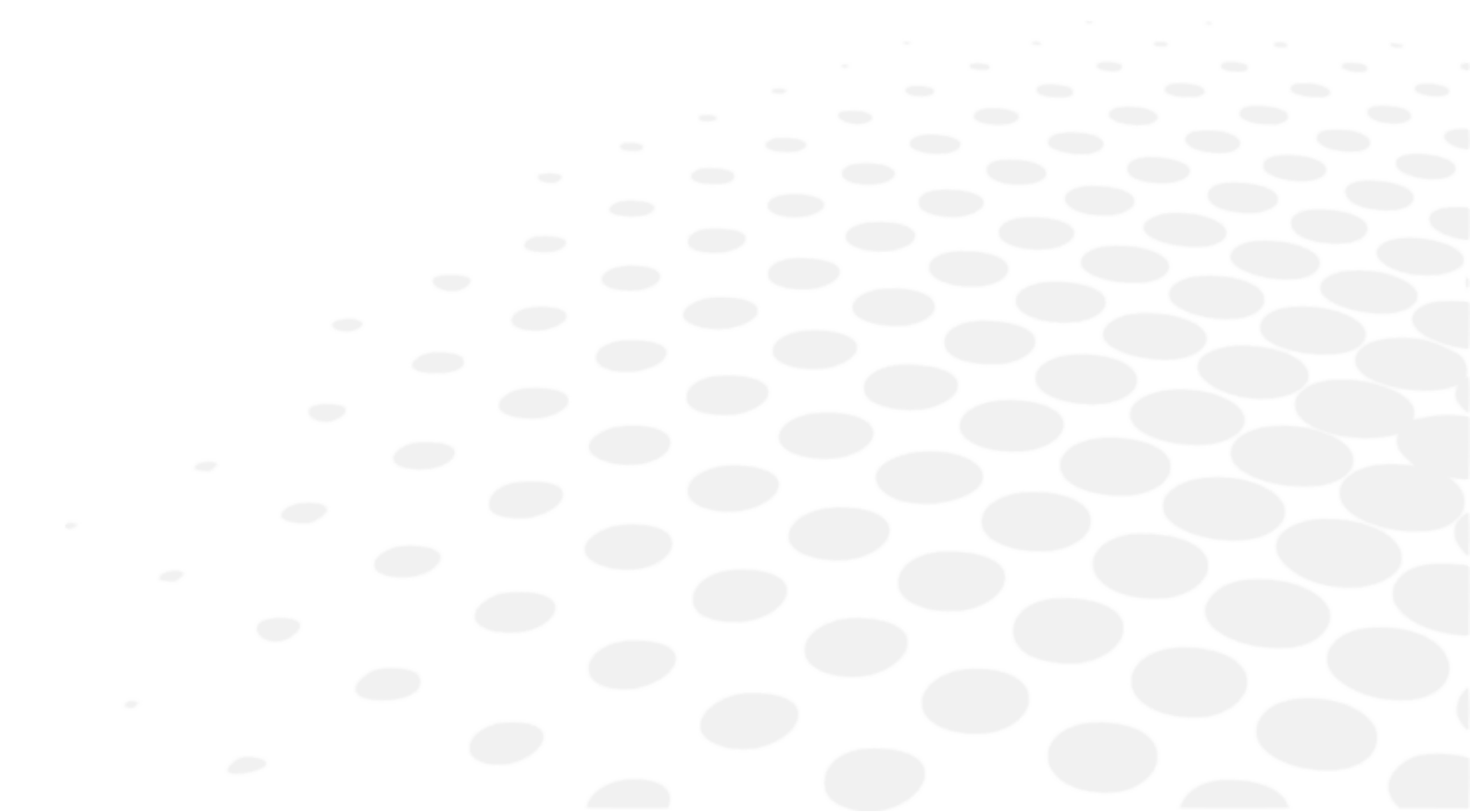

## 1. Installation of the device



- When your CP550 is not in use, be sure to protect it with the cover provided.
- Always prevent condensation from forming.
- When using or storing the device, place it in a safe and stable location. Avoid places that are exposed to dust, gas, salt or sulfur.
- Do not set up the CP550 near any explosive or flammable substance.
- Protect the device from all vibrations and shocks.
- Whenever moving the projector, be sure to protect it from shocks by using the original packaging.
- Never place flammable objects on top of the CP550, as fire could break out.
- Before discarding the product packaging, sort the various materials and proceed in compliance with national or local legislation.
- Do not touch any of the optical parts due to the risk of irreversibly impairing calibration accuracy.
- Insert the power supply plug into both the socket and device tightly. The projector must, without exception, be connected to an electrical power network with a ground.
- When moving the CP550, first turn off the power switch then unplug the electrical cable.
- When turning the projector lamp on, never look through the projector lens.

### a. Projector installation

Fasten the projector connector to the ball joint on the stand as indicated, then tighten the side screw (12) using the hex head key. If the connector has not been appropriately fastened, the projector could suddenly swivel and cause injury.

### b. Electrical power supply

Connect the power supply cable to the electrical socket (8) and then to the wall outlet (AC).

### c. Remote control

Remove the cap from the battery compartment of the remote control unit. Load two SUM4 batteries in respecting the [+] and [-] markings.

### d. Screen set-up

Insert the cable supplied with the device into the two ports located on top of the screen, then tie the two ends. Fasten a hook into the wall at the height of the patient's point of observation, then hang the screen horizontally. The presentation distance must lie between 2 and 7 meters.



- If you are not using the standard screen included with the projector, you will not be able to obtain the same performance as with the original diagnostic equipment.
- The projection must be made on the smooth and shiny side.

### e. Projection focusing



The projector and patient must be positioned the same distance from the screen.

When changing projection distance, the size of the vision test types (or optotypes) automatically varies to ensure constant compliance with optotype presentation standards.

- 1 Turn the main switch (7) on.
- 2 Press the 0.1 test button (Landolt or Snellen) on the remote control.
- 3 Loosen the side screw (12) during calibration and then adjust the projector angle such that the test is positioned in the middle of the screen
- 4 Turn the focus ring (2) in order to complete focusing on the 0.1 test by use of the calibration sheet provided with the projector. Move the CP550 either forwards or backwards so that the test size is identical to the size of the calibration sheet.

## f. Brightness setting

- 1 Turn the main switch (7) on.
- 2 Insert a narrow screwdriver (length: 6 cm or more) into the brightness setting port (11) to press the button.
  - > A signal then sounds 3 times.
  - > The orange diode lights up and Landolt's 0.05 test is displayed.
- 3 Press either the [Back] or [Next] button on the remote control to adjust brightness.
  - 
    - o Initial setting: 200~250 Cd/m<sup>2</sup> (5 m).
    - o Possible setting according to the ISO standard: 80 ~ 320 Cd/m<sup>2</sup>.
- 4 Press the Lamp button (13).
  - > The signal again sounds three times.
  - > The brightness setting is now memorized by the machine.

## 2. Turning ON/OFF

- 1 Press on the ON/OFF switch (main switch at the rear of the device).

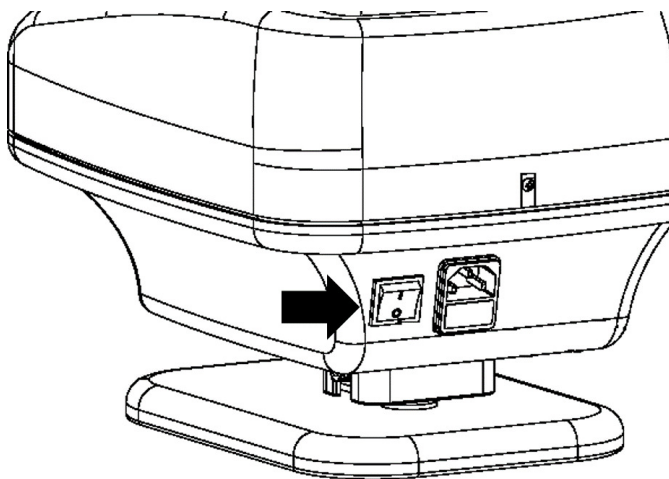

## 3. Connection to other instruments

This section is not applicable.

## **V. USE OF THE DEVICE**

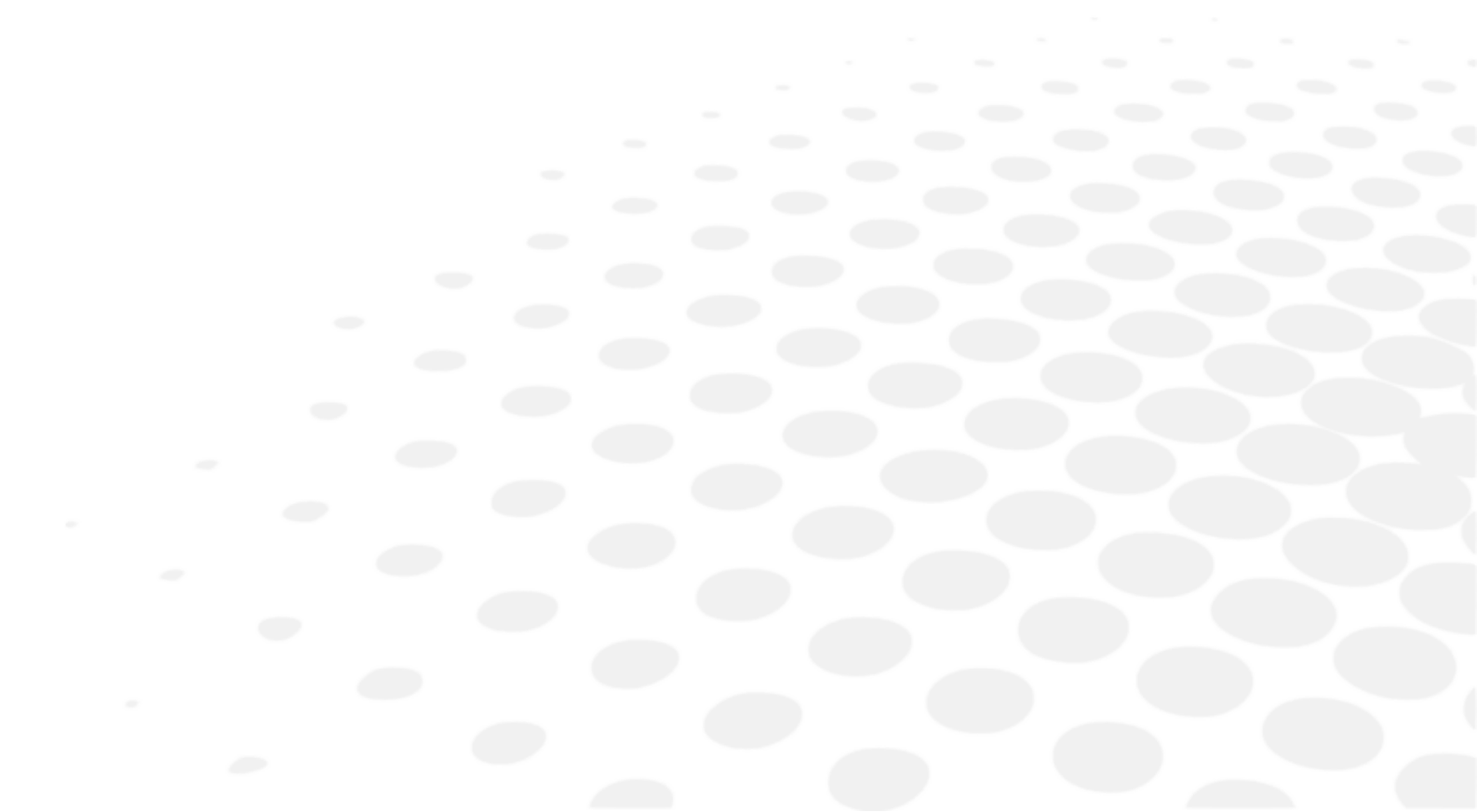



- If you are using the device continuously, both the lens and projector could heat up, increasing the chance of being burned.
- If the device is submitted to a shock or vibrations while in use, both the mask and test might move and no longer be projected accurately. In this case, turn the switch off and back on. The mask and test are once again projected normally.
- The remote control uses infrared rays. If another device is running at the same time on other infrared rays, the CP550 might not operate normally. Should several test projectors be used in the same eye examination room, please contact your retailer.
- If the remote control remains idle for 5 minutes, the lamp automatically turns off. To turn it back on, simply press the LAMP button on the remote control.

## 1. General uses

- 1 Place the switch (7) into the [I] position in order to turn the projector on.
- 2 Select a test to activate lighting of the lamp.



The 37 tests can be selected by pressing keys (16).

> Vision acuity levels are displayed to within tenths on both sides of the mask.

- 3 Through use of the key (18), you can superimpose a red/green filter onto the morphoscopic acuity levels



A complete row or a specific optotype may be isolated using the keys (17). Activating the [Back] and [Next] buttons allows moving this mask onto the projected test.



Whenever applying a mask to either the first or last element of a test, the device makes the transition to the previous or subsequent test and then applies the mask to either the first or last element of this new test.

## 2. List of tests

- Total number of tests: 50 different kinds
- Visual acuity of between 1/20 and 20/10
  - Letters, Landolt rings and Snellen "E" chart: logarithmic scales
  - Numerals and morphoscopic optotypes: decimal scales
- Specific tests:
  - Polarized binocular vision tests: stereoscopy, heterophoria, aniseikonia, binocular and biocular balance (duochrome, double row of numbers)
  - Tests of astigmatism: Parent dial
  - Other: point light source, Worth test
- Filters:
  - Duochrome
- Mask:
  - Vertical and horizontal lines
  - Isolated optotype

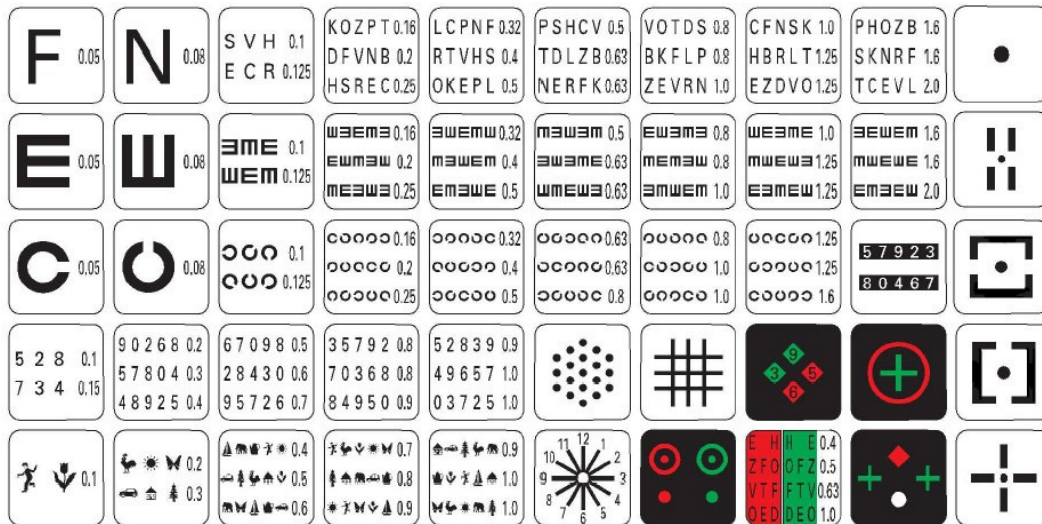



Instrument's range CP550 can all be connected to APH550.

- CP550EA: European optotype
- CP550EB: US optotype

### 3. Program mode

- 1 Hold the [Program 1] or [Program 2] button (15) down for at least 5 seconds.
  - > A signal rings three times, and the device projects the first recorded test and mask pair. The test is projected if no test had been previously recorded.

#### a. Recording a program

- 1 Hold the [Program 1] or [Program 2] button (15) down for at least 5 seconds.
  - > A signal rings three times, and the device projects the first recorded test and mask pair.
  - > The  test is projected if no test had been previously recorded.
- 2  If the [Automatic stop] function has been activated, start by pressing the [Lamp] button for a test to appear, then hold the [Program] button down for at least 5 seconds.
- 2 Use the remote control in order to project the test or mask that you would like to store in memory.
- 3 Press the [Lamp] button to memorize the displayed test or mask.
  - > The sound signal rings one more time and either the  test or memorized test is displayed.
- 4 Repeat steps 2 and 3.





You can record up to 48 different tests. Beyond this number, a signal will ring twice and the projector will indicate that it is unable to enter any more recordings.

- 5 To memorize your programming sequence, press either the [Program 1] or [Program 2] button (15), depending on what you selected in step 1.
  - > A signal sounds three times.
  - > The recording is now completed.
  - > The memorized program is saved even if the device has been turned off.

## b. Special manipulation

---

To:

- return to the **first** test: press  (20) followed by the [Next] button (19)
- return to the **last** test: press  (20) followed by the [Back] button (19)
- delete all recorded tests: press  (20) followed by the [Lamp] button (13) held down for 5 seconds.  
 > A signal will ring three times.

## c. Working in [Program] mode

---

1 Press the [Program 1] or [Program 2] button (15).

> The device projects the first recorded test and mask pair.



If the [Automatic stop] function has been activated, start by pressing the [Lamp] button.

2 Press the [Next] button (22) to project the next recorded test or mask, or press the [Back] button (21) to project the previous test or mask.



If the test or mask happen to be the first ones, a signal will ring twice and the device will indicate the impossibility of shifting any further back.



If you press the [Test/Mask] button, the [Program] mode will stop and the device will return to normal mode. It will also stop if the [Lamp] button is pressed.



After an automatic stop, the device returns to normal mode.

# VI. ERROR DISPLAY

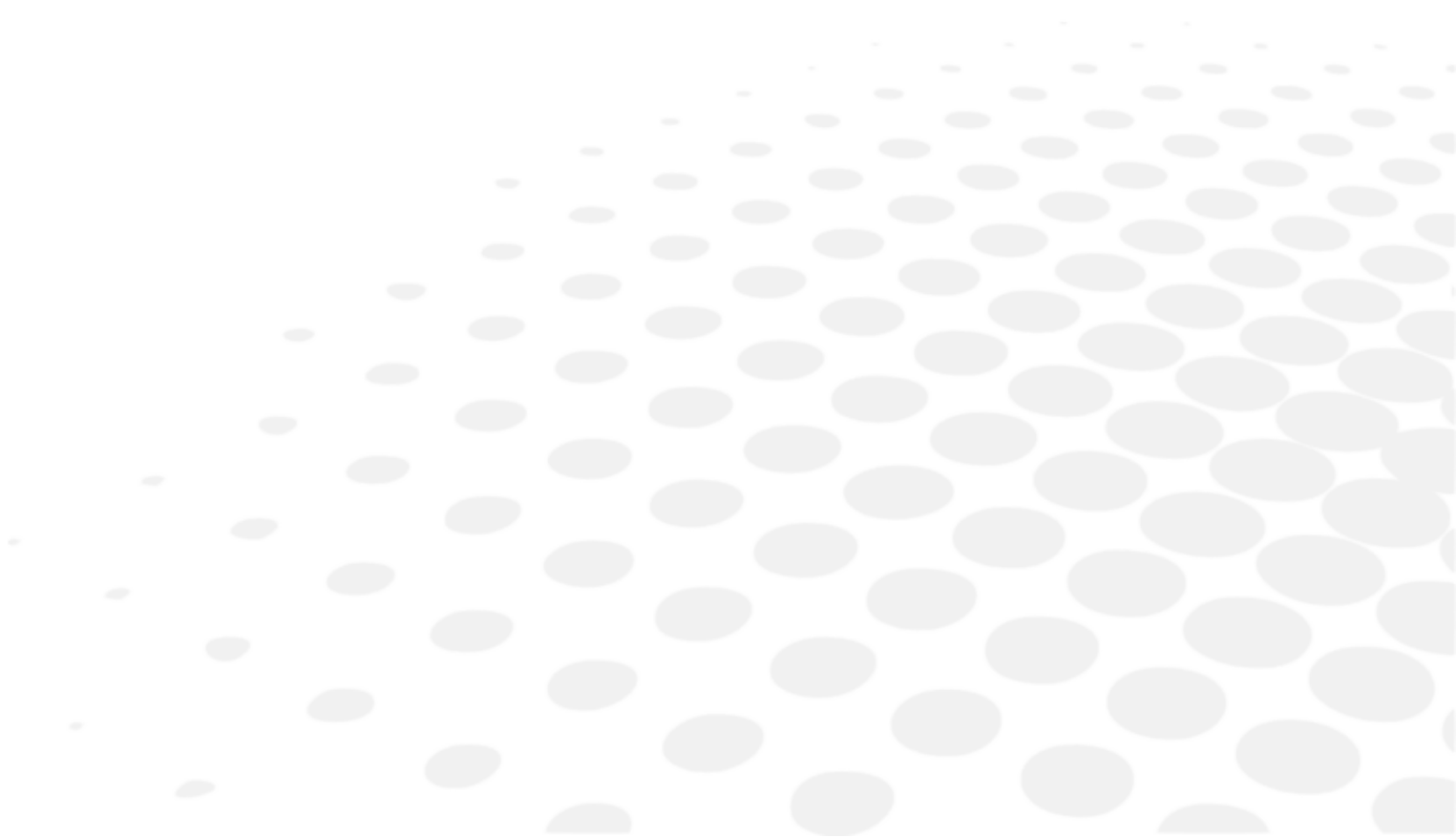

This section is not applicable.

## **VII. SAFETY CONSIDERATION**







Any serious incident that has occurred in relation to the device should be reported to the manufacturer and the competent authority of the Member State in which the user and/or patient is established.

CP 550 is a class I medical device (Regulation (EU) 2017/745).











Basic UDI of the device: 361502CHART-PTB

## 1. Symbols

### a. On the document

SYMBOL	DESCRIPTION
	Caution: a hazardous situation that, if not avoided, could result in minor or moderate injury.
	Warning: a hazardous situation that, if not avoided, could result in death or serious injury.
	Danger: a hazardous situation that, if not avoided, will result in death or serious injury.
	Important and/or useful additional information to learn relating to the text in this manual.
	Tips: practical advice.

### b. On the device and packaging

SYMBOL	DESCRIPTION
	Obligation to refer to the operating manual
	Applied, type B parts.
	Manufacturer
	Manufacturing date (year)
	CE Marking (European regulation relating to medical devices).
	Medical device
	Consult instructions for use or consult electronic instructions for use.
	Fuse
	ON = Turned-on (power supply connected to the mains)
	OFF = Turned-off (power supply disconnected to the mains)

## 2. Precautions for use



- Should you notice something abnormal (noise or smoke), immediately unplug the power supply cable and contact your retailer. In continuing to use the device under such conditions, you run the risk of starting a fire or causing physical damage.
- In the event of malfunction, never attempt to undertake repairs on your own. Contact your retailer.
- Do not reverse the (+/-) polarity of the batteries.
- Never throw a battery into a fire and never try to charge it or heat it.
- Do not combine new and used batteries or batteries of different brands, so as to avoid the risk of battery leakage, overheating or explosion.
- When discarding a battery, always comply with the regulations in effect in your country of residence.
- Ensure that the power supply cable is always clean, free of dust or grease and showing little or no wear. A dirty or worn cable connection may lead to poor operating performance or even fire.
- Never touch the plug prong with wet hands, as this could cause an electrical discharge or bodily injury.
- Never immerse the power supply cable or pour water on it.

## 3. Contraindication

No contraindications.

## 4. Side effects

No undesirable side-effects.

## 5. Exclusion of liability clause



- The results and/or technical data resulting from the handling or use of instruments must be analyzed by professionals experienced in various fields of application of the instrument in order to avoid any risk of misreading or incorrect analysis of the data.
- Diagnostics are carried out under the responsibility of the user and Essilor declines any responsibility for the results of these diagnostics.
- Each instrument constructed, marketed and/or put on the market directly and/or indirectly by Essilor is designed according to the provisions and the regulations in force. It contains the necessary information to ensure the intended use and permitting the identification of the manufacturer, taking into account the training, experience and knowledge of the intended user.
- This information, including that contained in the accompanying product manuals and the technical advice provided, whether oral, written or communicated during a demonstration, is provided on the basis of best knowledge. However, it must be considered as information without any binding effect, including third-party industrial property rights. It does not exempt the customer from checking current versions, communicated advice and suggestions, particularly the technical safety data sheets, instructions and technical information, as well as assessing the capacity of the instruments to ensure the intended use during delivery.
- The application, use and handling of these instruments as well as the products developed by the customer on the basis of technical consulting and/or maintenance activities are not under the control of Essilor. They are therefore the sole responsibility of the customer. Essilor declines any responsibility in the matter, as indicated below.
- The sale of products is governed by the general conditions of sale and delivery as modified.

## 6. Power Source

This section is not applicable.

## 7. Precautions regarding IT Network

This section is not applicable.

## 8. Electromagnetic compatibility

The device conforms to the requirements of the EMC (electromagnetic compatibility) standard.

1. This product needs special precautions regarding EMC and needs to be installed and put into service according to the EMC information provided in this manual.
2. Portable and mobile RF communications equipment can affect medical electrical equipment.
3. The use of accessories, transducers and cables other than those specified, with the exception of transducers and cables sold by the manufacturer of the equipment or system as replacement parts for internal components, may result in increased emissions or decreased immunity of the equipment or system.
4. The equipment or system should not be used adjacent to or stacked with other equipment. If adjacent or stacked use is necessary, the equipment or system should be observed to verify normal operation in the configuration in which it will be used.
5. The use of the accessory, transducer or cable with equipment and systems other than those specified may result in increased emission or decreased immunity of the equipment or system.

PHENOMENON	HOME HEALTHCARE ENVIRONMENT	COMPLIANCE
Conducted and radiated RF emissions	CISPR 11	Class B, Group 1
Harmonic distortion	IEC 61000-3-2	N/A
Voltage fluctuations and flicker	IEC 61000-3-3	Complies

It does not intend to use in aircraft and vehicle.

The emission characteristic of CP550 is for use at industrial area and hospitals (CISPR11 Class A). In case of using this device at domiciliary environment (in this case CISPR11 Class B is required), this device might not be able to provide sufficient protection to the radio-frequency communication service.

The user might need to take countermeasures such as rearrangement or reorientation of the device.

### a. Magnetic and electromagnetic immunity



The product is intended for use in the electromagnetic environment specified below. It is up to the customer or the user to verify that the instrument is used in this environment.

IMMUNITY TEST	TEST LEVEL	COMPLIANCE LEVEL
Electrostatic discharge (ESD) (IEC61000-4-2)	± 8 kV contact ± 15 kV air	± 8kV contact ± 15kV air
Radiated RF EM fields (IEC 61000-4-3)	10 V/m <sup>a</sup> 80 MHz to 2.7 GHz 80% AM at 1 kHz	10V/m
Proximity fields from RF wireless communications equipment (IEC 61000-4-3)	See the table below.	
Rated power frequency magnetic fields IEC 61000-4-8	30 A/m 50 Hz or 60 Hz	30 A/m



<sup>a</sup> Before modulation is applied.

## b. Radiofrequency wireless communications

TEST FREQUENCY (MHz)	BAND <sup>A</sup> (MHz)	SERVICE <sup>A</sup>	MODULATION <sup>B</sup>	MAX POWER (W)	DISTANCE (m)	IMMUNITY TEST LEVEL (V/m)	COMPLIANCE LEVEL
385	380 - 390	TETRA400	Pulse modulation <sup>b</sup> 18Hz	1.8	0.3	27	27
450	430 - 470	GMRS460, FRS460	FM ±5kHz deviation 1kHz sine	2	0.3	28	28
710 745 780	704 - 787	LTE Band 13, 17	Pulse modulation <sup>b</sup> 217Hz	0.2	0.3	9	9
810 870 930	800 - 960	GSM800/900, TETRA800, iDEN820, CDMA850, LTE Band 5	Pulse modulation <sup>b</sup> 18Hz	2	0.3	28	28
1720 1845 1790	1700 - 1990	GSM1800 ; CDMA1900 ; GSM1900 ; DECT ; LTE Band 1, 3, 4, 25 ; UMTS	Pulse modulation <sup>b</sup> 217Hz	2	0.3	28	28
2450	2400 - 2570	Bluetooth, WLAN, 802.11b/g/n, FRID2450, LTE Band 7	Pulse modulation <sup>b</sup> 217Hz	2	0.3	28	28
5240 5500 5785	5100 - 5800	WLAN 802.11a/n	Pulse modulation <sup>b</sup> 217Hz	0.2	0.3	9	9



<sup>a</sup> For some services, only the uplink frequencies are included.

<sup>b</sup> The carrier shall be modulated using a 50% duty cycle square wave signal.

PHENOMENON & BASIC EMC STANDARD	IMMUNITY TEST LEVELS HOME HEALTHCARE ENVIRONMENT	COMPLIANCE LEVEL
Electrical fast transients/ bursts (IEC 61000-4-4)	Input AC power port ± 2kV 100 kHz repetition frequency	± 2kV
	Signal input/ output unit port ±1kV 100 kHz repetition frequency	± 1kV
Surges Line-to-line (IEC 61000-4-5)	± 1kV	
Surges Line-to-ground (IEC 61000-4-5)	± 2kV	
Conducted disturbances induced by RF fields (IEC 61000-4-6)	3 Vrms 0.15 MHz - 80 MHz 6 Vrms in ISM bands between 0.15 MHz and 80 MHz 80% AM at 1 kHz	3 Vrms
Voltage dips (IEC 61000-4-11)	0% $U_T$ ; 0.5 cycle 0°, 45°, 90°, 135°, 180°, 225°, 270° and 315°	0% $U_T$ ; 0.5 cycle
	0% $U_T$ ; 1 cycle and 70% $U_T$ ; 25 cycle Single phase: 0°	0% $U_T$ ; 1 cycle 70% $U_T$ ; 25 cycle
Voltage interruptions (IEC 61000-4-11)	0% $U_T$ ; 250 cycle	0% $U_T$ ; 250 cycle



$U_T$  is the AC supply voltage before applying inspection level.

## VIII. TROUBLESHOOTING



If a problem is detected, refer to the table below in order to take the appropriate measures.

SYMPTOMS	CAUSES AND MEASUREMENTS
The lamp does not light up when the main switch is turned on.	<ul style="list-style-type: none"> <li>• Poor connection of the power supply cable. Place the switch on the "0" position and then firmly plug in the power supply cable.</li> <li>• The fuse has blown. Replace the fuses.</li> </ul>
Imbalanced brightness within the field of vision.	<ul style="list-style-type: none"> <li>• The optical part or test is dirty. Clean the optical part or test.</li> <li>• Incorrect sitting of the LED position. Adjust the position of the LED using a screwdriver.</li> </ul>
The projector does not react when pressing on the remote control buttons.	<ul style="list-style-type: none"> <li>• Depleted batteries. Replace the batteries.</li> </ul>

If the problem has not been resolved after taking the measures listed above, contact your local distributor immediately.

Your dealer has been trained by Essilor.

## **IX. MAINTENANCE**

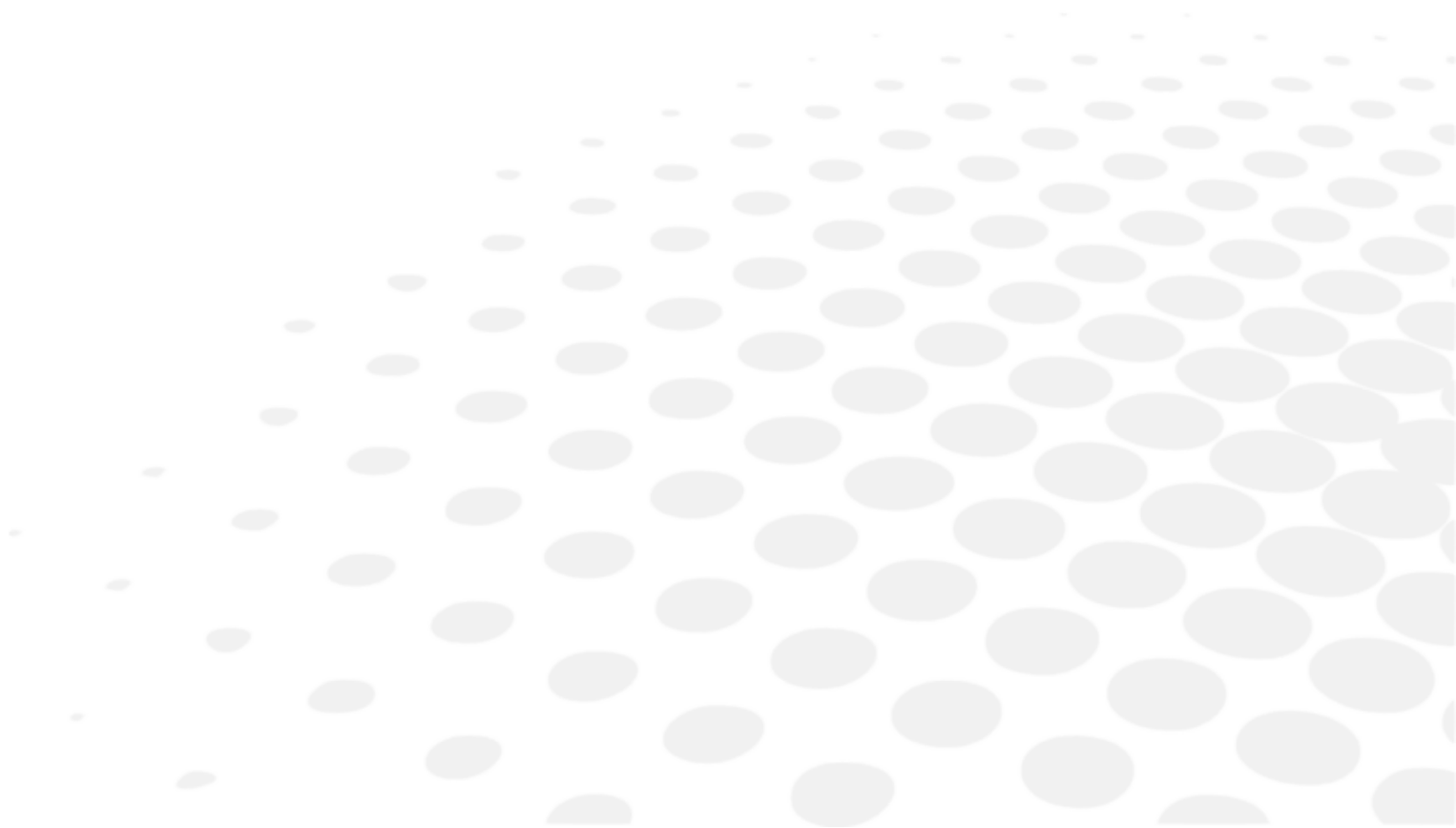

## 1. Storage and handling condition



Respect the operating, storage and transport conditions noted below.

Avoid condensation conditions.

	Temperature	Humidity	Atmospheric pressure
Use	[+10°C; +35°C]	[30 %; 90%]	[800 hPA; 1060 hPA]
Storage	[-10°C; + 55°C]	[10 %; 95%]	[700 hPA; 1060 hPA]
Transport	[-40°C; + 70°C]	[10 %; 95%]	[500 hPA; 1060 hPA]



- When the projector is not in use, protect it with the cover provided by the manufacturer.
- Do not touch any of the optical parts with your fingers and avoid exposing any parts to dust. The dust accumulated on any optical part of the device is to be removed using a brush or a bellows. Should you notice a finger smear or trace of grease on an optical part, apply an alcohol-based cleanser and wipe with a lens cloth or gauze.
- If the projector surfaces are dirty, take the precaution of cleaning them with a dry cloth. For marks that are difficult to remove, we recommend using a damp cloth or neutral detergent.
- Avoid employing organic solvents as these would damage the paint coating of the device.
- If the projector remains idle for awhile, unplug the power supply cable.
- Also, if the projector remains idle for awhile, remove the batteries from the remote control.

## 2. Cleaning

This section is not applicable.

## 3. Periodical inspection and maintenance

This section is not applicable.

## 4. Disassembly of the product and transport

### a. Replacing a fuse

- 1 Unplug the power supply cable (8) to avoid any risk of electrical discharge.
- 2 Remove the fuse holder (9), then replace the fuse.



- If you are not using the appropriate fuse, the device will tend to easily malfunction or potentially cause an accident. Only use the prescribed fuse (250 V, 2 AT).
- The fuse holder contains two fuses. Since you cannot visually identify the defective fuse, remove both and test them individually.
- Anticipate other problem sources should the device continue to malfunction following replacement of the fuse. Immediately unplug the power supply cable and contact the closest product retailer.

### b. Replacing batteries on the remote control

- 1 Pull on the battery compartment lid
- 2 Remove the used batteries and replace them with new ones.
- 3 Position the new batteries as indicated on the sticker at the bottom of the battery compartment



Use two non-corrosive batteries in order to avoid leaks (x 2 LR03 alkaline batteries).

## 5. Disposal



Instructions for the disposal of the instrument in accordance with Directives 2012/19/EU and 2011/65/EU regarding the limitation of dangerous substances in electrical and electronic equipment and the disposal of electrical and electronic waste.

When it reaches the end of its lifetime, the instrument should not be thrown out with the household refuse. It can be disposed of at a waste management center operated by the municipality or the retailers who offer this service.

The separate disposal of an electrical device avoids any damage to the environment or health that could result from a non-compliant disposal, and also allows the materials it is composed of to be recycled in order to save energy and resources.

The pictogram of the wheeled container appears on the label of the instrument. It indicates the obligation for separate collection and disposal of end-of-life/out-of-use electrical and electronic equipment.

# X. SPECIFICATIONS

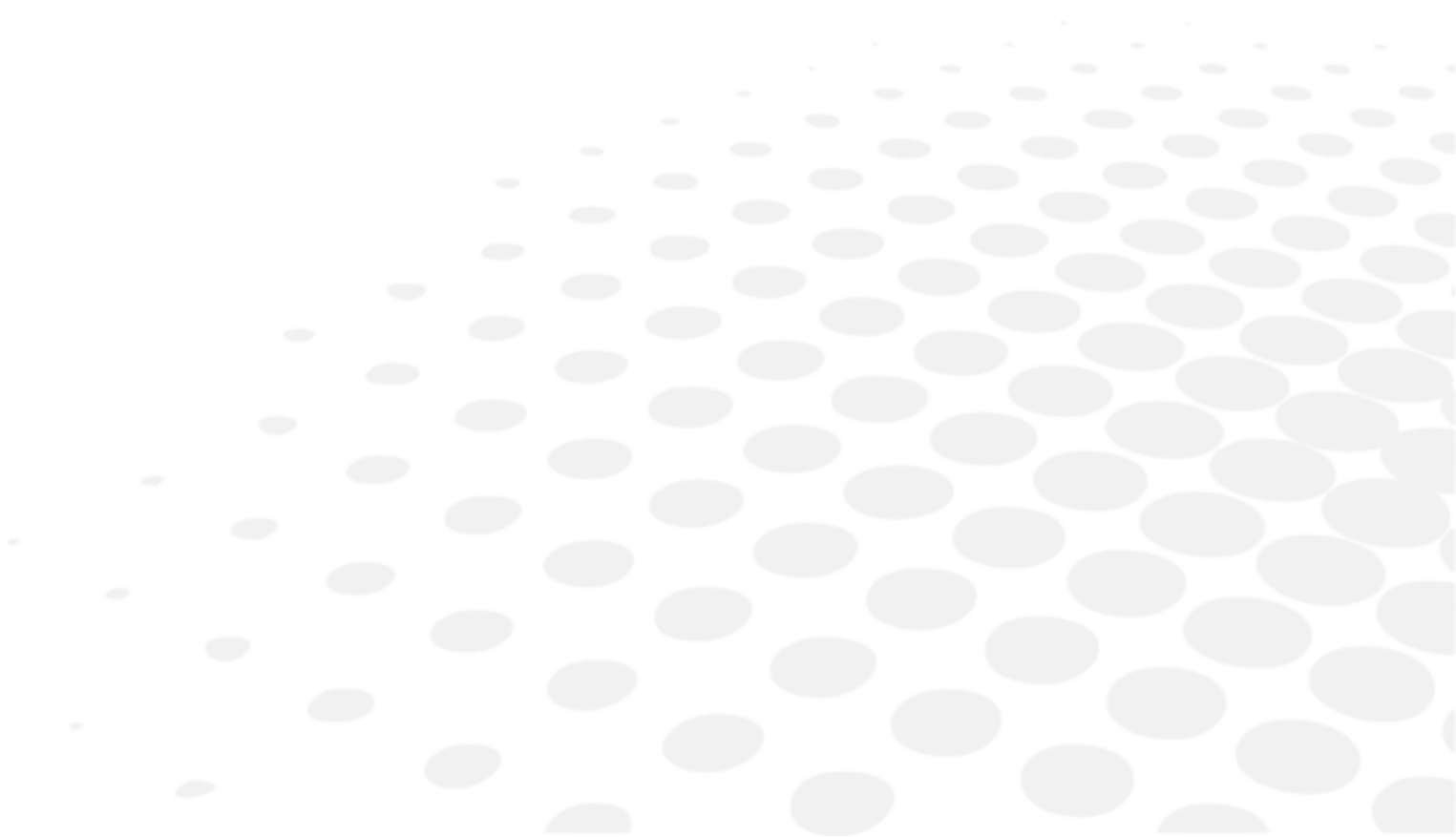

## 1. Technical data

The expected life of the device and its components is xx years.

### a. Projector

---

- Projection distance: 2.0 ~ 7.0 m
- Projection enlargement: x 30 (for a 5-m projection distance)
- Projection field: 335 x 222 mm (for a 5-m projection distance)
- Brightness: 80 ~ 320Cd/m<sup>2</sup> (200Cd/m<sup>2</sup> for a 5-m projection distance)
- Test/mask selection speed: 0.3 seconds
- Program: 2 types (48 tests or masks)
- Angle of inclination: ± 10°
- Dimensions: 248 mm (l) x 336 mm (w) x 234 mm (h)
- Weight: 4.5 kg
- Automatic stop mode: 5 minutes
- Electrical power supply: 100 ~ 240V
- Electrical consumption: 60 VA

### b. Remote control

---

- Type of control: wireless
- Dimensions: 62 mm (l) x 193 mm (w) x 26 mm (h)
- Weight: 100 g

## 2. Connectivity to other devices

This section is not applicable.

## 3. It requirements

This section is not applicable.

## XI. QR CODE

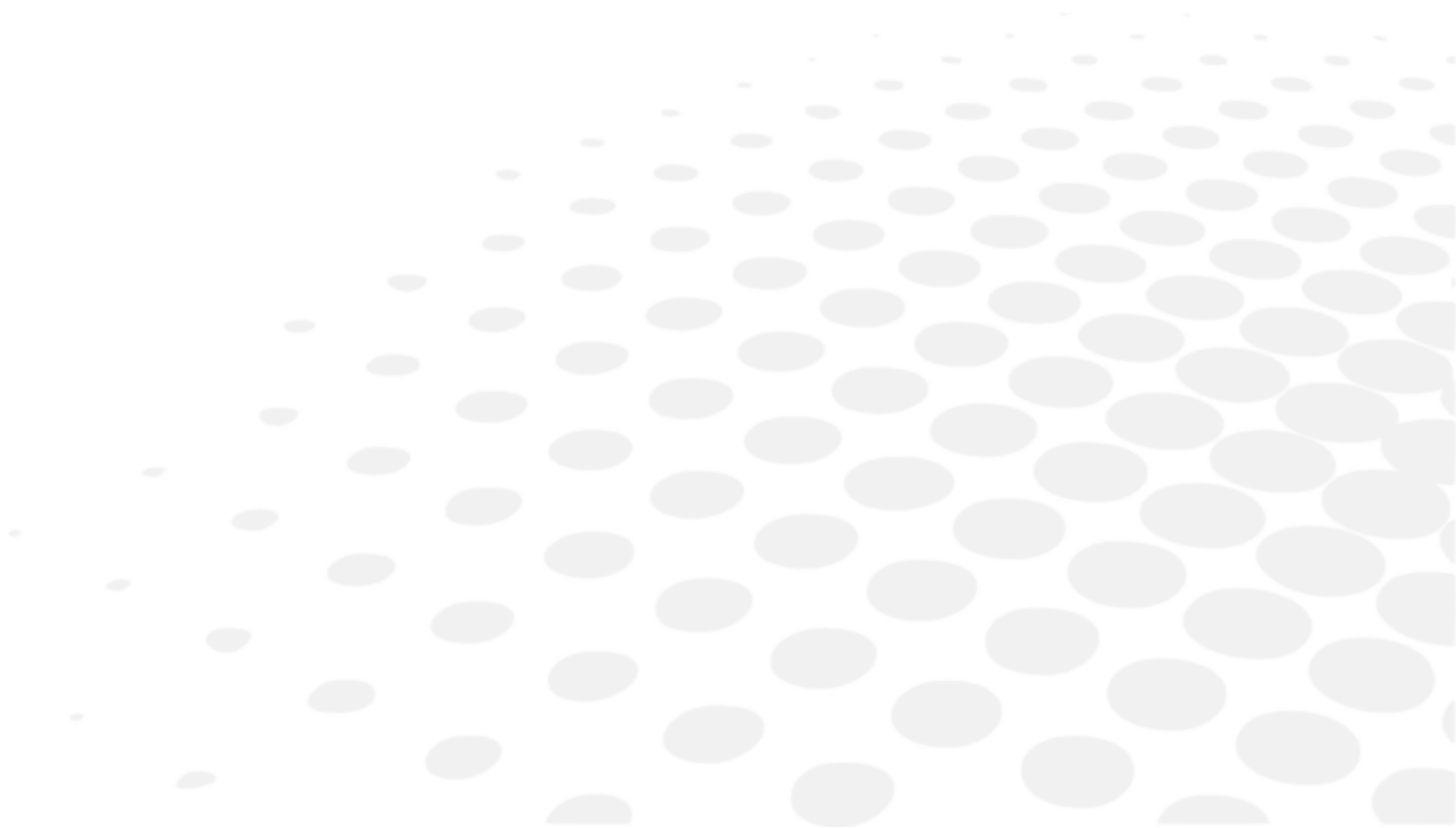

The latest version of the user manual in the appropriate language is available on a web space. Upon request, a paper version can be provided for free.

- en The complete user manual is available on a web space in PDF format. To access it, please scan the QR code below using a dedicated tool or application. Please make sure that your device is suitable and has an appropriate software to display the electronic Instructions for use.
- fr Le manuel utilisateur complet est disponible sur un espace web au format PDF. Pour y accéder, veuillez scanner le QR code ci-dessous à l'aide d'un outil ou d'une application dédié(e). Veuillez vous assurer que votre appareil est compatible et dispose d'un logiciel approprié pour afficher le manuel électronique.
- ar لتتمكن من الوصول إليه، يُرجى مسح رمز الاستجابة السريعة أدناه باستخدام أداة أو تطبيق PDF دليل المستخدم الكامل متوفر من خلال موقع الويب بصيغة مخصص لذلك. يُرجى التأكد من أن جهازك مناسب ويحتوي على برنامج مناسب لعرض التعليمات الإلكترونية الخاصة بالاستخدام.
- be Поўная інструкцыя карыстальніка даступна ў інтэрнэт-прасторы у фармаце PDF. Каб атрымаць да яе доступ, адсканіруйце QR-код ніжэй пры дапамозе спецыяльнага сродку або праграмы. Калі ласка, упэўніцеся, што ваша прылада прыдатная для паказу электроннай Інструкцыі па карыстанню і што на ёй усталявана адпаведнае праграмае забеспячэнне.
- bg Пълното ръководство за потребителя е достъпно в уеб пространството. За да получите достъп до него, моля, сканирайте QR кода по-долу, като използвате специален инструмент или приложение. Моля, уверете се, че вашето устройство е подходящо и разполага с подходящ софтуер за преглед на електронните Инструкции за употреба.
- cs Kompletní uživatelský návod je k dispozici na webovém prostoru ve formátu PDF. Chcete-li k němu získat přístup, naskenujte prosím níže uvedený QR kód pomocí speciálního nástroje nebo aplikace. Ujistěte se prosím, že používáte vhodné zařízení, které má vhodný software pro zobrazení elektronického uživatelského návodu.
- da Den komplette brugervejledning er tilgængelig på et webområde i PDF-format. For at få adgang til den skal du scanne QR-koden nedenfor ved hjælp af et dedikeret værktøj eller program. Sørg for, at din enhed er egnet og har en passende software til at vise de elektroniske brugsanvisninger.
- de Die vollständige Bedienungsanleitung ist auf einem Webspace im PDF-Format verfügbar. Für den Zugriff scannen Sie bitte den untenstehenden QR-Code mit einem speziellen Tool oder einer Anwendung. Bitte vergewissern Sie sich, dass Ihr Gerät für die Anzeige der elektronischen Gebrauchsanweisungen geeignet ist und über eine entsprechende Software verfügt.
- el Το πλήρες εγχειρίδιο χρήσης είναι διαθέσιμο σε έναν ιστοχώρο σε μορφή PDF. Για να αποκτήσετε πρόσβαση σε αυτό, σκανάρετε τον κωδικό QR παρακάτω χρησιμοποιώντας ένα ειδικό εργαλείο ή εφαρμογή. Βεβαιωθείτε ότι η συσκευή σας είναι κατάλληλη και έχει το κατάλληλο λογισμικό για την προβολή των ηλεκτρονικών οδηγιών χρήσης.
- es El manual de uso completo está disponible en un espacio web. en formato PDF. Para acceder a él, escanee el código QR debajo utilizando una herramienta o aplicación dedicada. Asegúrese de que su dispositivo sea adecuado y tenga el software apropiado para mostrar las Instrucciones de uso electrónicas.
- et Täielik kasutusjuhend on saadaval veebis PDF-vormingus. Juurdepääsuks palun skannige allolevat QR-koodi, kasutades selleks vastavat tööriista või rakendust. Veenduge, et teie seade sobib ja et selles on elektroonilise kasutusjuhendi kuvamiseks sobiv tarkvara.
- fi Täysi käyttöopas on saatavana verkosta PDF-muodossa. Saat pääsyn siihen skannaamalla alla olevan QR-koodin käyttäen siihen tarkoitettua työkalua tai sovellusta. Varmista, että laitteesi on sopiva ja sisältää asianmukaisen ohjelmiston sähköisten käyttöohjeiden esittämiseen.
- hr Potpun korisnički priručnik dostupan je na mrežnom prostoru u PDF formatu. Da biste mu pristupili, skenirajte QR kod u nastavku pomoću odgovarajućeg alata ili aplikacije. Provjerite je li vaš uređaj prikladan i ima li odgovarajući softver za prikaz elektroničkih uputa za upotrebu.
- hu A teljes felhasználói kézikönyv elérhető az interneten PDF formátumban. Eléréséhez olvassa be az alábbi QR-kódot egy erre szolgáló eszközzel vagy alkalmazással. Ellenőrizze, hogy eszköze képes és rendelkezik a megfelelő szoftverrel az elektronikus használati útmutató megjelenítésére.

- id Panduan pengguna lengkap tersedia di ruang web dalam format PDF. Untuk mengaksesnya, silakan pindai kode QR di bawah ini menggunakan alat atau aplikasi khusus. Pastikan peranti Anda sesuai dan memiliki perangkat lunak yang layak untuk menampilkan petunjuk penggunaan elektronik.
- it Il manuale utente completo è disponibile in formato PDF su uno spazio Web. Per accedervi, leggere il codice QR sottostante mediante un apposito strumento o un'applicazione dedicata. Assicursi che il dispositivo sia adatto e che disponga di un software appropriato per visualizzare le istruzioni per l'uso in formato elettronico.
- ja 完全なユーザーマニュアルは、PDF形式でウェブスペースから入手できます。アクセスするには、専用のツールまたはアプリケーションを使用して、以下のQRコードをスキャンしてください。お使いのデバイスが適切であり、電子説明書を表示する適切なソフトウェアがインストールされていることを確認してください。
- ko 전체 사용 설명서는 웹 공간에 PDF 형식으로 있습니다. 이 설명서에 액세스하려면, 전용 도구 또는 앱을 사용하여 아래 QR 코드를 스캔하십시오. 사용자의 기기가 적합하고 전자적인 사용 설명서를 표시할 수 있는 적절한 소프트웨어가 있는지 확인하시기 바랍니다.
- lt Išsamaus naudotojo vadovo PDF formatu ieškokite interneto svetainėje. Kad jį atvertumėte, specialiu įrankiu arba programėle nuskaitykite toliau pateiktą QR kodą. Įsitinkite, kad jūsų įrenginys yra tinkamas ir turi tinkamą programinę įrangą elektroninems naudojimui instrukcijoms rodyti.
- lv Pilnā lietotāja instrukcija ir pieejama tīmeklī PDF formātā. Lai tai piekļūtu, lūdzu, noskenējiet tālāk redzamo kvadrāt kodu, izmantojot tam paredzētu rīku vai lietojumprogrammu. Lūdzu, pārlicinieties, vai jūsu ierīce ir piemērota un vai tai ir atbilstoša programmatūra elektroniskās lietotāja instrukcijas attēlošanai.
- ms Manual pengguna yang lengkap boleh didapati di ruang laman dalam format PDF. Untuk mengaksesnya, sila imbas kod QR di bawah menggunakan alat atau aplikasi khusus. Sila pastikan yang peranti anda adalah serasi dan mempunyai perisian yang sesuai untuk memaparkan Arahan elektronik untuk tujuan penggunaan.
- nl De volledige gebruikershandleiding is in PDF-formaat beschikbaar op een website. U kunt de handleiding bereiken door de QR-code hiernaast te scannen met een geschikte applicatie. Uw apparaat moet geschikt zijn en over de juiste software beschikken om de elektronische gebruiksaanwijzing weer te geven.
- no Den komplette brukerhåndboken er tilgjengelig på et webhotell i PDF-format. For å få tilgang til den, skann QR-koden nedenfor ved hjelp av et dedikert verktøy eller applikasjon. Sørg for at enheten din er egnet og har en passende programvare for å vise den elektroniske bruksanvisningen.
- pl Kompletna instrukcja użytkownika jest dostępna na stronie internetowej w formacie PDF. Aby uzyskać dostęp, zeskanuj poniższy kod QR przy użyciu dedykowanego narzędzia lub aplikacji. Upewnij się, że urządzenie jest zgodne i wyposażone w odpowiednie oprogramowanie pozwalające wyświetlać elektroniczną Instrukcję obsługi.
- pt O manual do utilizador completo está disponível num espaço online no formato PDF. Para aceder a este, queira digitalizar o QR Code abaixo usando uma ferramenta ou uma aplicação dedicada. Certifique-se de que o seu dispositivo é compatível e possui um software apropriado para exibir as instruções eletrónicas de utilização.
- pt (brazil) O manual do usuário completo está disponível em um espaço online no formato PDF. Para acessar a este, por favor, digitalizar o QR Code abaixo usando uma ferramenta ou um aplicativo dedicado. Seu dispositivo deve ser compatível e possuir um software apropriado para exibir as instruções eletrônicas de utilização.
- ro Manualul de utilizare complet este disponibil online în format PDF. Pentru a-l accesa, scanați codul QR de mai jos folosind un instrument sau o aplicație dedicată. Asigurați-vă că dispozitivul dumneavoastră este potrivit și are un software adecvat pentru afișarea Instrucțiunilor de utilizare în format electronic.
- ru Полное руководство пользователя доступно в интернет-пространстве в формате PDF. Чтобы получить к нему доступ, отсканируйте QR-код ниже с помощью специального инструмента или приложения. Убедитесь, что ваше устройство подходит и имеет соответствующее программное обеспечение для отображения электронных инструкций по эксплуатации.
- sk Celý používateľský manuál je dostupný vo webovom priestore vo formáte PDF. Ak chcete získať prístup, naskenujte nižšie uvedený QR kód pomocou špeciálneho nástroja alebo aplikácie. Uistite sa, že máte vhodné zariadenie s vhodným softvérom na zobrazenie elektronickeho návodu na použitie.

- sl Celoten uporabniški priročnik je na voljo kot dokument PDF na spletnem mestu. Za dostop optično preberite spodnjo kodo QR z namenskim orodjem ali aplikacijo. Prepričajte se, da je vaša naprava primerna in ima ustrezno programsko opremo za prikaz elektronskih navodil za uporabo.
- sr Kompletno uputstvo za korisnike je dostupno na veb prostoru u PDF formatu. Da biste mu pristupili, skenirajte QR kôd u nastavku pomoću namenske alatke ili aplikacije. Proverite da je vaš uređaj odgovarajući i da li ima potreban softver za prikaz elektronskog Uputstva za upotrebu.
- sv Den fullständiga bruksanvisningen finns tillgänglig på ett webbutrymme i PDF-format. För att komma åt den, vänligen skanna QR-koden nedan med ett dedikerat verktyg eller program. Se till att din enhet är lämplig och har en passande programvara för att visa de elektroniska användningsinstruktionerna.
- th สามารถรับคู่มือผู้ใช้ฉบับสมบูรณ์ในรูปแบบ PDF ได้จากบนเว็บไซต์ โดยในการเข้าถึง โปรดสแกนคิวอาร์โค้ดด้านล่างด้วยเครื่องมือหรือแอปพลิเคชันเฉพาะ โปรดตรวจสอบให้แน่ใจว่าอุปกรณ์ของคุณนั้นเหมาะสม และมีซอฟต์แวร์ที่สามารถใช้ในการแสดงคำแนะนำการใช้งานอิเล็กทรอนิกส์ได้อย่างถูกต้อง
- tr Kullanım kılavuzunun tamamı web alanında, PDF formatında mevcuttur. Buna erişmek için lütfen uygun bir araç veya uygulama kullanarak aşağıdaki QR kodunu okutun. Lütfen cihazınızın uyumlu ve elektronik kullanım talimatlarını görüntülemek için uygun bir yazılıma sahip olduğundan emin olun.
- uk Повна версія посібника користувача доступна в інтернеті в форматі PDF. Щоб отримати до нього доступ, скануйте QR-код нижче за допомогою спеціального додатку. Для перегляду електронного посібника користувача на вашому пристрої він повинен мати відповідні характеристики та програмне забезпечення.
- vi Hướng dẫn sử dụng đầy đủ có sẵn trên không gian web ở định dạng PDF. Để truy cập, vui lòng quét mã QR bên dưới bằng công cụ chuyên dụng hoặc bằng ứng dụng. Vui lòng đảm bảo rằng thiết bị của bạn phù hợp và có phần mềm phù hợp để hiển thị Hướng dẫn sử dụng điện tử
- zh 完整的操作手册以 PDF 格式在网络上提供。如需获取，请使用专门的工具或应用程序扫描下方二维码。请确保您的设备适用并安装有相应的软件，能够显示电子版使用说明。





Essilor International  
147, rue de Paris – 94220 Charenton-le-Pont France  
[www.essilor.com](http://www.essilor.com)

