

# VISION-C 600



USER MANUAL

# CONTENTS

<b>I. INTRODUCTION</b>	<b>4</b>
<b>II. SUPPLY PACKAGE</b>	<b>6</b>
1. Unpacking and storage	7
2. List of accessories	8
<b>III. GENERAL DESCRIPTION</b>	<b>9</b>
1. Intended use	10
a. Intended purpose	10
b. Indications for use	10
c. Expected clinical benefit	10
d. Intended population	10
e. Intended users	10
2. Device description	10
a. Front face	10
b. Rear face	10
c. Connection	11
<b>IV. INSTALLATION / CONNECTION</b>	<b>12</b>
1. Installation of the device	13
a. Installation of VESA brackett	14
b. Installation of the power cord holder	17
2. Turning ON/OFF	18
a. Turn on the instrument	18
b. Turn off the instrument	19
3. Connection to other instruments	19
<b>V. ADJUSTMENTS BEFORE THE EXAMINATION</b>	<b>20</b>
1. Positioning the screen	21
2. Settings	21
a. Configuring the screen	21
b. Adjusting optotypes from console	23
<b>VI. UPDATE THE SCREEN</b>	<b>30</b>
1. Update by USB key	31
2. By LAN (IP)	34
<b>VII. ERROR DISPLAY</b>	<b>37</b>
<b>VIII. SAFETY CONSIDERATION</b>	<b>39</b>
1. Symbols (device & packaging)	40
a. On the document	40
b. On the device and packaging	40
2. Precautions for use	41
3. Contraindication	41
4. Side effects	42
5. Exclusion of liability clause	42
6. Power source	42
7. Precautions regarding IT Network	43
8. Electromagnetic compatibility	43
a. Length of cables, cords, etc.	44

---

b. Recommended separation distance	44
c. Electromagnetic emissions	44
d. Magnetic and electromagnetic immunity	44
e. Electromagnetic immunity, radio frequencies	45
<b>IX. TROUBLESHOOTING</b>	<b>46</b>
<b>X. MAINTENANCE</b>	<b>48</b>
1. Storage and handling condition	49
2. Cleaning	49
3. Periodical inspection and maintenance	49
4. Disassembly of the product and transport	49
5. Disposal	50
<b>XI. SPECIFICATIONS</b>	<b>51</b>
1. Technical data	52
a. Dimensions and weight	52
b. LEDs specifications	52
2. Connectivity to other devices	52
3. It requirements	52
<b>XII. QR CODE</b>	<b>53</b>

# I. INTRODUCTION



 The latest version of this user manual is available on a web space.  
To access other available languages, please scan the QR code available at the end of this user manual > QR Code Chapter. (p.53)

For a safer, more effective use, follow the instructions outlined in this manual.

Copyright © 2023 Essilor - Original manual - All rights reserved.

All reproduction of the content of this document, whether in part or as a whole, for the purpose of its publication or dissemination by any means and in any format whatsoever, even free of charge, is strictly prohibited without Essilor's prior written consent.

## II. SUPPLY PACKAGE

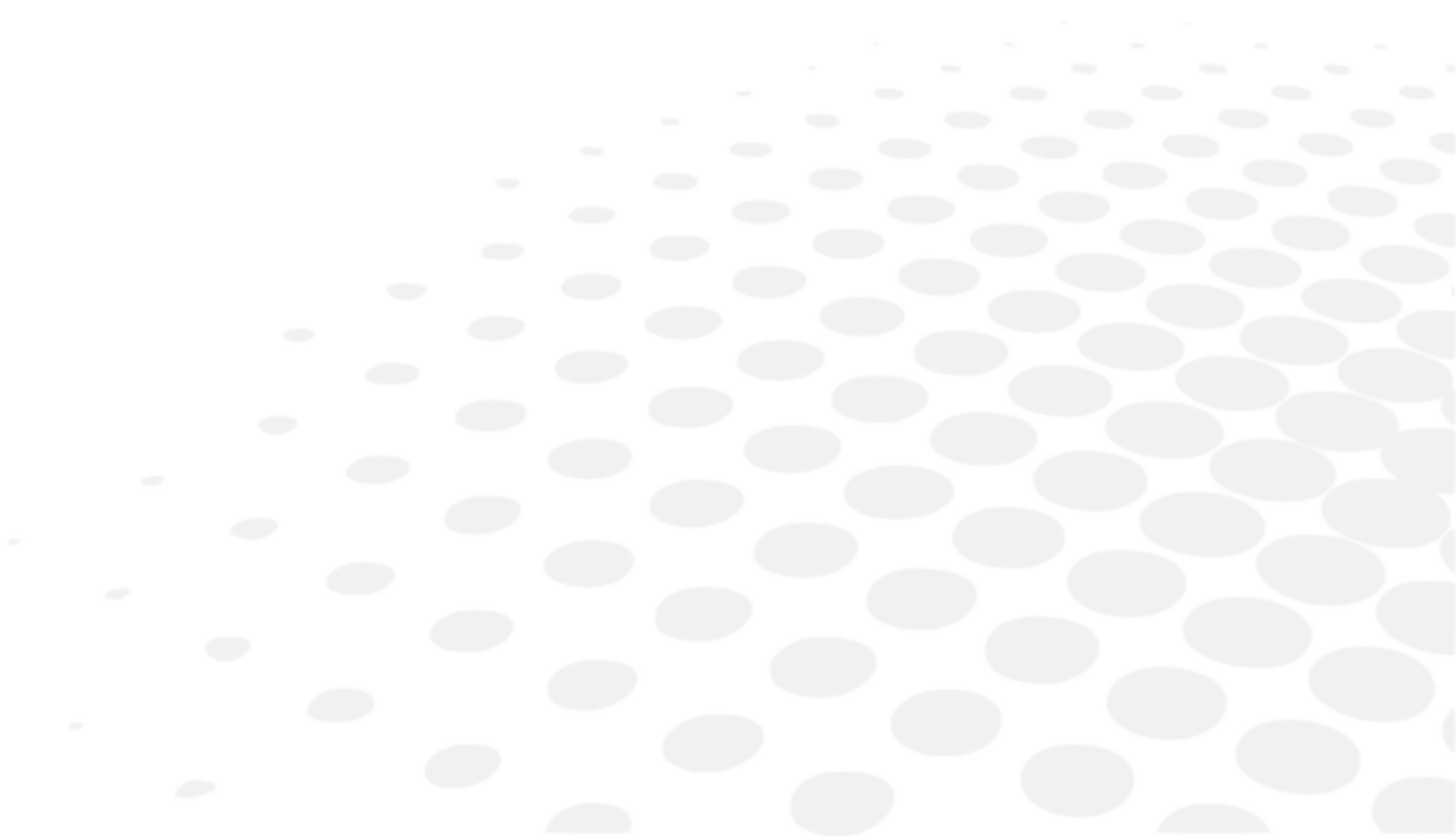

## 1. Unpacking and storage

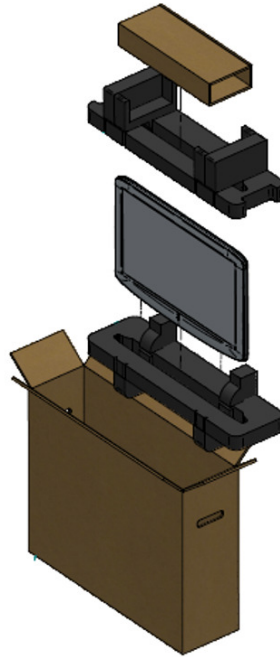

- 1 Open the box and remove the accessories box.



- 2 Remove the foam.



- 3 Gently remove the screen out of the box.



- 4 Remove the protective cover.

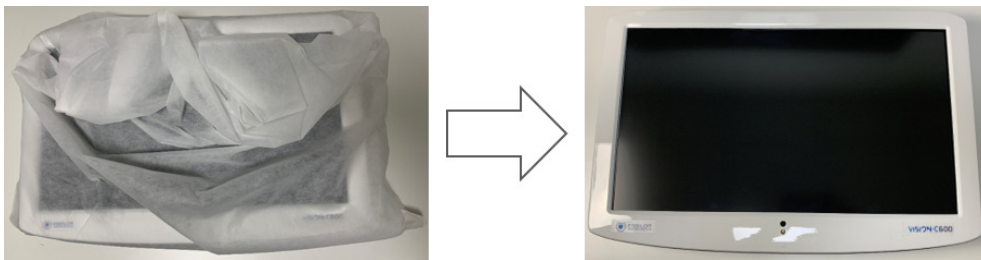

## 2. List of accessories

While unpacking, check that the following standard accessories are included.

### Standard accessories and detachable parts

- Power supply\* (x1)
- Ethernet cable, 2m (x1)
- Power cable\*, 1.80m (x2)
  - US: ref CA6096
  - Europe: ref VRSA05
- Wall mounting bracket (x1)
- Power cable holder (x1)
- User manual (x1)

\* Applied parts



Vision-C 600 is entirely compatible and designed to work with the Vision-R™ phoropters.

### **III. GENERAL DESCRIPTION**



## 1. Intended use

### a. Intended purpose

Vision-C 600 (VRS001) is a visual chart system, stand-alone type, which displays broad range of charts, based on LCD panel.

### b. Indications for use

This section is not applicable.

### c. Expected clinical benefit

This section is not applicable.

### d. Intended population

This section is not applicable.

### e. Intended users

This device is intended for eye care professionals use only.

## 2. Device description

The Vision-C 600's main components are shown below.

### a. Front face



### b. Rear face

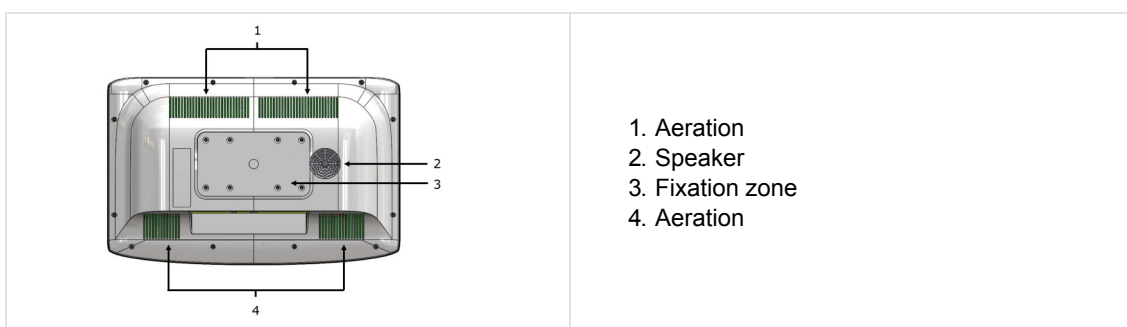

### c. Connection

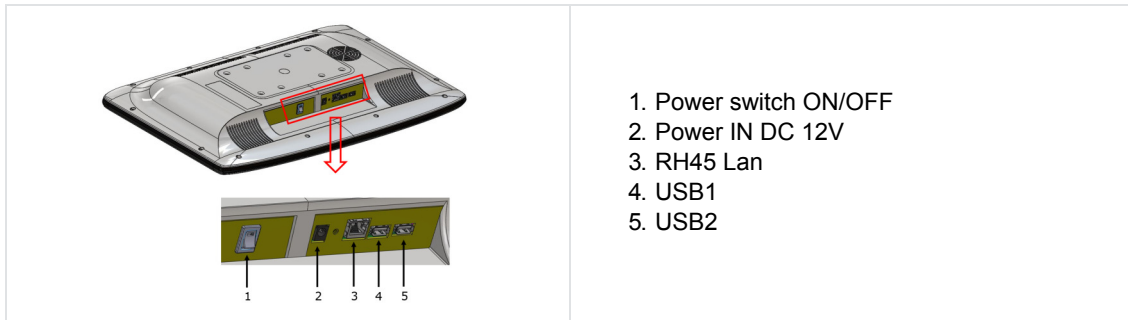

## **IV. INSTALLATION / CONNECTION**

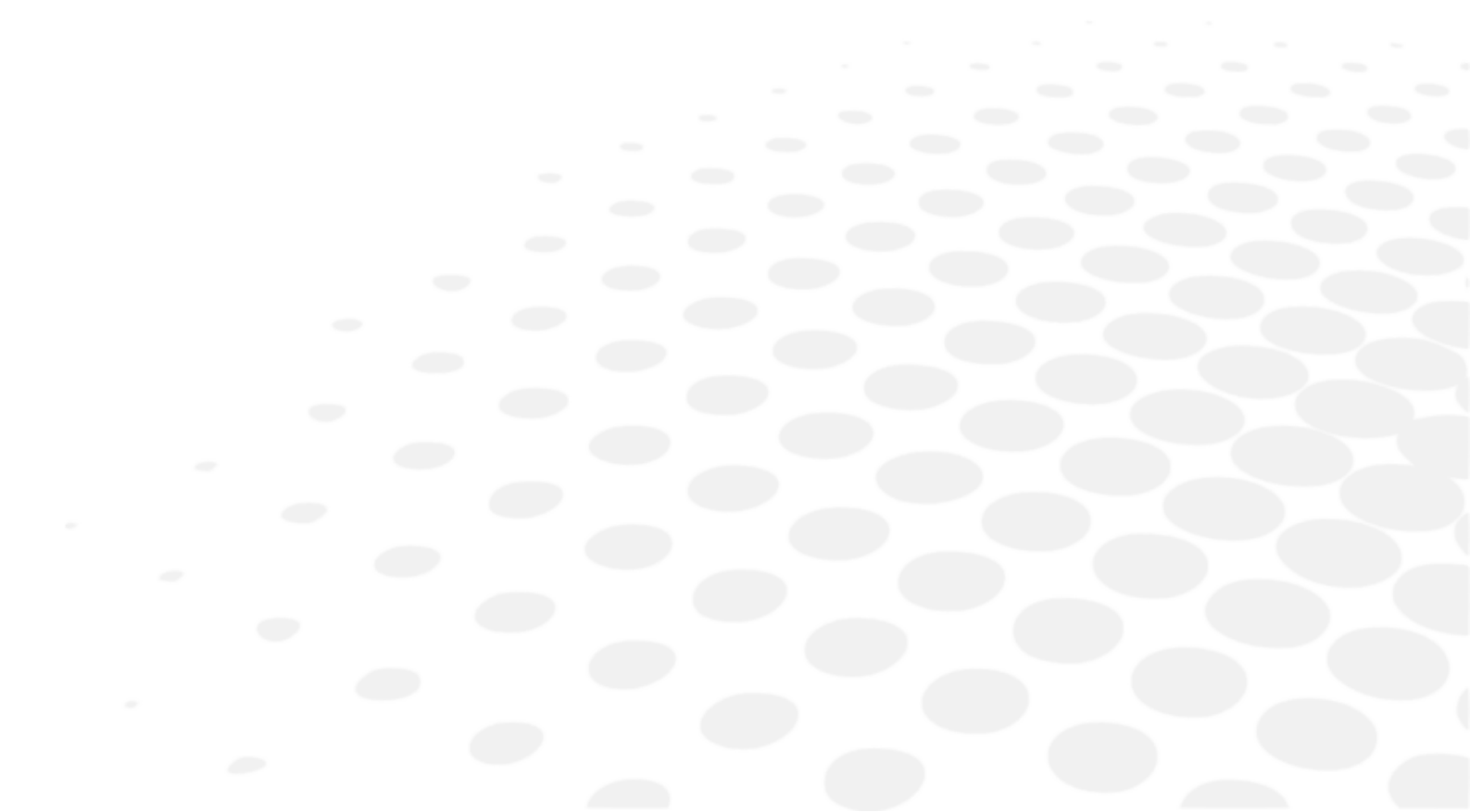



This instrument must be installed by a specialized technician. To install the instrument or to change its connection, please contact your Essilor dealer.

Respect the precautions below:

- Do not install the instrument in a location:
  - where dust or dirt accumulates,
  - directly exposed to the light rays,
  - oxygen rich,
  - displaying extreme temperatures and humidity levels,
  - likely to undergo strong oscillations or sudden shocks.
- Do not use the instrument with flammable anaesthetics or in conjunction with flammable agents.
- The instrument should not fall; that would likely cause malfunctions. If it does fall, the instrument could also crush your body or feet.
- Be sure to mount the device away from a power outlet.
- Do not push the inserts too far into the wall.

## 1. Installation of the device



1. Find a suitable point on the wall to attach the wall mount bracket that will support the product.

> Make sure that the refraction distance meets the requirements for either direct view or mirror arrangement.

2. Level the supplied wall mount bracket with the metal tabs facing up and out on your wall and mark the holes for the installation.





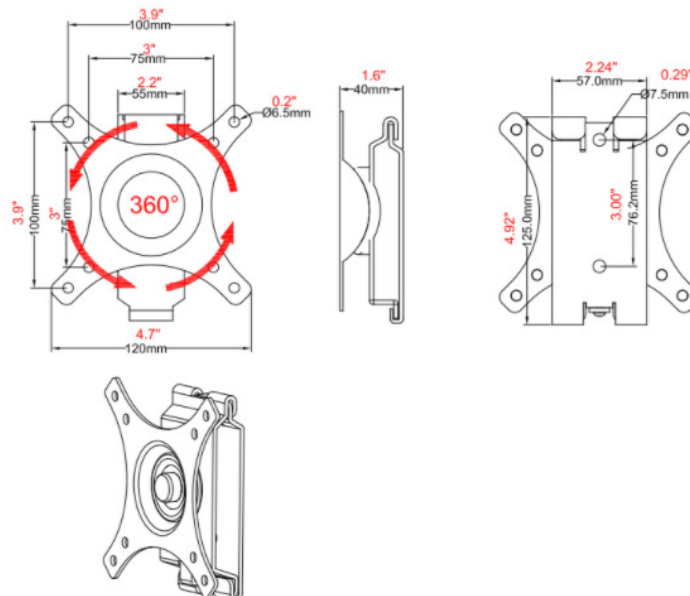

3. Place the wall mount bracket on the wall, and screw or tap the screws (nail) into the holes.

4. Hang the product by lining up the holes on the back of the unit with the metal strips of the wall mount bracket and hang the unit on these strips.

### Size



**Components**

DESCRIPTION	VISUAL
Screen plate, ion plate (x1)	
Wall plate	
Screw M4x16mm, ref. CV6273 (x4)	
Fastening screw ST6.3*65 vmm (x2)	
Expansion pipe (x2)	
Washer (x2)	

**a. Installation of VESA brackett**

- 1 Unscrew and remove the part to be fixed on the wall.

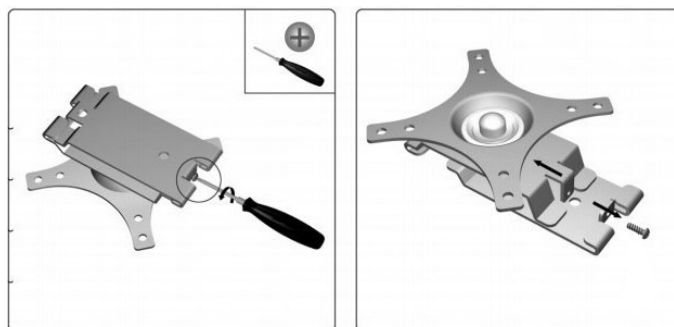

- 2 Position the wall part in order to mark the 2 fixing points then, drill.

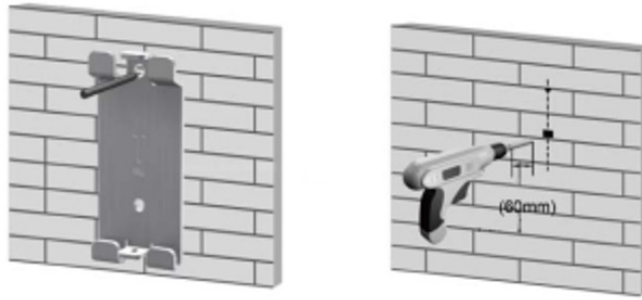

- 3 Fit the wooden dowel provided.



- 4 Screw the wall part of the support.



- 5 Screw the other part with the 4 screws ref CV6273 (M4x16mm).



**6** Position the screen from above as shown below.

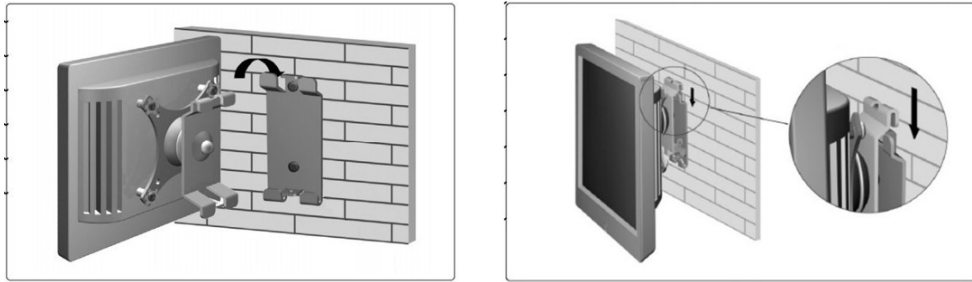

**7** Screw the security screw.

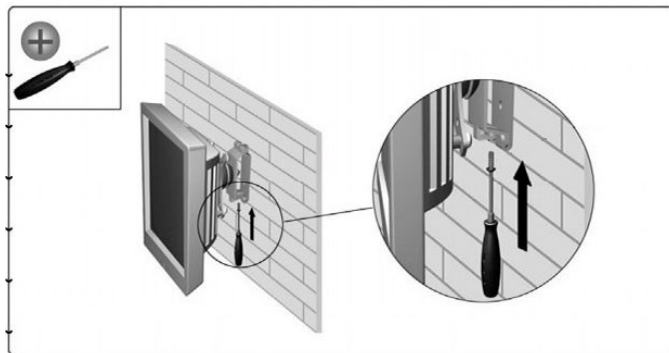

**8** Adjust the screen angle as needed.

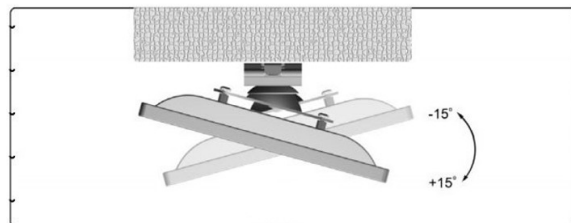
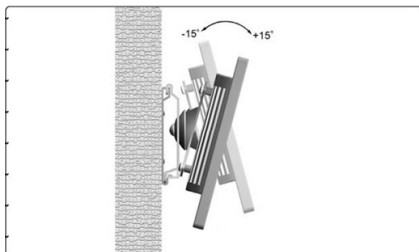

It is also possible put the chart screen on a support (ref. CS510).



## **b. Installation of the power cord holder**

- 1 Put the power cable mounting holder.



- 2 Screw the support to the right location.



The screw is supplied.



- > The power cord holder is mounted.



## 2. Turning ON/OFF

### a. Turn on the instrument

- 1 Press the ON/OFF switch on the chart screen.

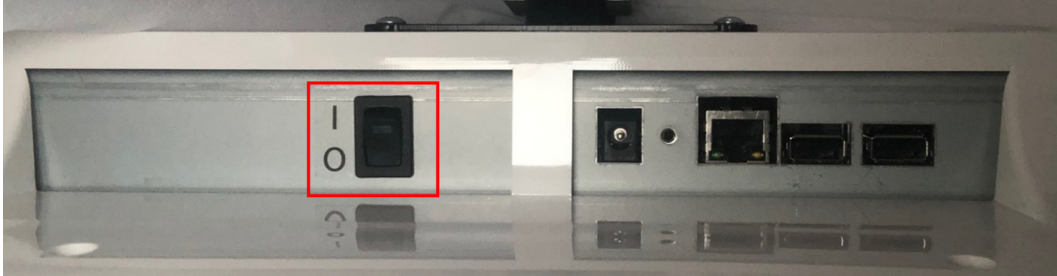

- > The screen switch on.

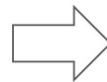

You can check the connection between the console keypad and the screen by clicking on the optotypes (they should appear on the screen).

- > The instrument is ready to be used.

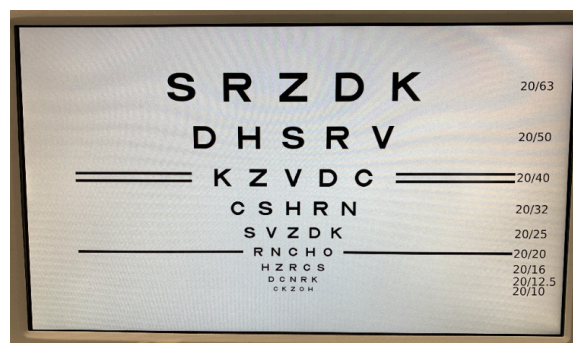

## b. Turn off the instrument

### Turn off the instrument

- 1 Press the ON/OFF switch on the chart screen.

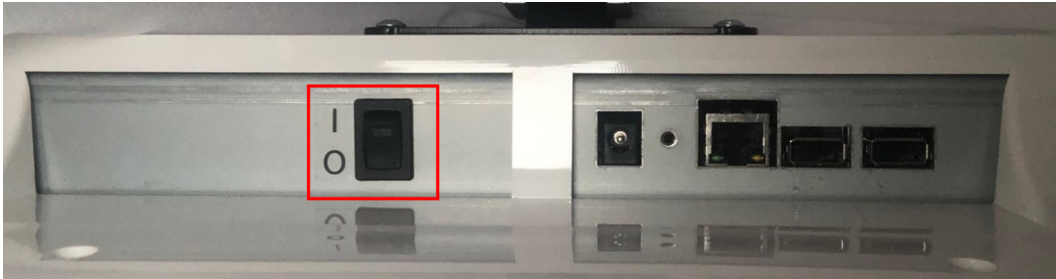

> The screen switch off.

## 3. Connection to other instruments

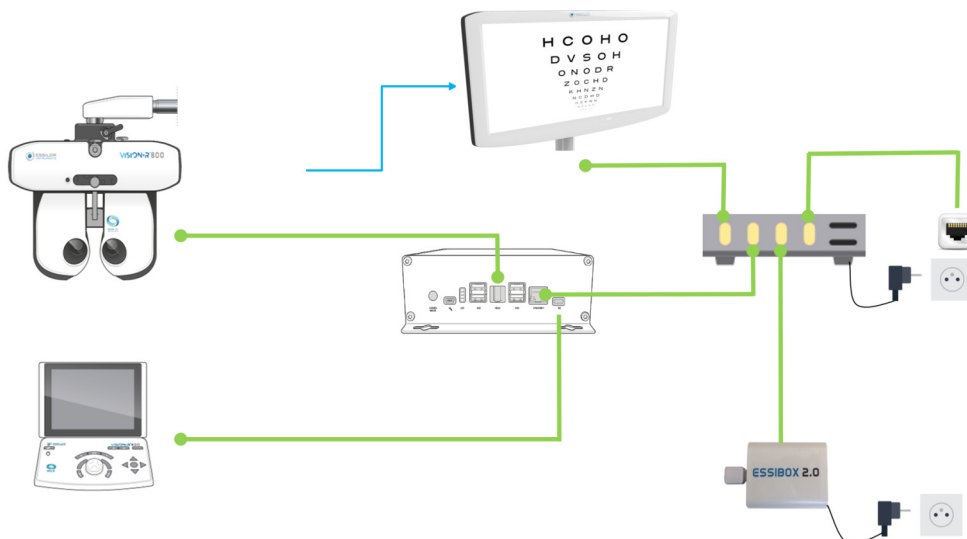

### With:

- █ Cable connection
- █ Infra-red connection

## **V. ADJUSTMENTS BEFORE THE EXAMINATION**



## 1. Positioning the screen

Please put the product so that the center of the LCD screen is at the level of patient's eyes.

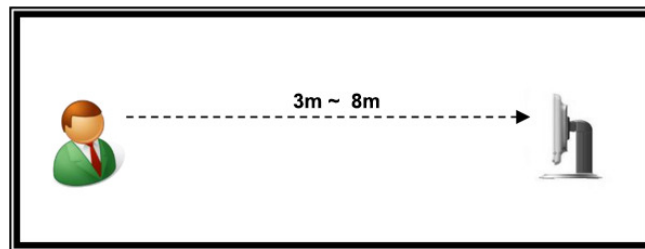



Optotypes are generated based on screen adjustment distances.

## 2. Settings

### a. Configuring the screen

All the Vision-C 600 settings are configured on the console of the Vison-R.

It is possible to modify the default settings of the screen by pressing on  >  of the console.

> The instrument settings page is displayed.

> Then click on .

> The following page appears:

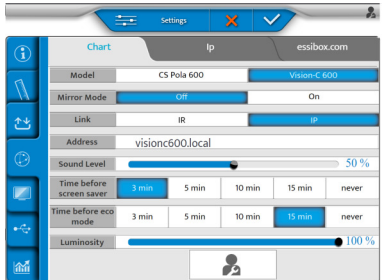
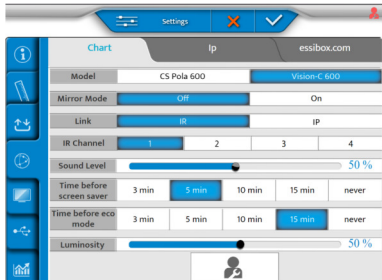
For IP connection	For IR connection
	



The [Vision-C 600 Configuration] button calls the popup of the Vision-C 600 configuration. This button is only available in technician mode.

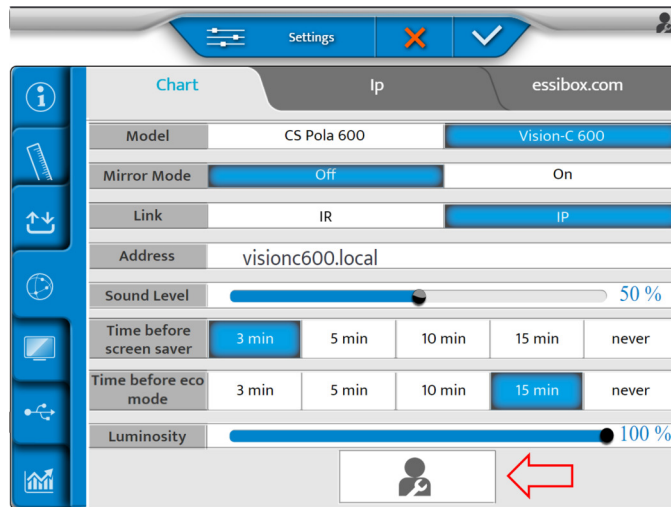

Now you can set the following settings:

- [Model]
- [Mirror mode]
- [Link]
- [Address]
- [Sound level]
- [Time before screen saver]
- [Time before eco mode]
- [Luminosity]



When [Chart Type] is set on [Vision-C 600], the IP communication is available. If the IP communication is set, [IR Channel] is replaced by [IP Address].

When [Vision-C 600] is selected, [Time before eco mode] and [Time before screen saver] are available as the [Vision-C 600 Configuration] button.

Click on [Vision-C 600 Configuration] button, the following pop up appears:

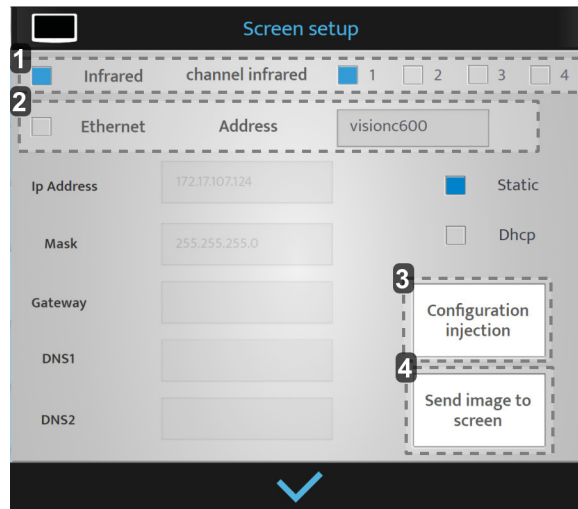

**1. [Infrared]**

Only when the [IR] is selected.

2. [Ethernet]

Only when the [Ethernet] is selected.

> It is the name of the screen (it can take 12 characters).

3. [Configuration injection]

The settings are sent to the chart screen.

4. [Send image to Vision-C 600]



An image is sent to the chart screen in order to test the connection.

Once the adjustments are made, press on:

-  to confirm.
-  to cancel.

**b. Adjusting optotypes from console**

**By IR**

1 It is possible to generate optotypes from console by pressing on    of the keyboard of the console.

2 Then, click on .

> The following page appears.

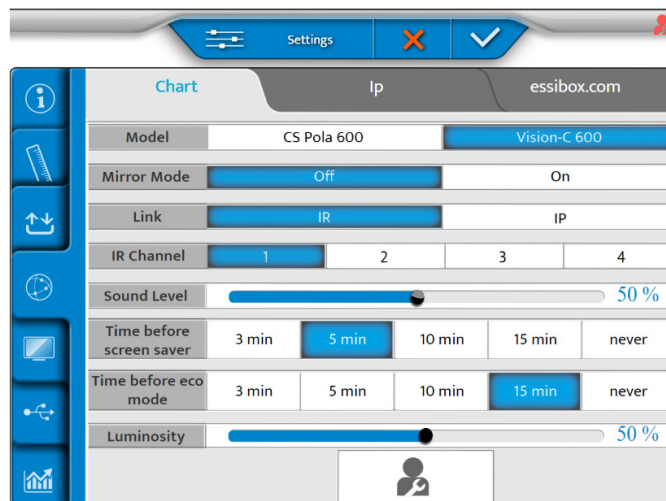

3 Set the mirror mode [OFF] or [ON] regarding your configuration.

- 4 Then, click on .
- > The following page appears.

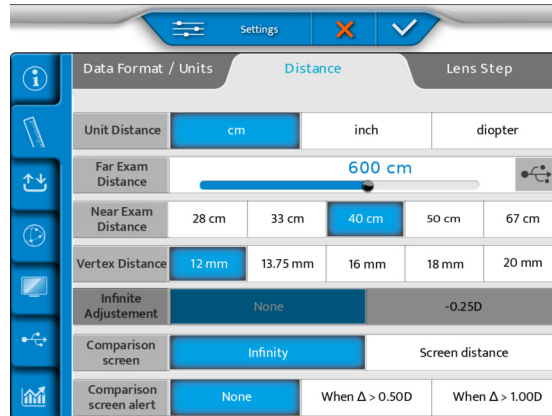

- 5 Set the visual acuity:
- o cm
  - o inch
  - o diopter
- 6 And, set the distance from phoropter head to the screen in [Far Exam Distance] menu.
- 7 Insert a USB key on the side of the console or, directly on the power supply.



- 8 Select  on the screen.



9 Press on  to confirm.

> The process starts.

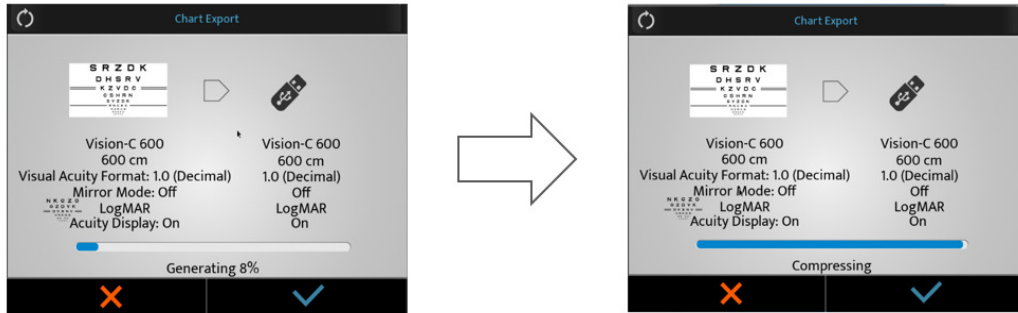

> A warning popup appears.

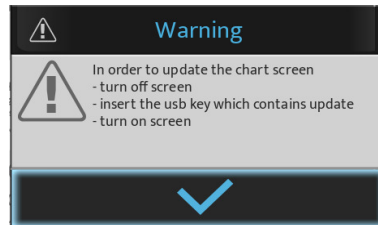

> Press on  to confirm.

> The optotypes are adjusted.

10 Then, connect the USB key on one of the USB port of the chart screen.

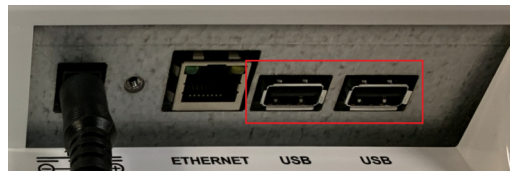

11 Switch on the screen.

> The update will start automatically.

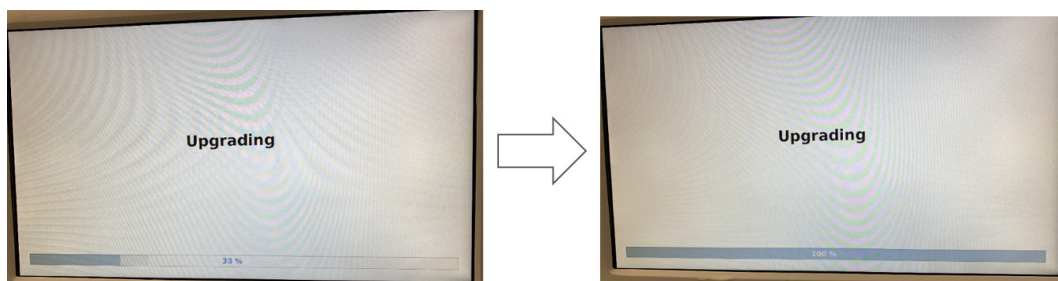



12 Remove the USB key.



> The chart screen will restart automatically.



By IP (LAN)

1 It is possible to generate optotypes from console by pressing on  >  of the keyboard of the console.

2 Then, click on .

> The following page appears.

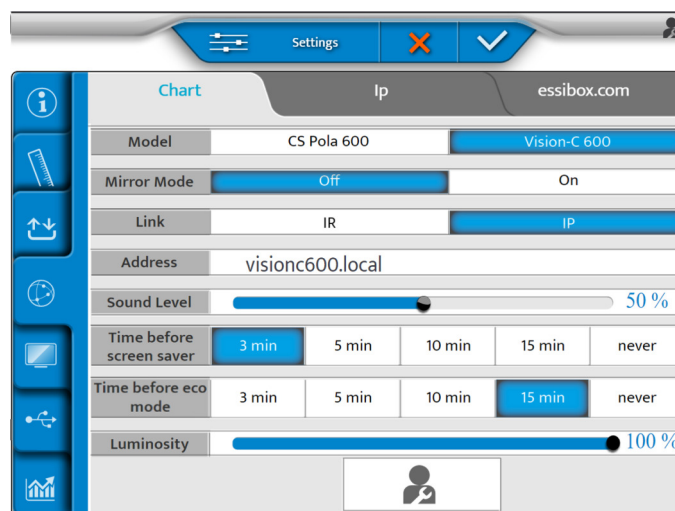

3 Set the mirror mode [OFF] or [ON] regarding your configuration.

- 4 Then, click on .  
> The following page appears.

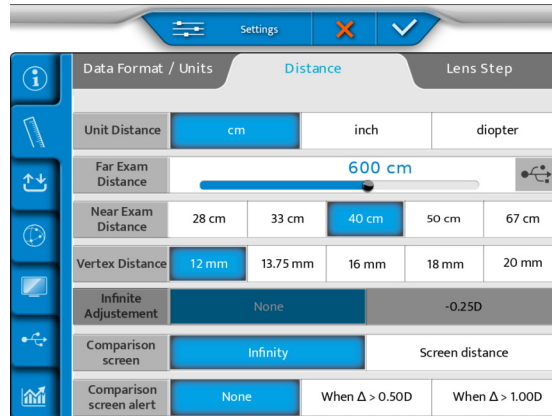

- 5 Set the visual acuity:
- o cm
  - o inch
  - o diopter
- 6 And, set the distance from phoropter head to the screen in [Far Exam Distance] menu.
- 7 Select  on the screen.



- 8 Press on  to start the update.



- > The Vision-600 is downloading and upgrading the software.

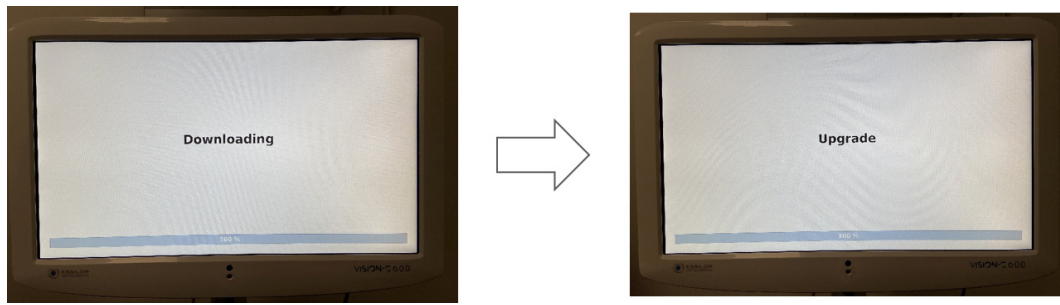

- > Then, the system reboots.



- > The message [Waiting chart screen] appears on the keyboard.

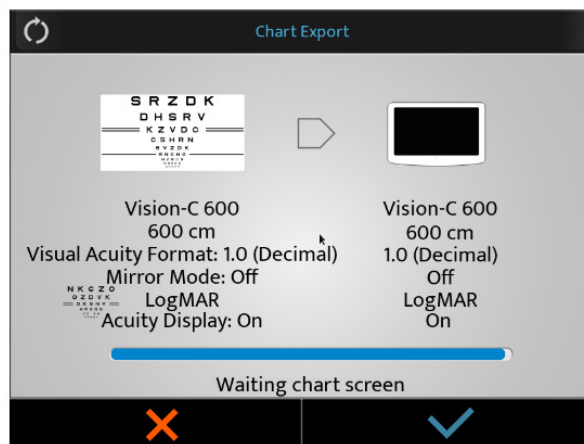

- 9 Don't do anything.
  - > The system reboots a second time.

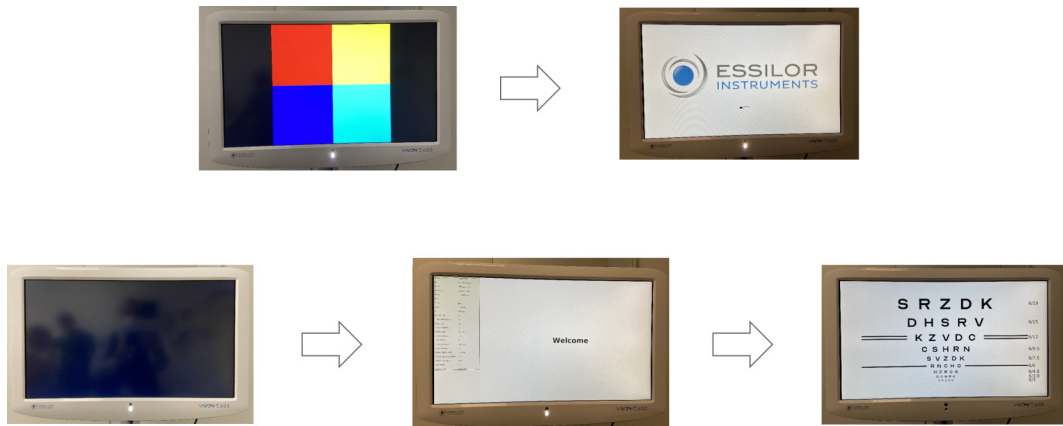

- 10 At the end of the update press on .



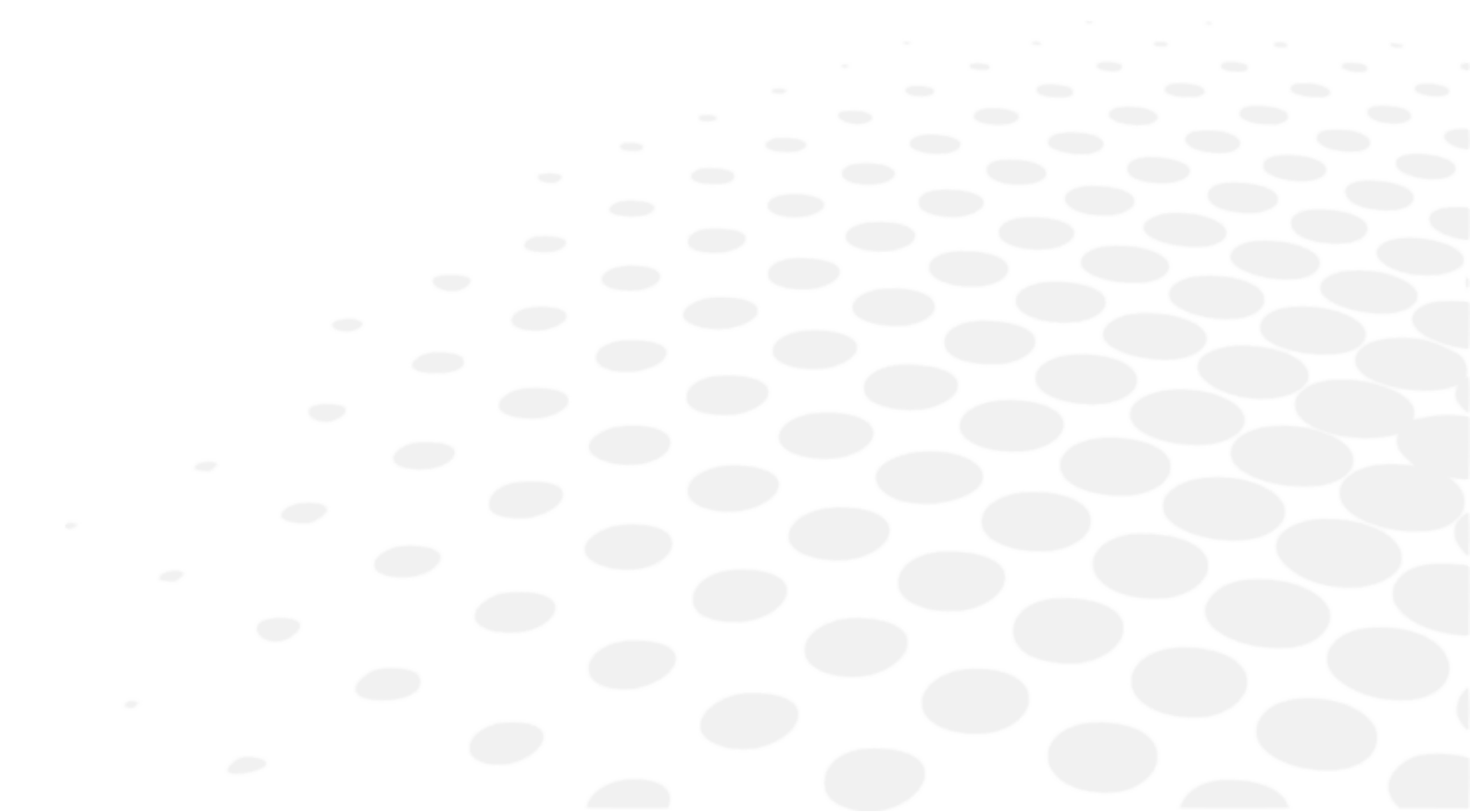

## **VI. UPDATE THE SCREEN**





The Vision-C 600's update is managed by the Vision-R 700 & Vision-R 800.

When a new memory of the Vision-R 700 & Vision-R 800 is available, it is including the one of the Vision-C 600.

## 1. Update by USB key

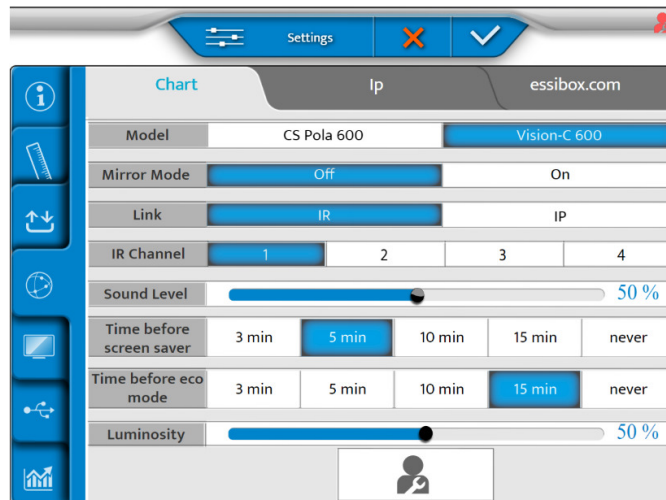
- 1 Click on  >  of the console.
  - 2 Then click on .
- > The following page appears:



- 3 Set the [Link] setting with [IR].
  - 4 Then, click on .
- > The following page appears.

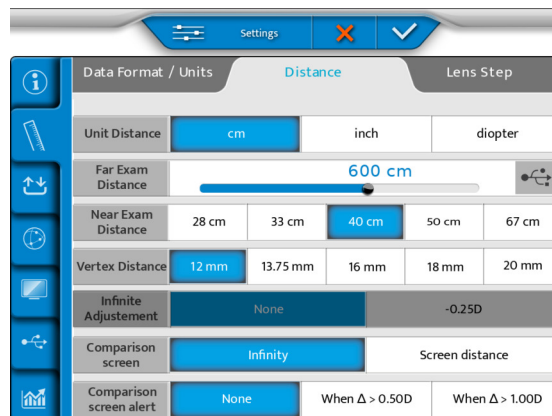

- 5 Insert a USB key on the side of the console or, directly on the power supply.

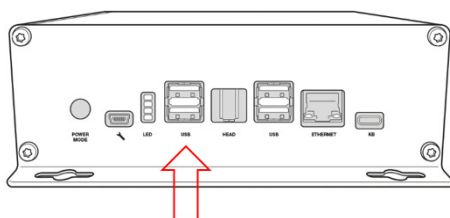

- 6 Select  on the screen.

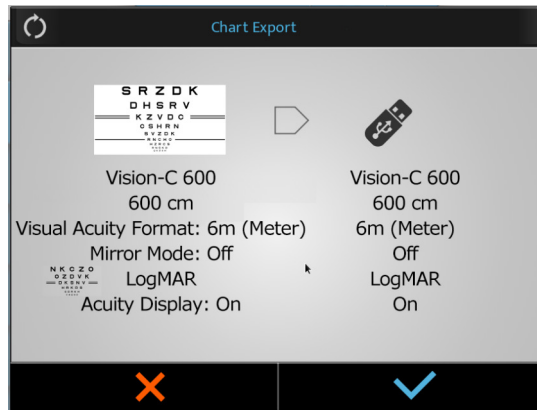

- 7 Press on  to confirm.

> The process starts.

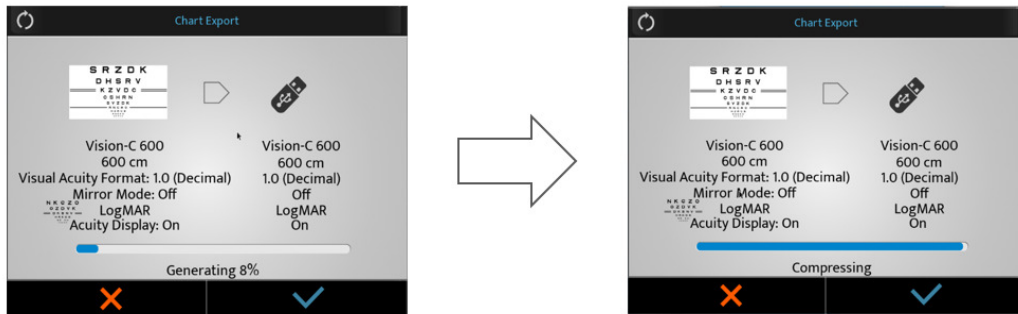

> A warning popup appears.

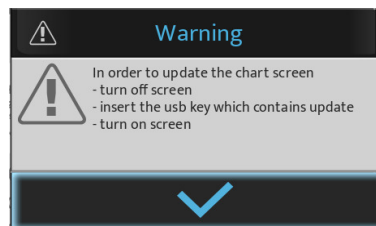

> Press on  to confirm.

> The optotypes are adjusted.

- 8 Connect the USB key on one of the USB port of the chart screen.

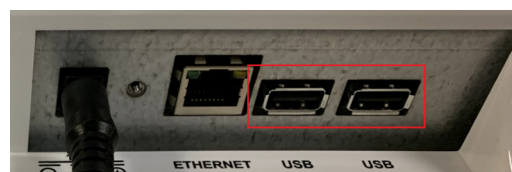

- 9 Switch on the screen.
  - > The update will start automatically.





- 10 Remove the USB key.





- > The chart screen will restart automatically.

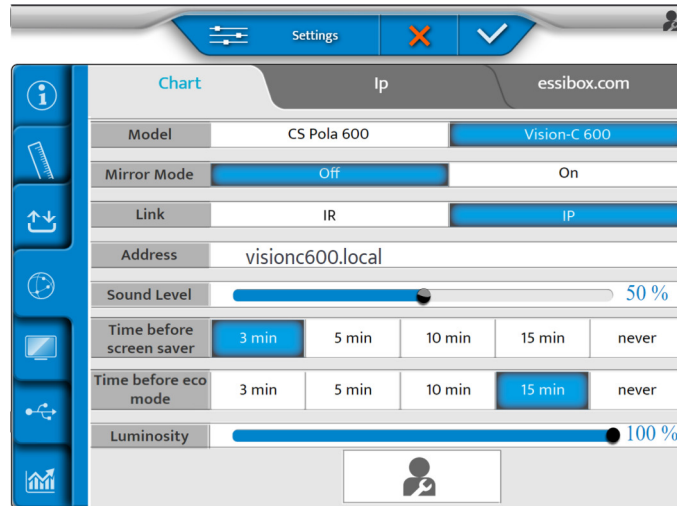

## 2. By LAN (IP)

- 1 Click on  >  of the console.
  - 2 Then click on .
- > The following page appears:



- 3 Set the [Link] setting with [IP].
  - 4 Then, click on .
- > The following page appears.

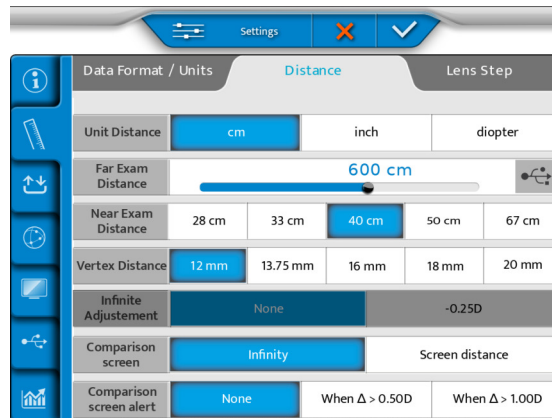

5 Select  on the screen.

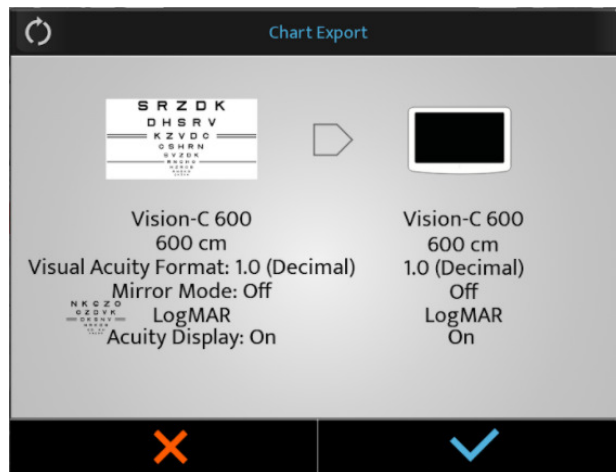

6 Press on  to start the update.

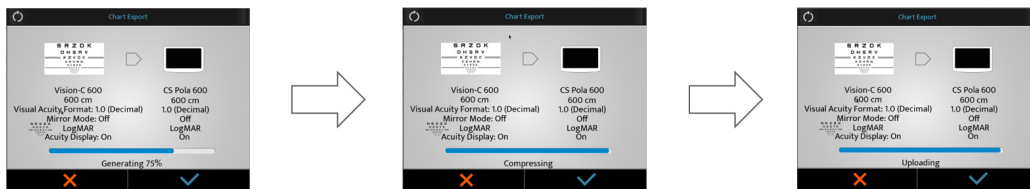

> The Vision-C 600 is downloading and upgrading the software.



> Then, the system reboots.



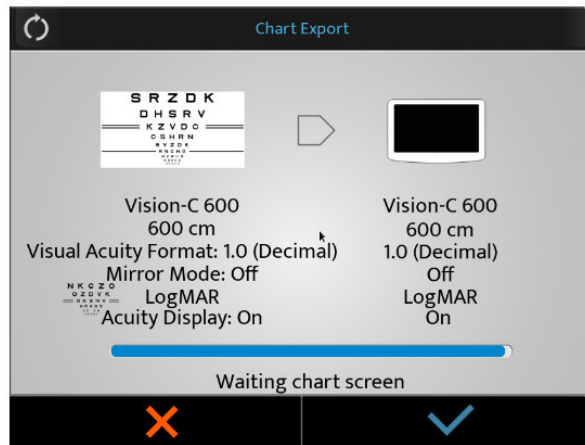

> The message [Waiting chart screen] appears on the keyboard.

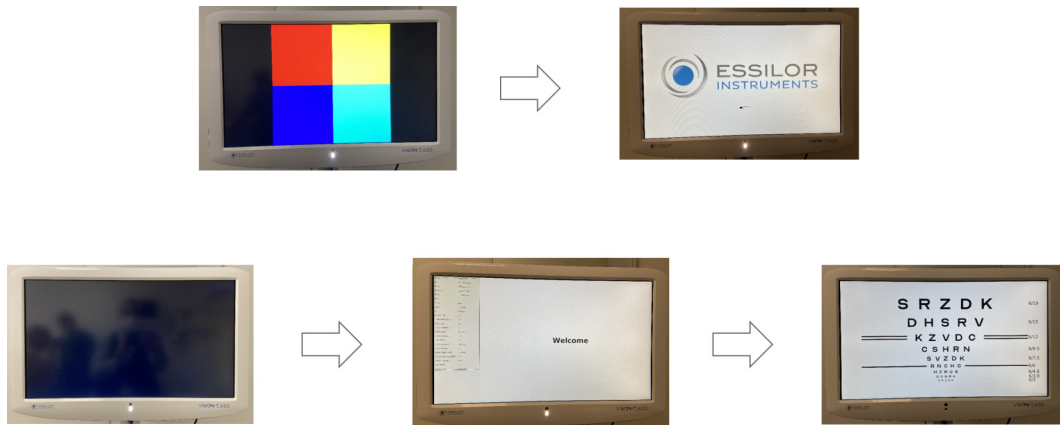

7 Don't do anything.

> The system reboots a second time.



8 At the end of the update press on .

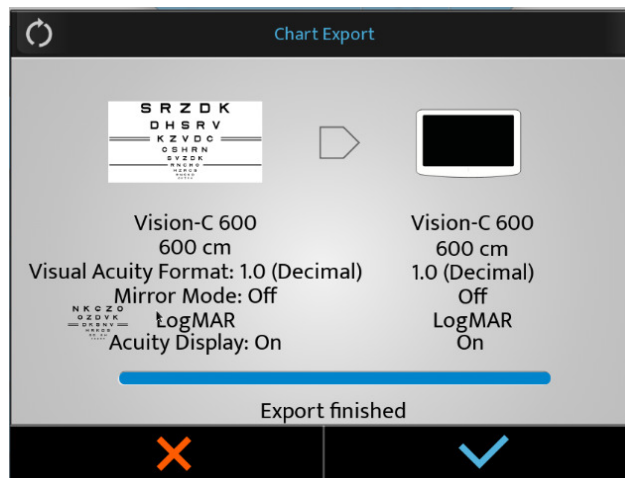

# VII. ERROR DISPLAY

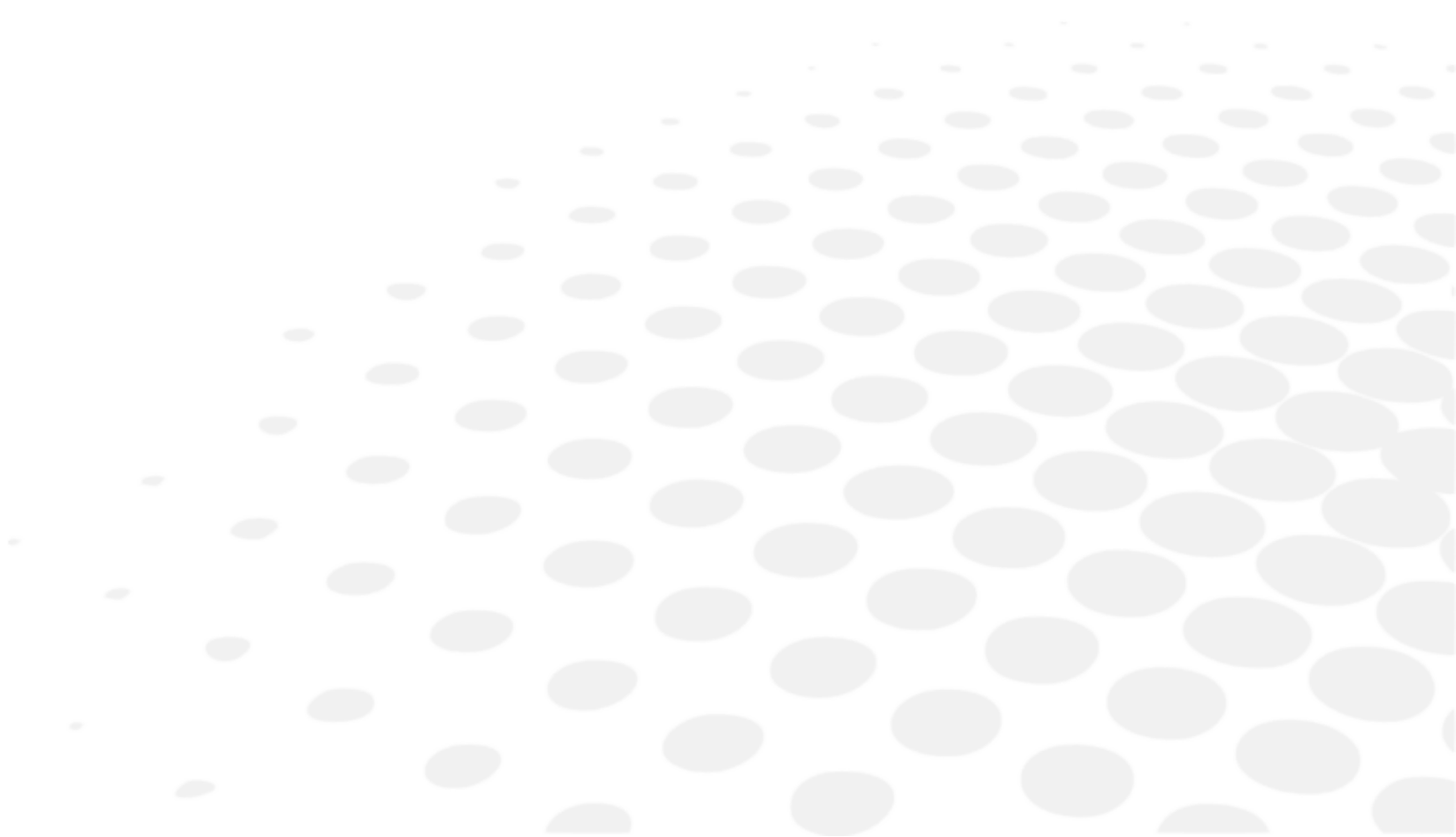

This section is not applicable.

## **VIII. SAFETY CONSIDERATION**

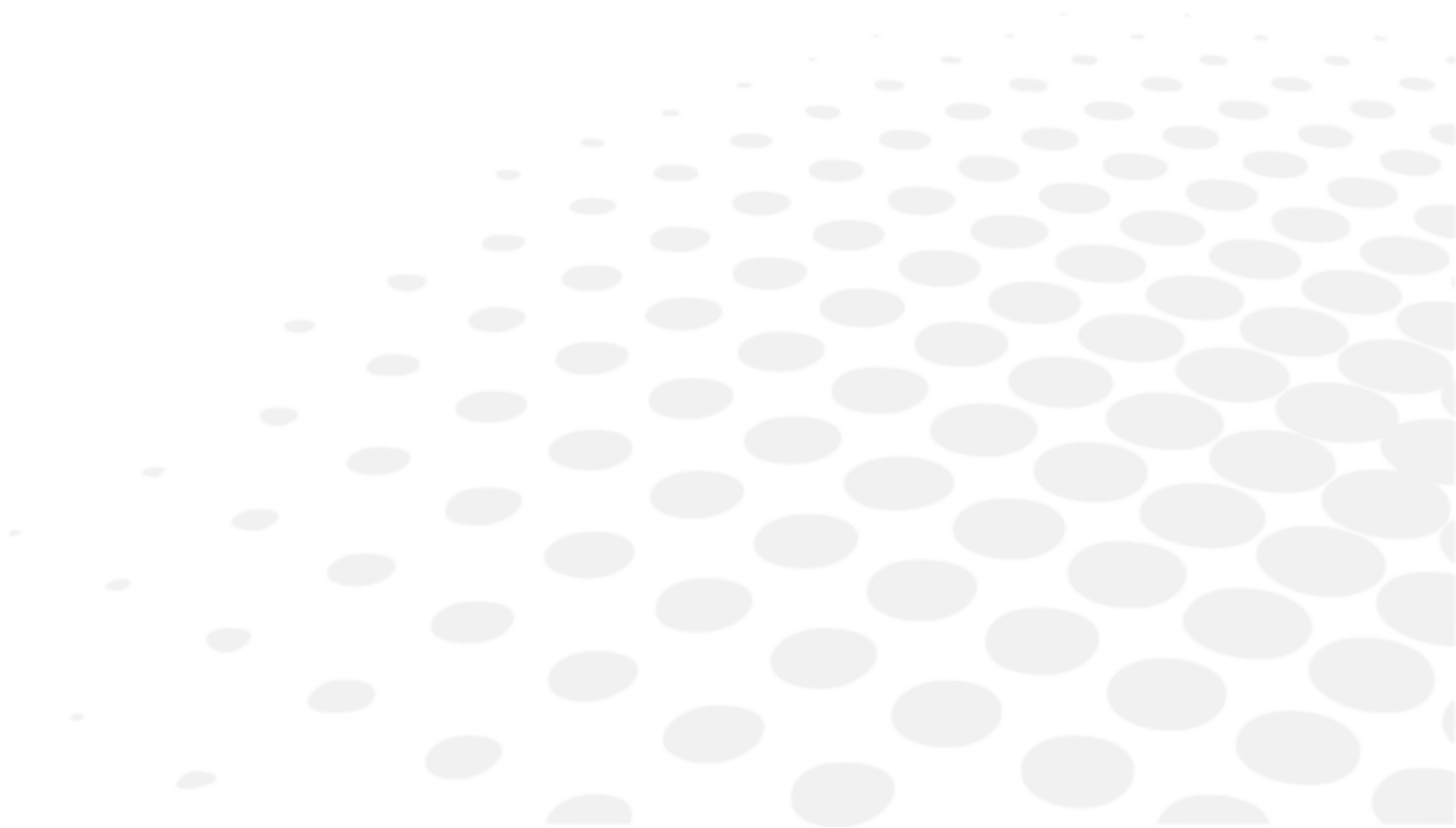





Any serious incident that has occurred in relation to the device should be reported to the manufacturer and the competent authority of the Member State in which the user and/or patient is established.

Vision-C 600 is a class I medical device (Regulation (EU) 2017/745).













Basic UDI of the device: 361502VISIONC600









## 1. Symbols (device & packaging)

### a. On the document

SYMBOL	DESCRIPTION
	Caution: a hazardous situation that, if not avoided, could result in minor or moderate injury.
	Warning: a hazardous situation that, if not avoided, could result in death or serious injury.
	Danger: a hazardous situation that, if not avoided, will result in death or serious injury.
	Important and/or useful additional information to learn relating to the text in this manual.
	Tips: practical advice.

### b. On the device and packaging

SYMBOL	DESCRIPTION
	Obligation to refer to the operating manual
	Alternate current
	D.C. current
	Manufacturer
	Manufacturing date (year)
	CE Marking (European regulation relating to medical devices).
	Medical device
	Consult instructions for use or consult electronic instructions for use.
	Protective earth (ground). (This device is a Class 1 electromedical equipment with galvanic isolation.)
	Polarity
	Compliant to FCC standards
	Waste disposal symbol in accordance with Directives 2012/19/EU and 2011/65/EU
	ON = Turned-on (power supply connected to the mains)

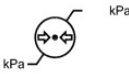
	OFF = Turned-off (power supply disconnected to the mains)
	Handle with care
	This way up
	Maximum stacking of 1 products above market product
	Fragile
	Keep dry
	CE Marking (European regulation relating to medical devices).
	Indicate the thermal limits to which the medical device can be exposed in complete safety.
	Indicate the humidity limits to which the medical device can be exposed in complete safety.
	Indicate the limits of atmospheric pressure to which the medical device can be exposed in complete safety.

## 2. Precautions for use



- Essential performances: From regulatory stand point, the product has no essential performance.
- Do not install the instrument next to wireless devices (TV, radio, etc.). The instrument may cause interference.
- Never attempt to dismantle the instrument. This may cause a malfunction or fire.
- If the instrument does not work properly, do not touch the inside. Disconnect the plug from the outlet and consult your dealer.
- If liquid spills onto the instrument or foreign objects get inside, unplug the plug from the outlet and consult your dealer.
- If any abnormalities occur (noise, smoke, etc.), unplug the plug from the outlet and consult your dealer. Continued use may result in fire or personal injury.
- The presence of fingerprints or dust on the optical parts, for example on the observation windows, affects the accuracy of measurements. It is therefore recommended not to handle them with your fingers and to keep them away from dust. If there are fingerprints or dust on the optical parts, gently wipe them with a soft cloth.
- The covers are fragile, handling them while wearing jewelery or having long nails can lead to scratches.
- The white covers may yellow over time when exposed to ultraviolet light for an extended period.
- There is no limit conditions that the device can tolerate.



- Do not try to repair or modify the instrument.
- Never try to perform any repairs inside the instrument yourself. In the event of malfunctions, consult your dealer.
- To avoid any risk of electrocution, do not open the cover. Consult your dealer for all repairs.

## 3. Contraindication

No contraindications.

## 4. Side effects

No undesirable side-effects.

## 5. Exclusion of liability clause



- The results and/or technical data resulting from the handling or use of instruments must be analyzed by professionals experienced in various fields of application of the instrument in order to avoid any risk of misreading or incorrect analysis of the data.
- Diagnostics are carried out under the responsibility of the user and Essilor declines any responsibility for the results of these diagnostics.
- Each instrument constructed, marketed and/or put on the market directly and/or indirectly by Essilor is designed according to the provisions and the regulations in force. It contains the necessary information to ensure the intended use and permitting the identification of the manufacturer, taking into account the training, experience and knowledge of the intended user.
- This information, including that contained in the accompanying product manuals and the technical advice provided, whether oral, written or communicated during a demonstration, is provided on the basis of best knowledge. However, it must be considered as information without any binding effect, including third-party industrial property rights. It does not exempt the customer from checking current versions, communicated advice and suggestions, particularly the technical safety data sheets, instructions and technical information, as well as assessing the capacity of the instruments to ensure the intended use during delivery.
- The application, use and handling of these instruments as well as the products developed by the customer on the basis of technical consulting and/or maintenance activities are not under the control of Essilor. They are therefore the sole responsibility of the customer. Essilor declines any responsibility in the matter, as indicated below.
- The sale of products is governed by the general conditions of sale and delivery as modified.

## 6. Power source



- **WARNING:** To avoid the risk of electric shock this device must only be connected to a supply mains with protective earth.
- Take care to use the power cord grounding cable when connecting to the ground terminal.
- Do not damage the power cord (by bending it, pulling it or placing heavy objects on top of it, etc.). Do not modify it either. If the cord is damaged (loose contact, damaged sheath, etc.), replace it with a new cord. Continued use may result in an electric shock or fire.
- Do not touch the power plug with wet hands. This may cause an electric shock.
- If you do not use the instrument for an extended period, disconnect the power cord from the outlet.



- Do not use multi-socket power strips, adapters or extension cords to connect the instrument to the mains.
- Make sure the power cord is fully inserted into both the plug and the instrument. Failure to insert it properly may result in a fire or electric shock.
- Clean the power cord regularly to avoid dust buildup. If the cord is dirty, it may cause a malfunction or fire.
- If the power cord becomes hot after using the instrument, check that it is not dirty. If it is not, replace the power cord with a new one. Continued use may cause malfunction or personal injury.
- Use the instrument with the appropriate supply voltage. Continued use with a supply voltage greater than the rated power may cause malfunction or fire.
- Hold the plug when you insert or remove the power cord.
- Use only the power cord provided with the device, model H05VV-F cord type 3G 10 mm<sup>2</sup>, provided with VIIG plug. SJT 3x18 AWG provided with hospital grade plug Nema 5-15P HF for US/CAN ; 2 m in length.

## 7. Precautions regarding IT Network



- This instrument can transfer data to a computer or other devices via a USB or RJ45 interface. These devices must comply with the standard IEC 62368-1. Purpose is to refraction data.
  - IT Network must be parametered in order to accept the text file from product address (firewall parameters)
  - Transfer routines are compliant with FTP protocols.
  - No hazardous situation was reported through product design risk analysis.
  - External equipment intended for connection to signal outputs on the device shall comply with the relevant product standard for such equipment IEC 62368-1 for IT-equipment. In addition, all such combinations – Medical Electrical Systems – shall comply with the requirements stated in clause 16 of IEC 60601-1. Any equipment not complying with the leakage current requirements in IEC 60601-1 shall be kept outside the patient environment (at least 1.5 m from the patient support or shall be supplied via a Separation transformer to reduce the leakage currents).
- Any person who connects external equipment to the device has formed a Medical Electrical System and is therefore responsible for the system to comply with the requirements in clause 16 of IEC 60601-1. If in doubt, contact qualified medical technician or your local representative.
- A Separation Device (isolation device) is needed to isolate the equipment located outside the patient environment from the equipment located inside the patient environment. In particular such a Separation Device is required when a network connection is made. The requirement for the Separation Device is defined in clause 16.5 of IEC 60601-1.
- Connecting this instrument to a computer network that includes other equipment may result in safety and data protection risks.
- The responsible organization is expected to identify, analyze, evaluate and control these risks.
- Any subsequent changes to the computer network may cause risks and require further analysis.
- These changes include:
  - changing the configuration of the computer network;
  - connection of additional devices to the computer network,
  - disconnection of elements of the computer network,
  - updating the equipment connected to the computer network;
  - upgrading the equipment connected to the computer network.

Please contact your distributor for detailed information on this instrument.

## 8. Electromagnetic compatibility



All of the information listed below is based on normative requirements to which manufacturers of electro-medical devices are subject, as defined in the IEC60601-1-2 Ed4 standard.

The device complies with the applicable electromagnetic compatibility standards, however, the user must ensure that any electromagnetic interference does not create an additional risk, such as radio frequency transmitters or other electronic devices.

In this chapter you will find information necessary to ensure that your device is installed and put into service in the best conditions in terms of electromagnetic compatibility. The device's different cords must be separated from each other.

Certain types of mobile telecommunications devices such as mobile phones may interfere with the device. Recommended separation distances must therefore be respected.

The device shall not be used in the vicinity of or placed on another device. If this cannot be avoided, it is necessary to check its proper functioning under the conditions of use before using it. The use of accessories other than those specified or sold by the manufacturer as replacement parts may result in an emissions increase or a decrease in the immunity of the device.

In case the device stop working, reset the device, restart test from the beginning, do not use the previous data for make prescription.

**a. Length of cables, cords, etc.**



The length of cables or cords must be greater than 3 meters.

TYPE OF TEST	IN ACCORDANCE WITH
RF emission	CISPR 11, Class A
Harmonic current emission	IEC 61000-3-2
Voltage fluctuations and flickering	IEC 61000-3-2
Immunity to electrostatic discharge	IEC 61000-4-2
Radiated Immunity - Electromagnetic Fields	IEC 61000-4-3
Immune to electrical fast transients and bursts	IEC 61000-4-4
Shock-wave immunity	IEC 61000-4-5
Conducted radio frequency disturbance immunity	IEC 61000-4-6
Radiated Immunity - Magnetic Fields	IEC 61000-4-8
Immunity to voltage dips, brief cuts and voltage variations	IEC 61000-4-11

**b. Recommended separation distance**



The device is intended for use in a electromagnetic environment in which RF radiation disturbances are controlled.

The user or installer of the device can help avoid electromagnetic interference by maintaining a minimum distance, depending on the maximum power of the radio frequency transmission equipment. Portable RF communications devices (including devices such as antenna cables and external antennas) must not be used closer than 30 cm (12 inches) to any part of the device, including cables specified by the manufacturer. Otherwise, the performance of these devices could be affected.

**c. Electromagnetic emissions**



This product is intended for use in the electromagnetic environment specified below. It is up to the customer or the user to verify that the instrument is used in this environment.

EMISSIONS TEST	COMPLIANCE	ELECTROMAGNETIC ENVIRONMENT – GUIDELINES
Electromagnetic radiation disturbance (Radiated Emissions) (CISPR 11)	Group 1	The product uses RF energy for internal functions.
Disruptive voltage at power stations (Conducted emissions) (CISPR 11)	Class B	The product may be used in all establishments, including domestic sites and those connected directly to the public low-voltage power.
Harmonic current emission (IEC61000-3-2)	Class A Complies	
Voltage variations, voltage fluctuations and flicker (IEC61000-3-3)	Complies	

**d. Magnetic and electromagnetic immunity**



The product is intended for use in the electromagnetic environment specified below. It is up to the customer or the user to verify that the instrument is used in this environment.

IMMUNITY TEST	TEST LEVEL IEC 60601 & COMPLIANCE LEVEL	ELECTROMAGNETIC ENVIRONMENT – GUIDELINES
Electrostatic discharge (ESD) (IEC61000-4-2)	± 8 kV contact ± 15 kV air	Environment of a professional healthcare facility.
Electrical fast transients and bursts (IEC61000-4-4)	± 2 kV for power supply lines ± 1 kV for the signal ports	
Shock Waves (IEC61000-4-5)	± 2 kV in differential mode ± 1 kV in current mode	

Assigned industrial frequency magnetic field (IEC61000-4-8)	30 A/m	
Voltage dips, short interruptions and voltage variations (IEC61000-4-11)	0% $U_T$ for 0.5 cycles (0°, 45°, 90°, 135°, 180°, 225°, 270° and 315° for 0.5 cycle) 0% $U_T$ for 1 cycle 70% $U_T$ For 25 cycles at 50 Hz For 30 cycles at 60 Hz Single phase: 0°	Environment of a professional healthcare facility. If using the system requires continued operation during power cuts, it is recommended that the medical device be supplied with a separate power source (UPS, etc.).
Voltage Interruptions (IEC61000-4-11)	0% $U_T$ for 250 cycles at 50Hz for 300 cycles at 60Hz	



$U_T$  is the AC mains voltage before applying the test level.

### e. Electromagnetic immunity, radio frequencies



The product is intended for use in the electromagnetic environment specified below. It is up to the customer or the user to verify that the instrument is used in this environment.

Portable RF communications devices (including devices such as antenna cables and external antennas) should not be used closer than 30 cm (12 inches) to any part of the device under test, including cables specified by the manufacturer. Otherwise, the performance of these devices could be affected.

IMMUNITY TEST	TEST LEVEL IEC 60601 & COMPLIANCE LEVEL	ELECTROMAGNETIC ENVIRONMENT – GUIDELINES
Electromagnetic fields radiated radio frequency (IEC61000-4-3)	3 V/m 80 MHz to 2.7 GHz 80% MA at 1 kHz	Occupational healthcare facility.
Proximity Fields emitted by RF Wireless Communications Devices (IEC 61000-4-3 Interim Method)	V/m 710 MHz, 745 MHz, 780 MHz, 5240 MHz, 5550 MHz, 5785 MHz, 27 V/m 385 MHz 28 V/m 450 MHz, 810 MHz, 870 MHz, 930 MHz, 1720 MHz, 1845 MHz, 1970 MHz, 2450 MHz,	
Field-induced conducted disruptions RF (IEC610004-6)	3 V 150 Khz to 80 MHZ 6 V in ISM frequency and band between 0.15 MHz and 80 MHz, amateur radio frequency including 80% MA at 1 KHz	

## **IX. TROUBLESHOOTING**

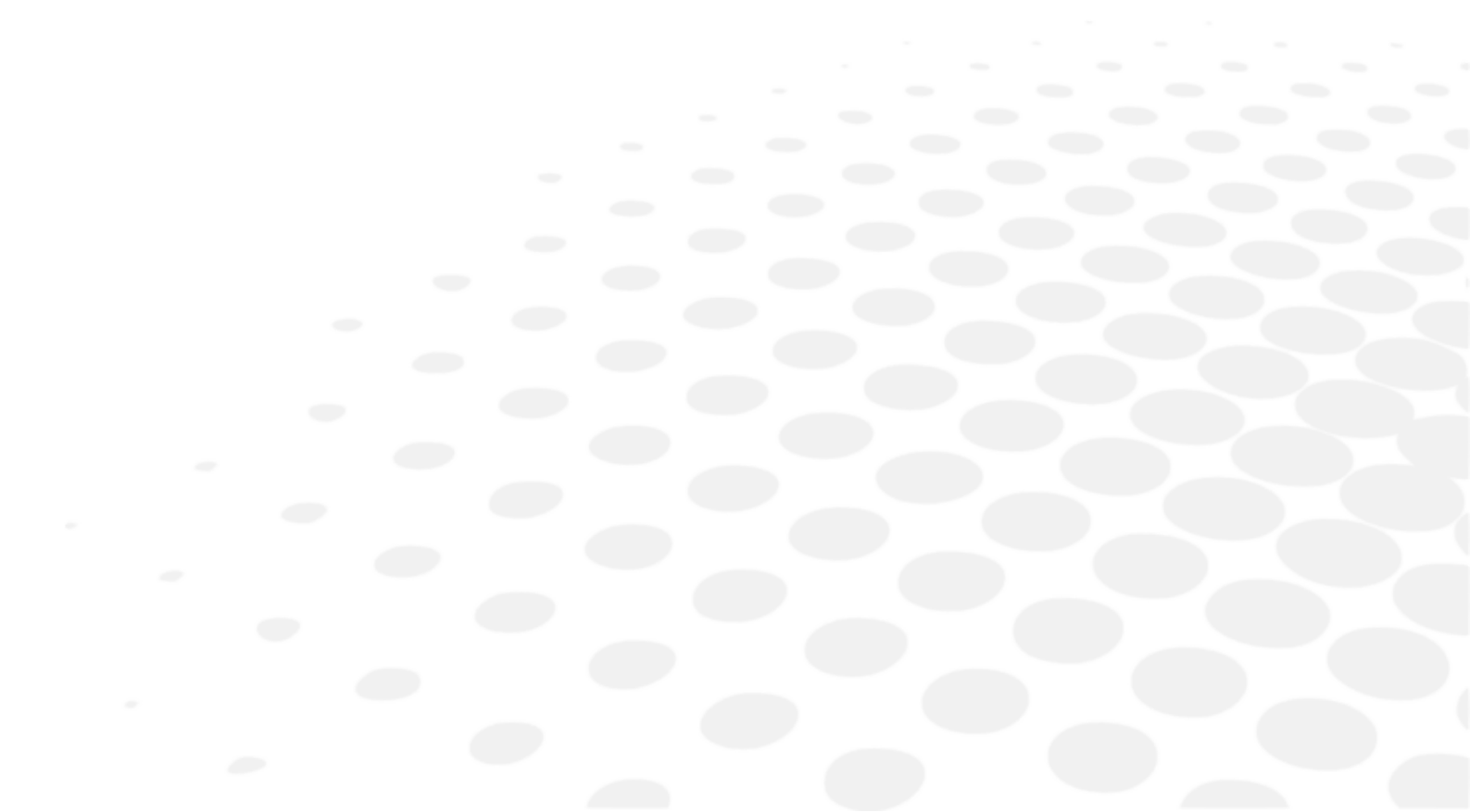

If a problem is detected, refer to the table below in order to take the appropriate measures.

SYMPTOMS	CAUSES AND MEASUREMENTS
Product doesn't turn ON	<ul style="list-style-type: none"> <li>• Power cable not plugged in. &gt; Plug shall be into power outlet.</li> </ul>
Wrong SD card mounting	<ul style="list-style-type: none"> <li>• Screen remains black at start-up. &gt; Open the product and open the cover to access the main board. &gt; In the SD card location, remove it and put it back so that the card touches the pins. &gt; Restart the product and, in the case that it starts replace all the covers back on. &gt; If the product does not turn on contact your local technical support.</li> </ul>

If the problem has not been resolved after taking the measures listed above, contact your local distributor immediately.  
 Your dealer has been trained by Essilor.



Please refer to the name plate and let us have the following information:

- Name of the instrument: VISION-C 600
- Serial number: 9 digit-characters indicated on the name plate
- Detailed defects

# X. MAINTENANCE

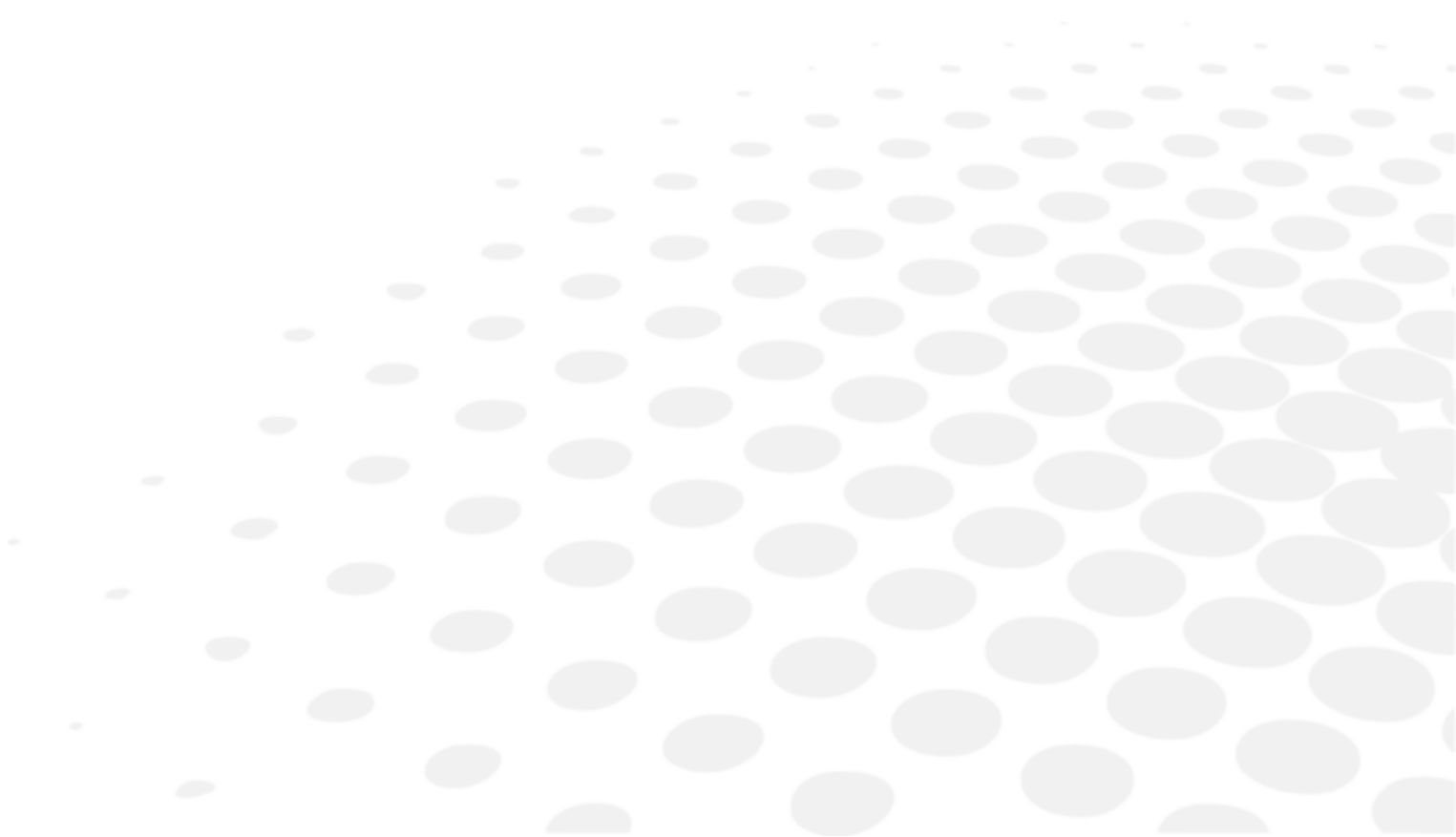



- In order to ensure safety and the performance of the instrument, all maintenance operations, unless otherwise specified in this manual, must be carried out by qualified maintenance technicians.
- This instrument is a high precision optical device. Handle it carefully at all times.
- Do not touch the screen with your fingers, and take care to clean off any dust buildup which would be likely to distort the optotypes display.
- If you find that this device is dirty, you can clean it as often as you want (see after the specific cleaning methods).

## 1. Storage and handling condition



Respect the operating, storage and transport conditions noted below.  
Avoid condensation conditions.

	Temperature	Humidity	Atmospheric pressure
Use	[+15°C; +30°C]	[30 %; 90 %]	[800 hPA; 1060 hPA]
Storage	[- 10°C; + 55°C]	[10 %; 95 %]	[700 hPA; 1060 hPA]
Transport	[- 40°C; + 70°C]	[10 %; 95 %]	[700 hPA; 1060 hPA]

## 2. Cleaning



To avoid any incident, unplug the instrument before cleaning.



- Always use a slightly damp soft cloth (microfiber, silicone), to clean the instrument.
- Do not spray liquid on the screen or other parts of the product, regardless of the liquid, in order not to risk damaging the electronic boards.
- Do not use benzene, thinners, organic solvents, ether or gasoline to clean the instrument.

Essilor will make available on request circuit diagrams, component part lists, descriptions, calibration instructions, or other information that will assist the dealer to repair those parts of this device that are designated by ESSILOR as repairable by the dealer.

## 3. Periodical inspection and maintenance



Inspect the instrument (once a week) to ensure that it is correctly fixed to the wall.

If there are any problems with the product, please follow the following steps.

1. Turn OFF the power.
2. Remove the power cable connected to the equipment.
3. Connect power adapter to the equipment and turn ON the power.
4. Check if the power led is green,
5. Check if the equipment operates properly with Vision-R keyboard (see chapter [Adjustments before the examination]),
6. If the equipment does not operate properly, you are recommended to do as below.

Check model name and serial number of the equipment and contact your Essilor contact immediately.

This product may malfunction due to the electromagnetic waves caused by cell phones, transceivers, radio-controlled toys, etc. Be sure to avoid having objects such as, which affect this product brought near product.

## 4. Disassembly of the product and transport

This section is not applicable.

## 5. Disposal



Instructions for the disposal of the instrument in accordance with Directives 2012/19/EU and 2011/65/EU regarding the limitation of dangerous substances in electrical and electronic equipment and the disposal of electrical and electronic waste.

When it reaches the end of its lifetime, the instrument should not be thrown out with the household refuse. It can be disposed of at a waste management center operated by the municipality or the retailers who offer this service.

The separate disposal of an electrical device avoids any damage to the environment or health that could result from a non-compliant disposal, and also allows the materials it is composed of to be recycled in order to save energy and resources.

The pictogram of the wheeled container appears on the label of the instrument. It indicates the obligation for separate collection and disposal of end-of-life/out-of-use electrical and electronic equipment.



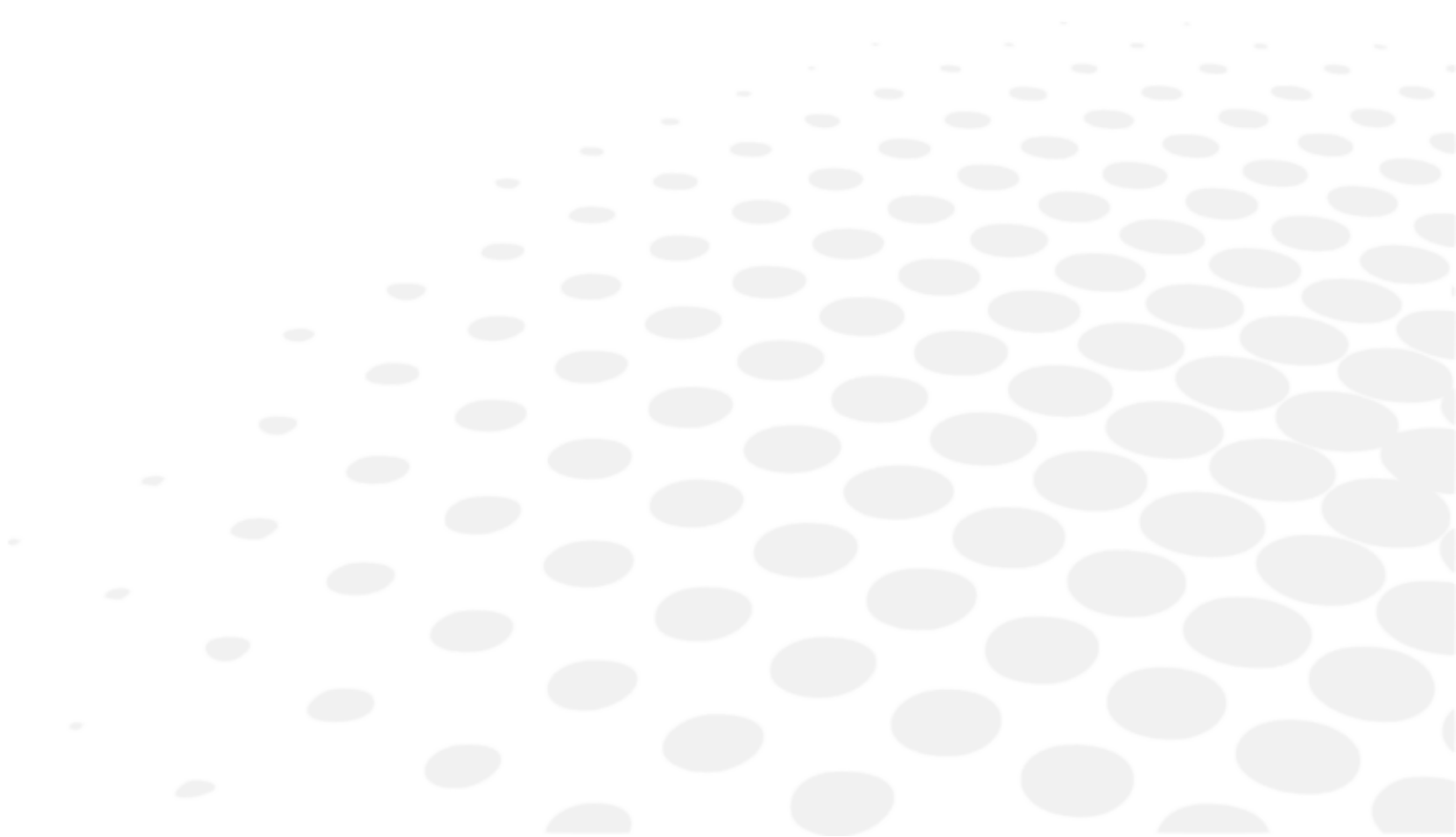

- The user must take into account the potentially harmful effects on the environment and human health that could result from the non-compliant disposal of the instrument in its entirety or some of its components.
- To avoid the release of dangerous substances into the environment and to encourage the preservation of natural resources, the manufacturer facilitates, in the event that the user wishes to dispose of the instrument at the end of its lifespan, the reuse, recovery and recycling of the instrument and its components. Before disposing of the instrument, the requirements of European and national regulations must be taken into consideration.
- Do not dispose of the instrument with household waste, but dispose of it separately by giving it in a company specialized in the disposal of electrical and electronic equipment or at the local administrative services in charge of waste collection.
- The supplier or manufacturer is required to recover the old equipment.
- By joining a consortium for the waste of technological equipment, the manufacturer covers the treatment and recycling costs of the used instrument.
- The manufacturer undertakes to provide the user with all the information relating to the dangerous substances contained in the device and the methods of recycling these substances, and to inform them of the existence of recycling of the used equipment. The law provides for severe penalties in case of infringement.

# XI. SPECIFICATIONS



## 1. Technical data

The expected life of the device and its components is 7 years.

- LCD type: 24 Inch IVO TFT LCD / optical polarizing glass type
- Resolution: 1920 x 1080 pixels
- Chart window size:
  - Length: 293.2 mm
  - Width: 521.3 mm
- Brightness: Max 250 cd / m<sup>2</sup>
- View distance: 3 m ~ 8 m (0.25 step adjustment)
- Memory card: SD card (8 GB)
- Audio output: Mono 4W Max
- Power source:
  - 100 - 240 V  50/60Hz
  - 12V  5A (power adaptor)
  - Model: GSM60A12-P1J
- Power consumption: Less than 60VA
- Communication:
  - Wire: Ethernet
  - Wireless: IR DA Communication

### a. Dimensions and weight

- Length: 393.6 mm
- Width: 612 mm
- Depth: 71.3 mm
- Total weight: 7.9 Kg

### b. LEDs specifications

- Visible white LED:
  - Color: white
  - Chromaticity CCT: 5000 K
  - Flux: 35.9 lm
  - Class: NC
- Infra-red LED:
  - Color: IR
  - Wavelength: 850 nm
  - Radiant intensity: 1000mW/sr
  - Class: 2

## 2. Connectivity to other devices

This section is not applicable.

## 3. It requirements

This section is not applicable.

## XII. QR CODE

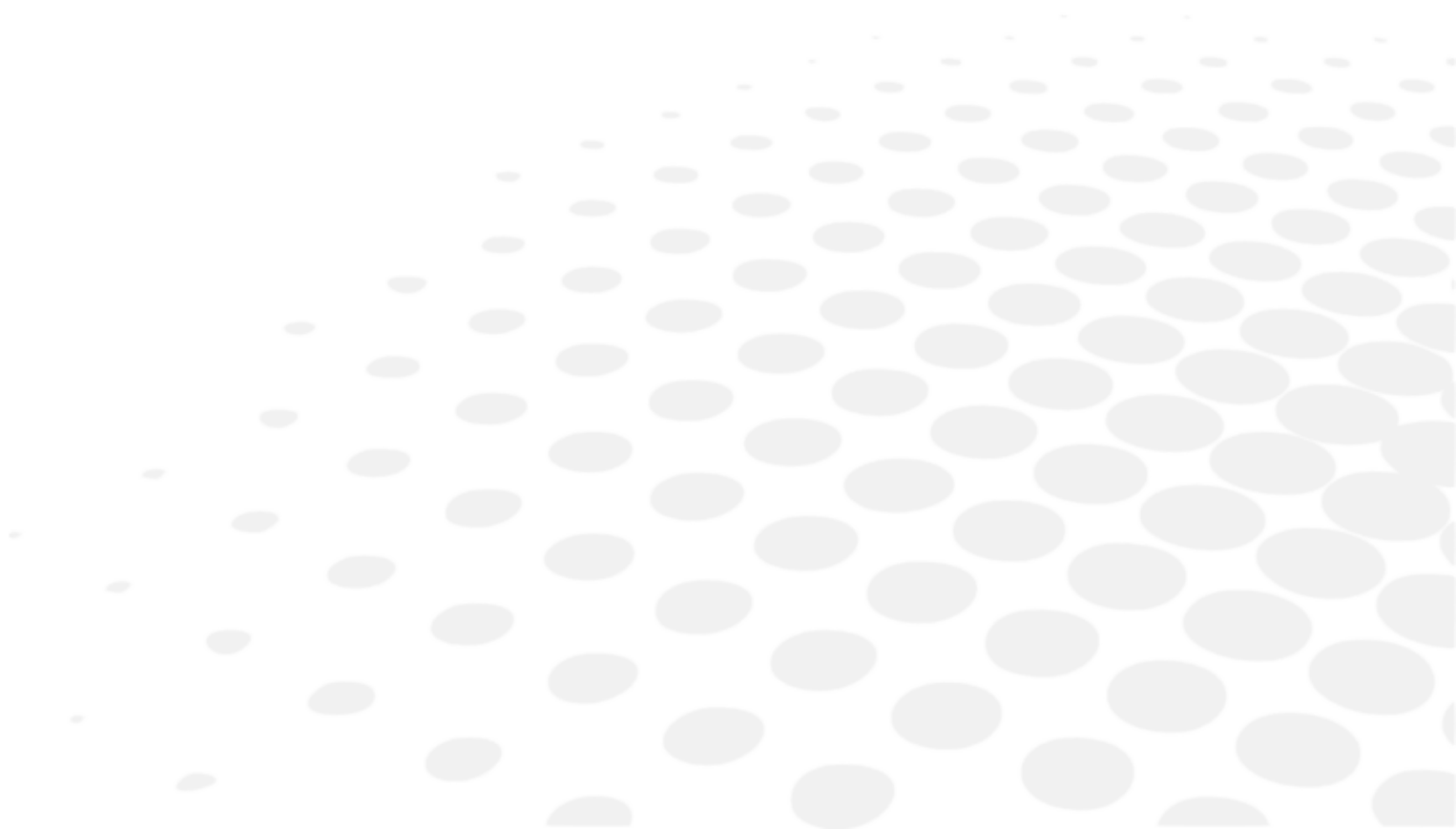

The latest version of the user manual in the appropriate language is available on a web space. Upon request, a paper version can be provided for free.

en The complete user manual is available on a web space in PDF format. To access it, please scan the QR code below using a dedicated tool or application. Please make sure that your device is suitable and has an appropriate software to display the electronic Instructions for use.

fr Le manuel utilisateur complet est disponible sur un espace web au format PDF. Pour y accéder, veuillez scanner le QR code ci-dessous à l'aide d'un outil ou d'une application dédié(e). Veuillez vous assurer que votre appareil est compatible et dispose d'un logiciel approprié pour afficher le manuel électronique.

ar لتتمكن من الوصول إليه، يُرجى مسح رمز الاستجابة السريعة أدناه باستخدام أداة أو تطبيق PDF دليل المستخدم الكامل متوفر من خلال موقع الويب بصيغة مخصص لذلك. يُرجى التأكد من أن جهازك مناسب ويحتوي على برنامج مناسب لعرض التعليمات الإلكترونية الخاصة بالاستخدام.

be Поўная інструкцыя карыстальніка даступна ў інтэрнэт-прасторы у фармаце PDF. Каб атрымаць да яе доступ, адсканіруйце QR-код ніжэй пры дапамозе спецыяльнага сродку або праграмы. Калі ласка, упэўніцеся, што ваша прылада прыдатная для паказу электроннай Інструкцыі па карыстанню і што на ёй усталявана адпаведнае праграмае забеспячэнне.

bg Пълното ръководство за потребителя е достъпно в уеб пространството. За да получите достъп до него, моля, сканирайте QR кода по-долу, като използвате специален инструмент или приложение. Моля, уверете се, че вашето устройство е подходящо и разполага с подходящ софтуер за преглед на електронните Инструкции за употреба.

cs Kompletní uživatelský návod je k dispozici na webovém prostoru ve formátu PDF. Chcete-li k němu získat přístup, naskenujte prosím níže uvedený QR kód pomocí speciálního nástroje nebo aplikace. Ujistěte se prosím, že používáte vhodné zařízení, které má vhodný software pro zobrazení elektronického uživatelského návodu.

da Den komplette brugervejledning er tilgængelig på et webområde i PDF-format. For at få adgang til den skal du scanne QR-koden nedenfor ved hjælp af et dedikeret værktøj eller program. Sørg for, at din enhed er egnet og har en passende software til at vise de elektroniske brugsanvisninger.

de Die vollständige Bedienungsanleitung ist auf einem Webespace im PDF-Format verfügbar. Für den Zugriff scannen Sie bitte den untenstehenden QR-Code mit einem speziellen Tool oder einer Anwendung. Bitte vergewissern Sie sich, dass Ihr Gerät für die Anzeige der elektronischen Gebrauchsanweisungen geeignet ist und über eine entsprechende Software verfügt.

el Το πλήρες εγχειρίδιο χρήσης είναι διαθέσιμο σε έναν ιστοχώρο σε μορφή PDF. Για να αποκτήσετε πρόσβαση σε αυτό, σκανάρετε τον κωδικό QR παρακάτω χρησιμοποιώντας ένα ειδικό εργαλείο ή εφαρμογή. Βεβαιωθείτε ότι η συσκευή σας είναι κατάλληλη και έχει το κατάλληλο λογισμικό για την προβολή των ηλεκτρονικών οδηγιών χρήσης.

es El manual de uso completo está disponible en un espacio web. en formato PDF. Para acceder a él, escanee el código QR debajo utilizando una herramienta o aplicación dedicada. Asegúrese de que su dispositivo sea adecuado y tenga el software apropiado para mostrar las Instrucciones de uso electrónicas.

et Täielik kasutusjuhend on saadaval veebis PDF-vormingus. Juurdepääsuks palun skannige allolevat QR-koodi, kasutades selleks vastavat tööriista või rakendust. Veenduge, et teie seade sobib ja et selles on elektroonilise kasutusjuhendi kuvamiseks sobiv tarkvara.

fi Täysi käyttöopas on saatavana verkosta PDF-muodossa. Saat pääsyn siihen skannaamalla alla olevan QR-koodin käyttäen siihen tarkoitettu työkalua tai sovellusta. Varmista, että laitteesi on sopiva ja sisältää asianmukaisen ohjelmiston sähköisten käyttöohjeiden esittämiseen.

hr Potpun korisnički priručnik dostupan je na mrežnom prostoru u PDF formatu. Da biste mu pristupili, skenirajte QR kod u nastavku pomoću odgovarajućeg alata ili aplikacije. Provjerite je li vaš uređaj prikladan i ima li odgovarajući softver za prikaz elektroničkih uputa za upotrebu.

hu A teljes felhasználói kézikönyv elérhető az interneten PDF formátumban. Eléréséhez olvassa be az alábbi QR-kódot egy erre szolgáló eszközzel vagy alkalmazással. Ellenőrizze, hogy eszköze képes és rendelkezik a megfelelő szoftverrel az elektronikus használati útmutató megjelenítésére.

id	<p>Panduan pengguna lengkap tersedia di ruang web dalam format PDF. Untuk mengaksesnya, silakan pindai kode QR di bawah ini menggunakan alat atau aplikasi khusus. Pastikan peranti Anda sesuai dan memiliki perangkat lunak yang layak untuk menampilkan petunjuk penggunaan elektronik.</p>
it	<p>Il manuale utente completo è disponibile in formato PDF su uno spazio Web. Per accedervi, leggere il codice QR sottostante mediante un apposito strumento o un'applicazione dedicata. Assicursi che il dispositivo sia adatto e che disponga di un software appropriato per visualizzare le istruzioni per l'uso in formato elettronico.</p>
ja	<p>完全なユーザーマニュアルは、PDF形式でウェブスペースから入手できます。アクセスするには、専用のツールまたはアプリケーションを使用して、以下のQRコードをスキャンしてください。お使いのデバイスが適切であり、電子説明書を表示する適切なソフトウェアがインストールされていることを確認してください。</p>
ko	<p>전체 사용 설명서는 웹 공간에 PDF 형식으로 있습니다. 이 설명서에 액세스하려면, 전용 도구 또는 앱을 사용하여 아래 QR 코드를 스캔하십시오. 사용자의 기기가 적합하고 전자적인 사용 설명서를 표시할 수 있는 적절한 소프트웨어가 있는지 확인하시기 바랍니다.</p>
lt	<p>Išsamaus naudotojo vadovo PDF formatu ieškokite interneto svetainėje. Kad jį atvertumėte, specialiu įrankiu arba programėle nuskaitykite toliau pateiktą QR kodą. Įsitinkite, kad jūsų įrenginys yra tinkamas ir turi tinkamą programinę įrangą elektroninems naudojimo instrukcijoms rodyti.</p>
lv	<p>Pilnā lietotāja instrukcija ir pieejama tīmeklī PDF formātā. Lai tai piekļūtu, lūdzu, noskenējiet tālāk redzamo kvadrāt kodu, izmantojot tam paredzētu rīku vai lietojumprogrammu. Lūdzu, pārlicinieties, vai jūsu ierīce ir piemērota un vai tai ir atbilstoša programmatūra elektroniskās lietotāja instrukcijas attēlošanai.</p>
ms	<p>Manual pengguna yang lengkap boleh didapati di ruang laman dalam format PDF. Untuk mengaksesnya, sila imbas kod QR di bawah menggunakan alat atau aplikasi khusus. Sila pastikan yang peranti anda adalah serasi dan mempunyai perisian yang sesuai untuk memaparkan Arahan elektronik untuk tujuan penggunaan.</p>
nl	<p>De volledige gebruikershandleiding is in PDF-formaat beschikbaar op een website. U kunt de handleiding bereiken door de QR-code hiernaast te scannen met een geschikte applicatie. Uw apparaat moet geschikt zijn en over de juiste software beschikken om de elektronische gebruiksaanwijzing weer te geven.</p>
no	<p>Den komplette brukerhåndboken er tilgjengelig på et webhotell i PDF-format. For å få tilgang til den, skann QR-koden nedenfor ved hjelp av et dedikert verktøy eller applikasjon. Sørg for at enheten din er egnet og har en passende programvare for å vise den elektroniske bruksanvisningen.</p>
pl	<p>Kompletna instrukcja użytkownika jest dostępna na stronie internetowej w formacie PDF. Aby uzyskać dostęp, zeskanuj poniższy kod QR przy użyciu dedykowanego narzędzia lub aplikacji. Upewnij się, że urządzenie jest zgodne i wyposażone w odpowiednie oprogramowanie pozwalające wyświetlać elektroniczną Instrukcję obsługi.</p>
pt	<p>O manual do utilizador completo está disponível num espaço online no formato PDF. Para aceder a este, queira digitalizar o QR Code abaixo usando uma ferramenta ou uma aplicação dedicada. Certifique-se de que o seu dispositivo é compatível e possui um software apropriado para exibir as instruções eletrónicas de utilização.</p>
pt (brazil)	<p>O manual do usuário completo está disponível em um espaço online no formato PDF. Para acessar a este, por favor, digitalizar o QR Code abaixo usando uma ferramenta ou um aplicativo dedicado. Seu dispositivo deve ser compatível e possuir um software apropriado para exibir as instruções eletrônicas de utilização.</p>
ro	<p>Manualul de utilizare complet este disponibil online în format PDF. Pentru a-l accesa, scanați codul QR de mai jos folosind un instrument sau o aplicație dedicată. Asigurați-vă că dispozitivul dumneavoastră este potrivit și are un software adecvat pentru afișarea Instrucțiunilor de utilizare în format electronic.</p>
ru	<p>Полное руководство пользователя доступно в интернет-пространстве в формате PDF. Чтобы получить к нему доступ, отсканируйте QR-код ниже с помощью специального инструмента или приложения. Убедитесь, что ваше устройство подходит и имеет соответствующее программное обеспечение для отображения электронных инструкций по эксплуатации.</p>
sk	<p>Celý používateľský manuál je dostupný vo webovom priestore vo formáte PDF. Ak chcete získať prístup, naskenujte nižšie uvedený QR kód pomocou špeciálneho nástroja alebo aplikácie. Uistite sa, že máte vhodné zariadenie s vhodným softvérom na zobrazenie elektronickeho návodu na použitie.</p>

- sl Celoten uporabniški priročnik je na voljo kot dokument PDF na spletnem mestu. Za dostop optično preberite spodnjo kodo QR z namenskim orodjem ali aplikacijo. Prepričajte se, da je vaša naprava primerna in ima ustrezno programsko opremo za prikaz elektronskih navodil za uporabo.
- sr Kompletno uputstvo za korisnike je dostupno na veb prostoru u PDF formatu. Da biste mu pristupili, skenirajte QR kôd u nastavku pomoću namenske alatke ili aplikacije. Proverite da je vaš uređaj odgovarajući i da li ima potreban softver za prikaz elektronskog Uputstva za upotrebu.
- sv Den fullständiga bruksanvisningen finns tillgänglig på ett webbutrymme i PDF-format. För att komma åt den, vänligen skanna QR-koden nedan med ett dedikerat verktyg eller program. Se till att din enhet är lämplig och har en passande programvara för att visa de elektroniska användningsinstruktionerna.
- th สามารถรับคู่มือผู้ใช้ฉบับสมบูรณ์ในรูปแบบ PDF ได้จากบนเว็บไซต์ โดยในการเข้าถึง โปรดสแกนคิวอาร์โค้ดด้านล่างด้วยเครื่องมือหรือแอปพลิเคชันเฉพาะ โปรดตรวจสอบให้แน่ใจว่าอุปกรณ์ของคุณนั้นเหมาะสม และมีซอฟต์แวร์ที่สามารถใช้ในการแสดงคำแนะนำการใช้งานอิเล็กทรอนิกส์ได้อย่างถูกต้อง
- tr Kullanım kılavuzunun tamamı web alanında, PDF formatında mevcuttur. Buna erişmek için lütfen uygun bir araç veya uygulama kullanarak aşağıdaki QR kodunu okutun. Lütfen cihazınızın uyumlu ve elektronik kullanım talimatlarını görüntülemek için uygun bir yazılıma sahip olduğundan emin olun.
- uk Повна версія посібника користувача доступна в інтернеті в форматі PDF. Щоб отримати до нього доступ, скануйте QR-код нижче за допомогою спеціального додатку. Для перегляду електронного посібника користувача на вашому пристрої він повинен мати відповідні характеристики та програмне забезпечення.
- vi Hướng dẫn sử dụng đầy đủ có sẵn trên không gian web ở định dạng PDF. Để truy cập, vui lòng quét mã QR bên dưới bằng công cụ chuyên dụng hoặc bằng ứng dụng. Vui lòng đảm bảo rằng thiết bị của bạn phù hợp và có phần mềm phù hợp để hiển thị Hướng dẫn sử dụng điện tử
- zh 完整的操作手册以 PDF 格式在网络上提供。如需获取，请使用专门的工具或应用程序扫描下方二维码。请确保您的设备适用并安装有相应的软件，能够显示电子版使用说明。





Essilor International  
147, rue de Paris – 94220 Charenton-le-Pont France  
[www.essilor.com](http://www.essilor.com)

