

VISION-R 700



USER MANUAL

CONTENTS

I. INTRODUCTION	6
II. SUPPLY PACKAGE	8
1. Unpacking and storage	9
2. List of accessories	9
a. Standard accessories	9
b. Optional accessories	9
c. Detachable parts	9
III. GENERAL DESCRIPTION	10
1. Intended use	11
a. Intended purpose	11
b. Indications for use	11
c. Expected clinical benefit	11
d. Intended population	11
e. Intended users	11
2. Device description	11
a. Refraction head - (Ref. V01112)	12
b. Console - (Ref. V01KB1)	13
c. Power supply box - (Ref. V01PS1)	14
d. Test presentation screen	15
IV. INSTALLATION / CONNECTION	16
1. Installation of the device	17
2. Turning ON/OFF	17
a. Turn on the instrument	17
b. Turn off the instrument	18
3. Connection to other instruments	18
V. USE OF THE DEVICE	19
1. Configure the instrument	20
a. Set the instrument data to zero	20
b. Pass from the manual mode to the automatic mode	20
c. Import and export data	21
2. Setting up the patient	22
a. Adjusting the horizontality of the refraction head	22
b. Adjusting the inter-pupillary distances	23
c. Adjusting the forehead rest	25
d. Going from far-vision mode to near-vision mode	25
VI. BASIC FUNCTIONS FOR PERFORMING A REFRACTION EXAMINATION	27
1. Choose a test	28
a. Select a test	28
b. Start an existing test program	29
2. Checking the optical module	31
a. Changing the checked eye	31
b. Change the controlled settings	31
c. Modify the power and the incrementation steps	32
d. Modify the incrementation steps	33
e. Value locking function	34
3. Mask an eye and check the filters	35
a. Check the masks	35

b. Check and modify the filters	35
c. Modify the type of occlusion	36
4. Manage the patient data	37
a. Add a patient folder	37
5. Access with contextual assistance	38
VII. PERFORMANCE OF TESTS DURING A REFRACTION EXAMINATION	40
1. Patient refraction data input	41
a. Objective	41
b. Data importing from Essibox.com	41
c. Manual entry	42
2. Standard tests	45
a. Refraction tests	45
b. Near vision tests	68
3. Smart tests	69
a. Refraction tests	69
4. Refraction comparison (Bluetouch)	74
a. Alert function in the comparison screen	76
VIII. MEASUREMENT	78
1. Vertex distance measurement	79
IX. REFRACTION PROGRAMS	82
1. Standard programs	83
2. Customized programs	83
a. Editing and customizing programs and tests	83
b. Favorite tests selection	91
X. INSTRUMENT SETTINGS	95
1. General information	96
2. Measurement data	100
3. Import/Export data	102
4. Communication settings	105
5. Local settings	107
6. Backups restore	108
XI. ERROR DISPLAY	111
XII. SAFETY CONSIDERATION	113
1. Symbols (document, device & packaging)	114
a. On the document	114
b. On the device and packaging	114
2. Precautions for use	115
3. Contraindication	116
4. Side effects	116
5. Exclusion of liability clause	116
6. Power source	116
7. Precautions regarding IT Network	117
8. Electromagnetic compatibility	118
a. Length of cables, cords, etc.	118
b. Recommended separation distance	118
c. Electromagnetic emissions	118
d. Magnetic and electromagnetic immunity	119
e. Electromagnetic immunity, radio frequencies	119

XIII. TROUBLESHOOTING	121
XIV. MAINTENANCE	123
1. Storage and handling condition	124
2. Cleaning	124
a. Cleaning and disinfection the head	124
b. Cleaning the console	125
3. Periodical inspection and maintenance	125
4. Disassembly of the product and transport	125
5. Disposal	126
XV. SPECIFICATIONS	127
1. Technical data	128
a. Centering	128
b. Measurement range	128
c. Auxiliary lenses	128
d. Dimensions and weight	128
e. LEDs	129
f. Input/Output	129
2. Connectivity to other devices	129
3. It requirements	129
XVI. QR CODE	130

I. INTRODUCTION





The latest version of this user manual is available on a web space.
To access other available languages, please scan the QR code available at the end of this user manual > QR Code Chapter (p. 130).

For a safer, more effective use, follow the instructions outlined in this manual.

Copyright © 2023 Essilor - Original manual - All rights reserved.

All reproduction of the content of this document, whether in part or as a whole, for the purpose of its publication or dissemination by any means and in any format whatsoever, even free of charge, is strictly prohibited without Essilor's prior written consent.

II. SUPPLY PACKAGE



1. Unpacking and storage

This section is not applicable.

2. List of accessories

While unpacking, check that the following standard accessories are included.

a. Standard accessories

- Communication cables:
 - 1 electric cable running from the refraction head (2 m) with a 1 extension (2 m)
 - 1 electric cable running from the console (7 m)
 - 2 network cables running to the local network
- Face shield, ref V01S47 (x2)*
- Forehead rest (x1)
- Forehead rest cover, ref V0122G (x2)*
- Near vision test chart with near vision test bar (70 cm) and near vision test chart, ref V01S50
- Screw attachment of the head M6 (x1), mounted on the arm
- Screw of safety M5 (x1)
- M4 (x1) and M5 (x1) Allen key
- 16 Gb USB key, ref CE7781
- Protective cover:
 - Refraction head, ref V01A01 (x1)
 - Console, ref V01A02 (x1)
- Quickstart Guide (x1)
- Screw M5 (x4) for fixing the power supply box if needed
- Plastic bag with a cable support and 1 screw, to fix on the power supply box
- Cleaning swab (x20)
- Disinfectant wipes (x100)

* Applied parts



The forehead rest cover is applied to improve patient comfort.

b. Optional accessories

- Printer
- Printer paper (x5)

c. Detachable parts

- Power cable 2 m (x1), Europe type
- Power cable 2 m (x1), US type



Vision-R™ 700 is entirely compatible with chart systems approved and connected by Essilor Instruments.

III. GENERAL DESCRIPTION



Vision-R™700 (V01) is an automated phoropter that enables you to perform a refraction test. Its function is to determine optical correction (or compensation), thereby providing examinees with optimal vision. This device performs a subjective refraction.

This part of the eye examination is commonly referred to as subjective refraction, because it refers to the patient's responses. In the majority of cases it is performed using preliminary data which may come from:

- The old correction performed using the lensmeter,
- From a measurement of the objective refraction using an auto-refractometer, an aberrometer or a skiascope/retinoscope,
- The old correction archived in a patient file.



Since this is a so-called “automatic” head, its integration into the examination environment also includes the control of the test projection systems from the same control panel.

The patient's subjective refraction is made possible by inserting an optical correction or a diopter compensation and/or filters in front of the patient's eyes.

The measurements can be taken under monocular or binocular vision conditions and subsequently allow for a binocular vision examination to be performed.

The instrument allows the user to carry out continuous variations of optical characteristics (sphere, cylinder, axis and prism).



The intended part of the body applied to the device are: cheeks and front skin are in contact with the device. Skin in contact with the device must be in healthy condition without wounds, irritation or inflammation.



Operating principle

The phoropter is used to determine subjectively the optical correction required for a patient. To explore his visual functions, different lenses (inside the pre-refraction head) are placed between the patient's eye and an optotype or a chartscreen. The practitioner asks the patient some questions and the patient responds according to what he perceives through the lenses. The patient's answers are used to establish the diagnosis.

1. Intended use

a. Intended purpose

Vision-R™700 is intended to perform a subjective assessment of ametropia or visual function capability.

b. Indications for use

Assessment of Ametropia or/and Binocular vision disorder or exploration of visual function abilities.

c. Expected clinical benefit

Accurate determination of the refractive error and visual acuity.

d. Intended population

Any adult or child with pupillary distance from 49mm to 80mm.

e. Intended users

This device is intended for eye care professionals use only.

2. Device description

The main components that make up the Vision-R™ 700 unit are:

- A refraction head
- A console
- A power supply box

a. Refraction head - (Ref. V01112)

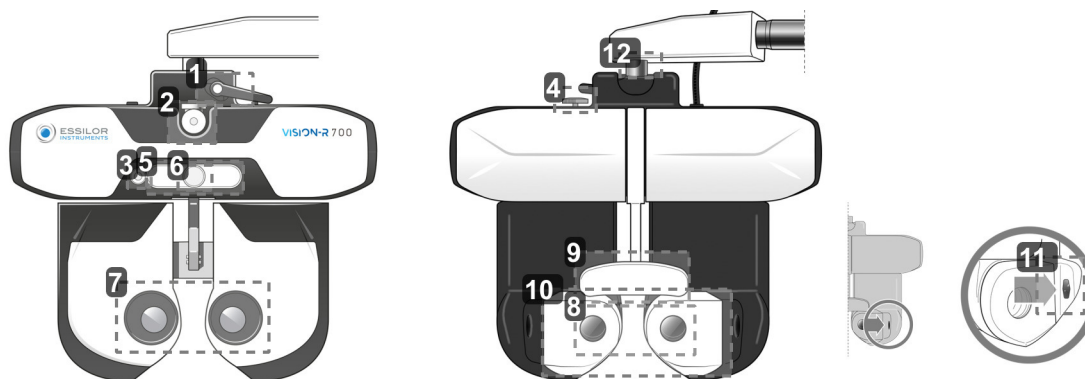

1. Tilt blocking lever

Used to adjust the tilt angle (near vision position) and block it.

2. Near vision test support rod hook

Used to position the near vision test chart support rod.

3. Near vision camera

4. Horizontal adjustment knob

Used to adjust the horizontality of the refraction head.

5. LED panel

Used for:

- Adjust the horizontality of the head and to illuminate the near-vision card.
- Call up the tests display on the screen.

6. Forehead rest adjustment knob

Used to adjust the Vertex distance by advancing or moving back the forehead rest.

7. User-side observation windows

Patient eyes observation side.

8. Patient side observation windows (SCV module)

Patient side: front area where the patient is positioned and through which he or she looks during the eye test.

9. Forehead rest cover* and forehead rest

Area on which the patient's forehead must rest during the test.

*Applied part.

10. Movable face shield

Area which may be in contact with the patient's cheeks.

Applied part.

11. Measurement cameras for Vertex distance

Used to measure the Vertex distance of the patient and to light up their eyes if necessary during the pupillary distance adjustment.

12. Rotation axis

360° rotation movement, during the handling of the instrument.

b. Console - (Ref. V01KB1)



1. Touch screen

2. Touch [Clear]



Used for:

- Resetting the current session (quick press).
- Turning the instrument on or off (long press).

3. Keys [Import/export]

Used for importing  and exporting  the patient's refraction data.

4. Touch [Far vision/Near vision]

Used for changing to far-vision mode  or near-vision mode .

5. Touch [Bluetouch]

Used for comparing different refraction measurements and rendering the data.

6. Buttons [R/BINO/L]

Used for selecting the vision condition:

- Monocular right eye (R) by de-selecting and blocking out the left eye.
- Monocular left eye (L) by de-selecting and blocking out the right eye.
- Binocular (Bino)

7. Keys [+/-]

Used for increasing or decreasing the power values.

- Key "+": allows you to increment the positive power values.
- Key "-": allows you to increment the negative power values.

8. Keys [Position 1/Position 2]

Used for:

- Navigating through the list of variation steps of the selected optical setting
- Introducing one of the two positions of the cross cylinder while performing the cross-cylinder test

9. Central button

Used for:

- Modifying (+), the power values via rotation of the central button
- Navigating through the controlled settings (e.g. S, C, A) by pressing the central button

10. Acuity navigation buttons

Used for:

- Navigating through the acuity charts (changing the size of the letters, charts, lines or columns) and saving the answers.
- Navigating through the answers of the dissociated tests
- Confirming the answers of the dissociated tests with the middle button



There are two USB ports located on the side of the console.



c. Power supply box - (Ref. V01PS1)

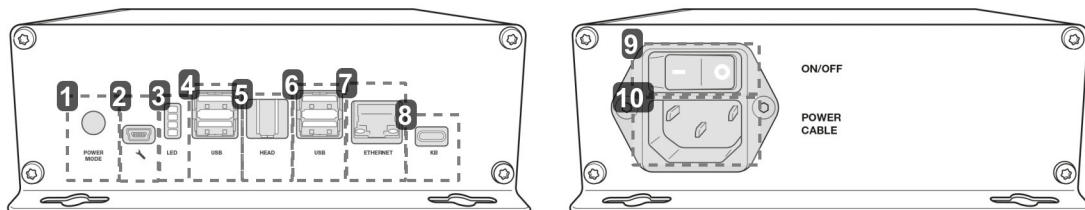

1. Start-up mode

- Position 1: turning on the refraction head by pressing on On/Off with the console.
- Position 2: turning on the phoropter head using the ON/OFF switch on the power supply box.

2. Service technician socket

3. Information indicator lights

4. USB port

5. Refraction head connection port

Used for the connection to the phoropter head.

6. USB port

7. Ethernet port

8. Console connection port

Used for the connection to the console

9. On/off switch

Network isolation switch.

10. Power cable socket

d. Test presentation screen

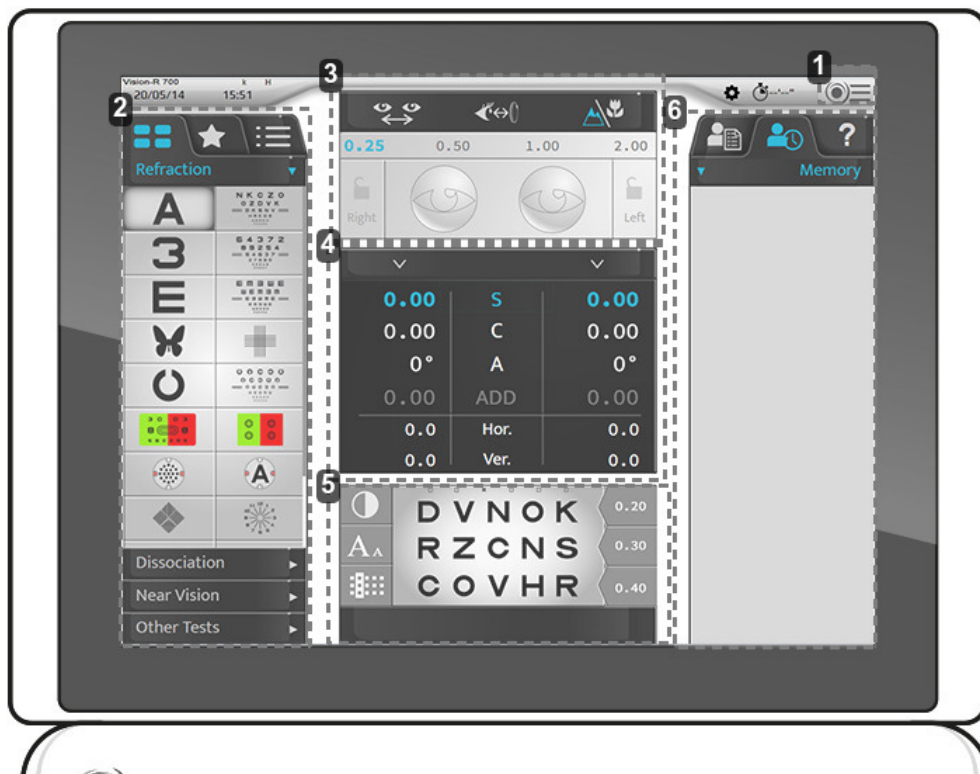

1. Access to the main menu

Permits access to the instrument configuration screens.

2. Optotypes, tests

Used to display the various categories of types and tests (manual or automatic), associated optotypes and programs.

3. Configuration for the setup of the patient

Used to check and manage:

- The inter-pupillary distance.
- The Vertex distance.
- The far vision or near vision mode.
- To apply filters or masks to the eyes of the patient.
- To modify the steps of the current setting.
- To lock an eye.

4. Controlled parameters

Used to select and modify the values of the presented optical settings.

5. Visualization of the current test.

Used to visualize, personalize the test in progress and to include the answers of the patient.

6. Management of the patient data and user help display

Allows you to:

- Manage the patient data.
- Display and call up memorized data.
- Display the contextual assistance.

IV. INSTALLATION / CONNECTION

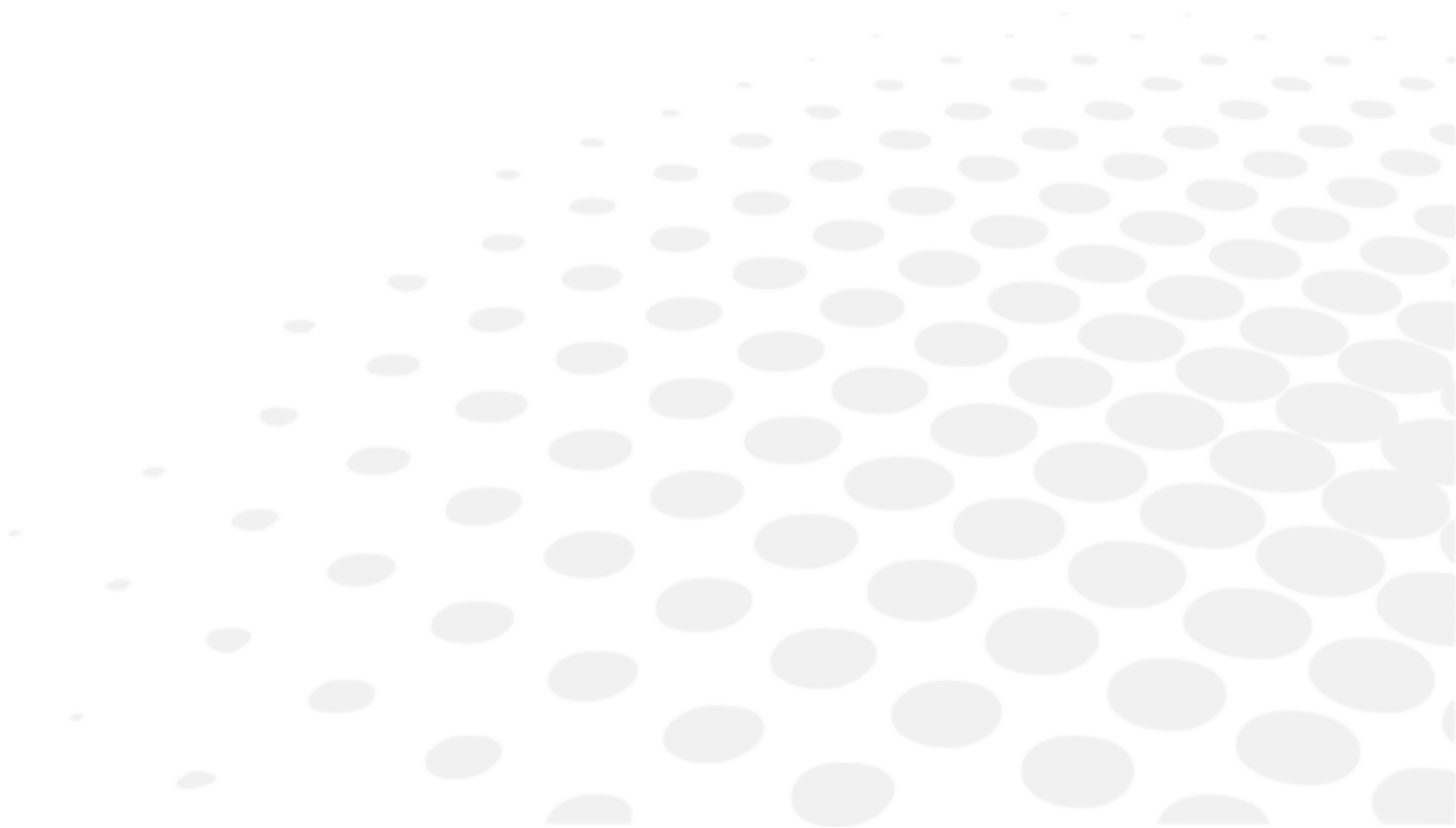



This instrument must be installed by a specialized technician. To install the instrument or to change its connection, please contact your Essilor dealer.

Respect the precautions below:

- Do not install the instrument in a location:
 - where dust or dirt accumulates,
 - directly exposed to the light rays,
 - oxygen rich,
 - displaying extreme temperatures and humidity levels,
 - likely to undergo strong oscillations or sudden shocks.
- Do not use the instrument with flammable anaesthetics or in conjunction with flammable agents.
- The instrument should not fall; that would likely cause malfunctions. If it does fall, the instrument could also crush your body or feet.
- Do not place your hand between the mounting arm and the instrument. You could get your hand wedged.
- To avoid any risk of injury, be careful when installing or using the near-vision support bracket.

1. Installation of the device



Position the mounting arm to the phoropter head and attach it using the fixing screw (6-sided key).

> To prevent the phoropter head from falling, fasten it with the screw located below the arm of the head.

> Despite the holes, the power supply box does not need to be fixed.

> But, if you want to fix the power supply horizontally you need to use 4 M5 screws.

2. Turning ON/OFF

a. Turn on the instrument

- 1 During the first powering up of the instrument, press the ON/OFF switch on the power supply unit.



For future instrument use, the power unit can stay turned on.

In this case, go directly to step 2.

- 2 Press on the ON/OFF switch [Clear] on the console.



> The system is initialized (refraction head and console).

- 3 Then, press the ON/OFF switch on the chart screen.

> The instrument is ready to be used.

b. Turn off the instrument

- 1 Press and hold the ON/OFF switch [Clear] on the console.
 - > The message [Clear all dated] is displayed.
- 2 Hold the switch down until the console turns off.
 - > The console turns off.

3. Connection to other instruments



With:

- █ Cable connection
- █ Infrared connection
- * Wall plug RJ-45

V. USE OF THE DEVICE

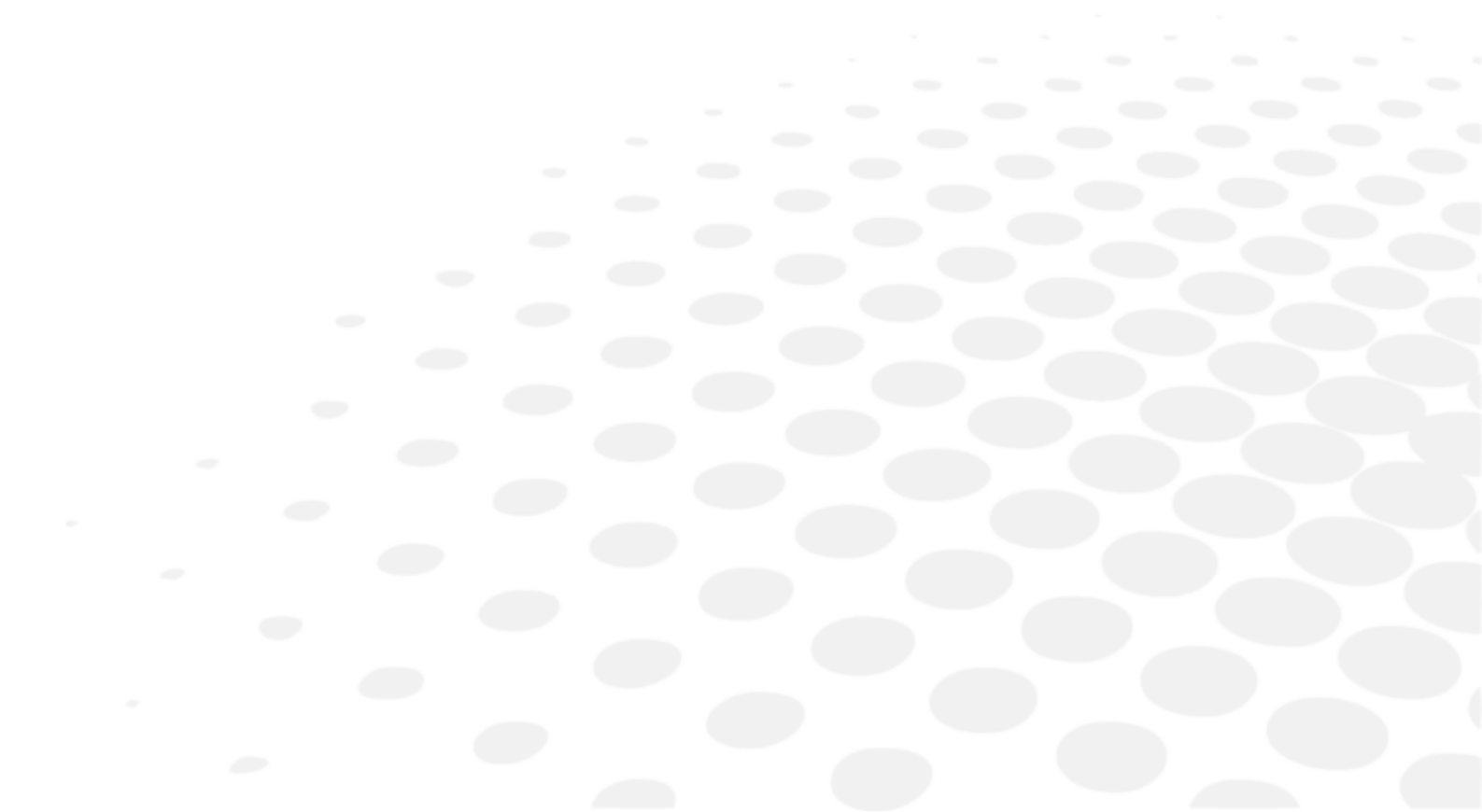

1. Configure the instrument



a. Set the instrument data to zero

At the end of each examination, it is possible to set the instrument data to zero. The expert can then start a new session with a new patient.

Restoring the instrument data can be carried out:

- On the console keyboard, by quickly pressing on the key [Clear].



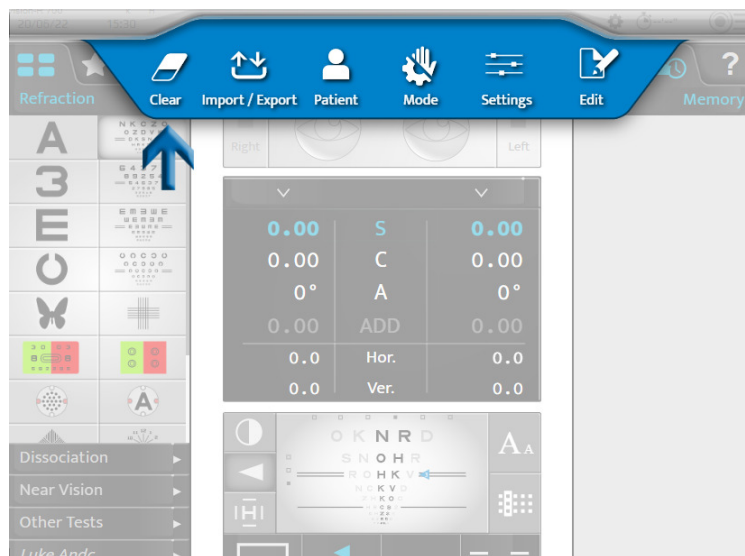

- On the touch screen, by pressing on  > .





 The restoring of the patient data does not cause the instrument to turn off.

b. Pass from the manual mode to the automatic mode

Changing from manual mode to automatic mode can be carried out on the touch screen by pressing on:



-  >  or,
-  (displayed by default).

 Once the mode is chosen, the display of the upper strip changes:



-  for manual mode.
-  for automatic mode.

c. Import and export data

The importing and exporting of the instrument data can be carried out:

- On the console keyboard, by pressing on the [Import]  or [Export]  keys.



- On the touch screen, by pressing on  > .



Once import or export has been selected, the corresponding windows open:

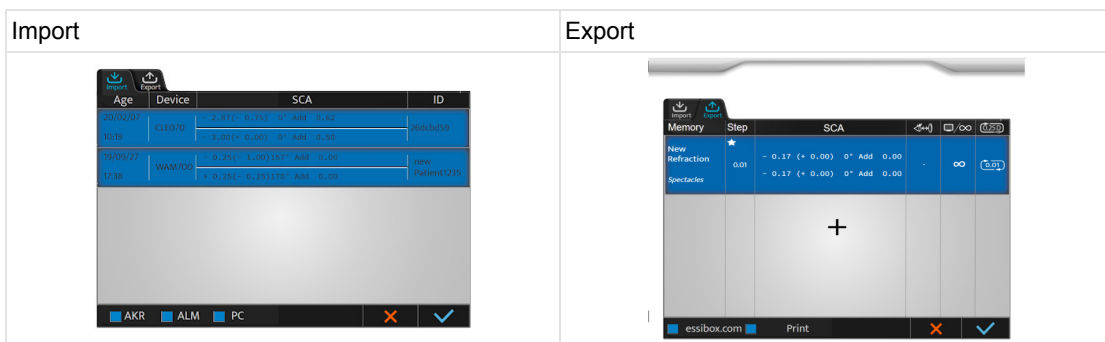

It is possible to choose which data should be imported:

- AKR (Auto-kerato-refractometer)
- ALM (Lensmeter)
- PC (Computer)

The data is saved automatically in the corresponding memory.

Press:

- ✓ to confirm the importing or the export of the data.
- ✗ to cancel the importing or the export of the data.



You can select several types of products.

2. Setting up the patient

Before each refraction examination, perform various adjustments.



The adjustment below can be carried out via the touch screen or the keyboard on the console.

It is advisable to adjust:

- The horizontality of the refraction head with the knob located on the top of the refraction head,
- Monocular or Binocular pupillary distances ,
- The forehead position with the knob located on the front of the refraction head.

It is also advisable to check the Vertex distance .





Correct installation must:

- Allow the patient to have a comfortable posture which guarantees his or her stability throughout the examination.
- Prevent the patient from being in contact with the optics (eyelash rubbing for example).

a. Adjusting the horizontality of the refraction head

Horizontality adjustments are performed manually by using the knob located on the top of the refraction head.

In pupillary distance mode , the LEDs placed on the front of the head provide an indication of its horizontality. If:

<ul style="list-style-type: none"> • when both LEDs are lit up, the adjustment is correct. 	
<ul style="list-style-type: none"> • when only one of the LEDs flickers or if a LED is not lit up, it is necessary to adjust the horizontality by using the adjustment knob. 	

b. Adjusting the inter-pupillary distances

Before adjusting the distances, position the refraction head in front of the patient's eyes and ensure that the patient is comfortably seated. The chart screen must be in the middle of the patient's field of vision.

The adjustment of the inter-pupillary distances is carried out via the console touch screen by pressing on .

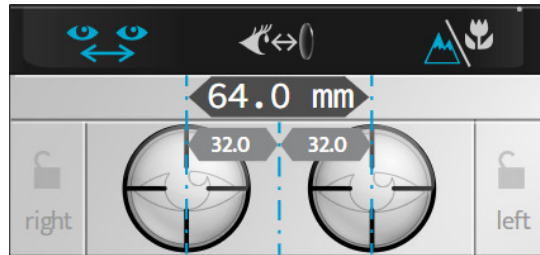

> The reticles are placed in front of the patient's eyes and the right and left distance values are displayed.



It is possible to regulate the pupillary distances in far vision and near vision.

The value:

- Of an eye corresponds to monocular half PD,
- Of the two eyes corresponds to the total binocular distance.



By default, the step is 1 mm for the total distance.

The adjustment of the inter-pupillary distances can be carried out on the console:

- By turning the central button clockwise or counterclockwise.

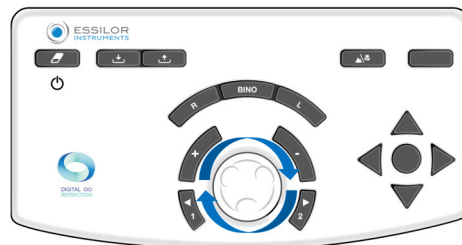

- By pressing on the keys [+/-].

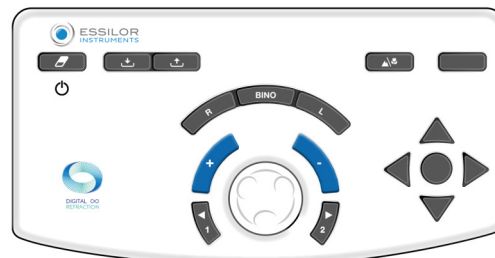

- Or,

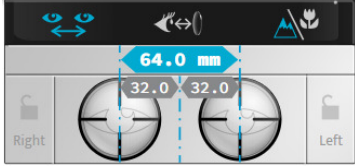
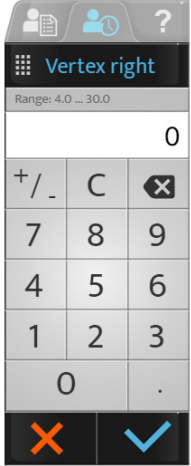
By pressing the PD portion	And entering the values on the keyboard.
	

c. Adjusting the forehead rest

The forehead rest adjustment is performed manually thanks to the knob located on the front of the head of refraction.



Adjustment of the forehead rest affects the Vertex distance. So, it is better to place the refraction head as close as possible to the patient's eyes.

Check the Vertex distance

The inspection of the Vertex distance is performed on the touch screen by pressing on .

> Images of the patient's right eye and the left eye appear at the top of the console screen.

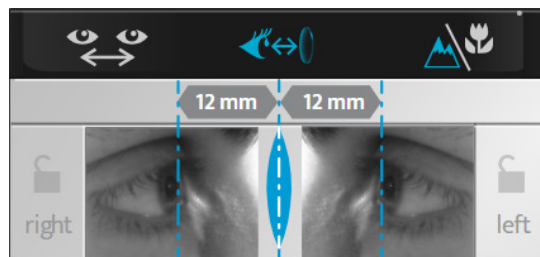

> Adjust the position of the vertical lines to match the corneal apex of each eye using the central button or the incrementation keys (+/-) on the console keyboard.



The Vertex distance can be modified by adjusting the forehead rest using the knob located on the front of the refraction head.





To refresh the image, press the touchscreen on the eye and a new picture will be taken.

d. Going from far-vision mode to near-vision mode

Going from far-vision mode to near-vision mode can be performed:

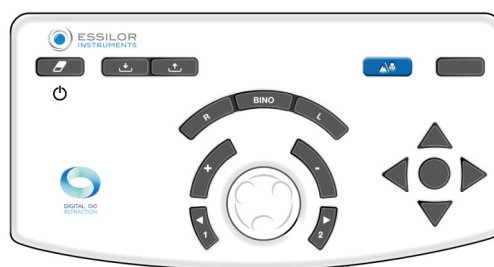

- On the console keyboard, by pressing on the key [NV/FV].



- On the touch screen, by pressing on .



The icon corresponding to the selected mode is displayed in blue on the interface:

-  for far-vision mode.
-  for near-vision mode.



Switching to near vision mode modifies, the inter-pupillary distances, the convergence of the refraction head and the lighting up of the LEDs.

VI. BASIC FUNCTIONS FOR PERFORMING A REFRACTION EXAMINATION



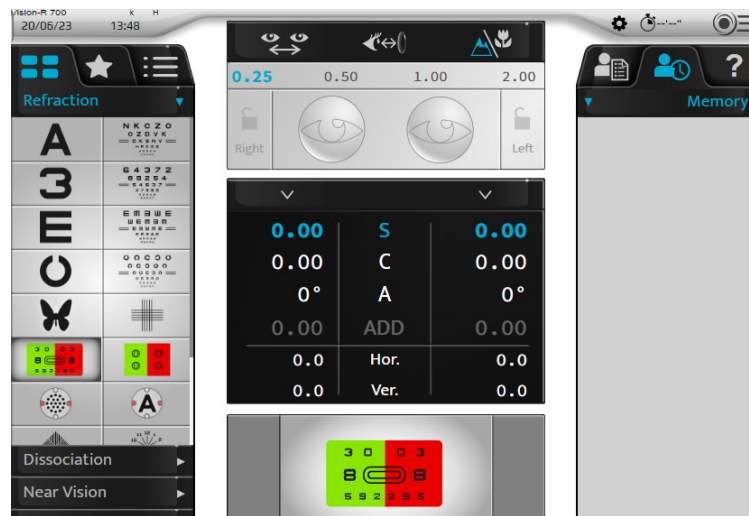

1. Choose a test

The choice of the "manual" tests is done on the left part of the main screen.



Several test formats are available. Press:

-  to access the list of tests available,
-  to access the pre-selected favorite tests,
-  to access the standard or personalized test programs.



a. Select a test

Press on the icon of the test that you want to start. A visualization of the test is displayed at the bottom of the main screen.



When you select a test, the controlled settings as well as the applied filters are automatically modified.

If you wish to deactivate this function, go into manual mode on the touch screen by pressing on:

-  or,
-  (displayed by default).

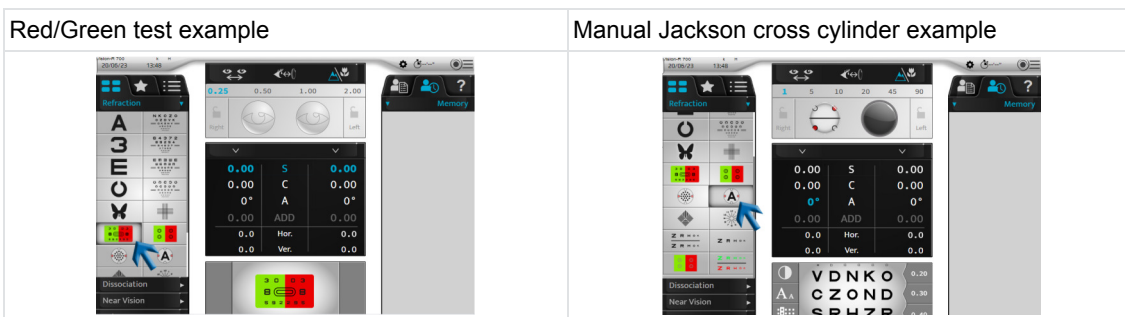

b. Start an existing test program

- 1 Press on the icon of the test program .

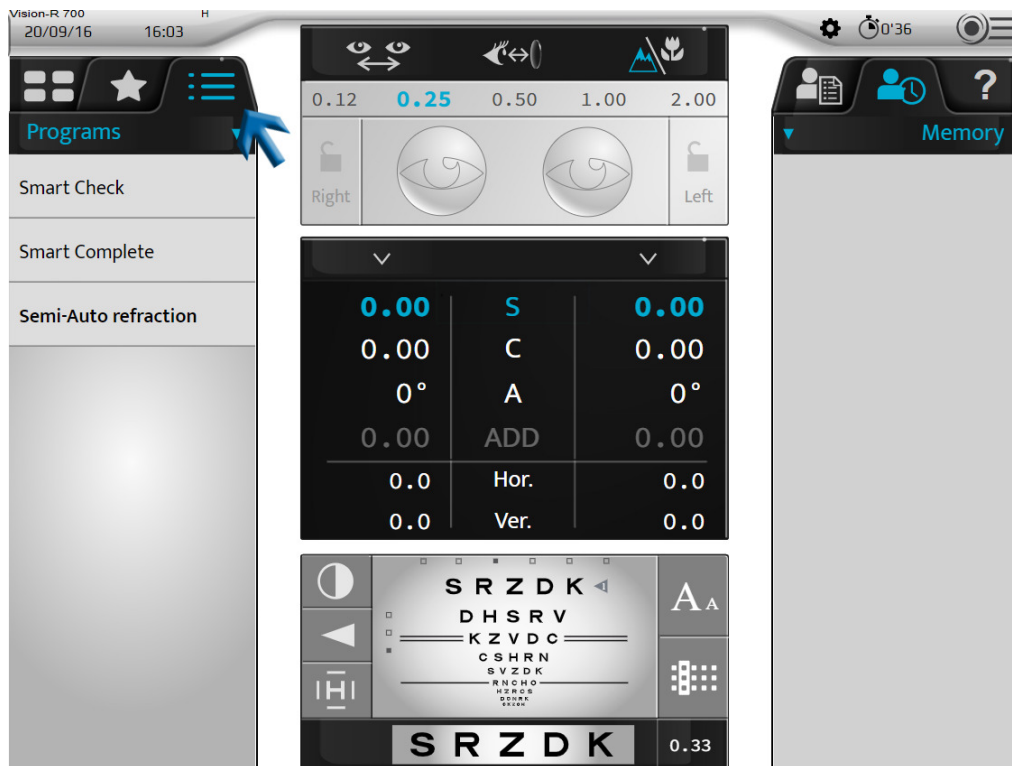

- > The list of available test programs are displayed depending of the lensmeter, autorefractometer memories and/or age of the patient, one program is suggest.

This one appears in bold.



The Vision-R™700 has the ability to recommend the best program to perform on the patient. This recommendation is calculated by the information imported into the phoropter.

For the most completed recommendation the ECP will need to enter objective measurement, lensmeter and age of the patient. Then, the recommended program will appear in bold.

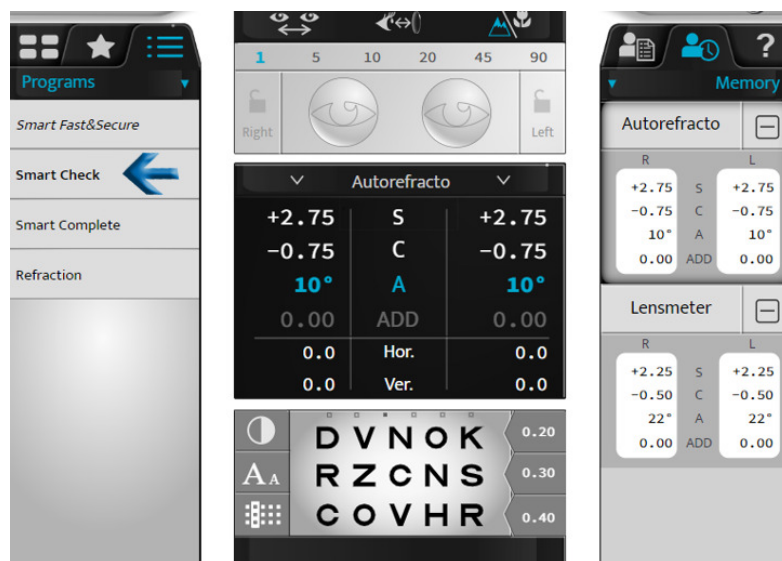

2 Select the program that you wish to use.

> The test program is displayed and the first test is set up automatically.

You can:

- Follow the program's progression on the progression bar.
- Leave the program at any time by clicking on [STOP].
- Go to the following test by pressing on:
 - the associated icon,
 - [NEXT] in the case of smart tests.

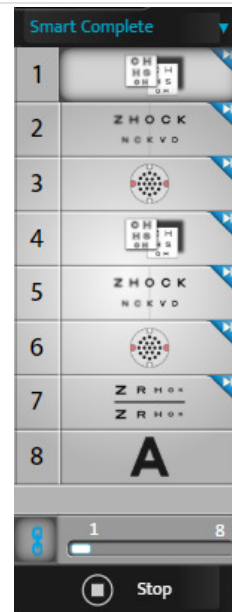



Click on the link if "auto next" needs to be de-activated.



"Auto next" is a feature to help speed up the process and help the ECP to perform less actions. When this feature is activate, the Smart Program will automatically move to the next test and start it immediately. If this feature is deactivated, the program will ask you to initiate the next test once the end point has been calculated in the current test.



If you wish to select a test outside the program in progress, press on the test list  or favorite tests  icons.

It is possible to return to the running program by pressing on the corresponding icon.

2. Checking the optical module

a. Changing the checked eye

Selecting the examined eye can be done:

- On the touch screen by selecting:
 - the power of the right eye or the left eye, for the separate inspection of each eye or,
 - on the settings (S, C, A, ADD, Hor., Ver.) for the simultaneous inspection of both eyes.

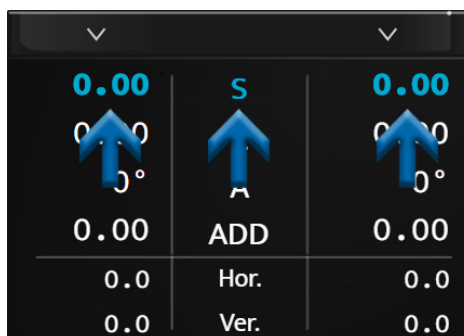

- On the console keyboard, by pressing on the keys [R, BINO, L].

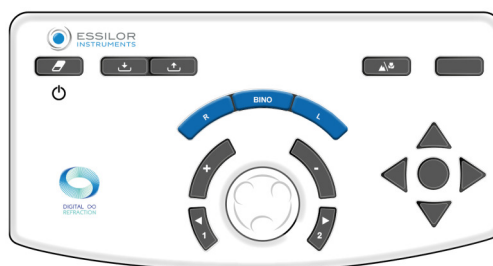

b. Change the controlled settings

Moving from one controlled setting (S, C, A, ADD, Hor., Ver.) to another can be carried out:

- On the touch screen, by pressing on the setting that you wish to check (on the value of the right eye or the left eye or on the setting).

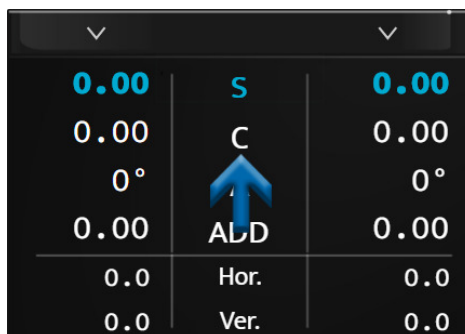

- On the console keyboard, by pressing on the central button.

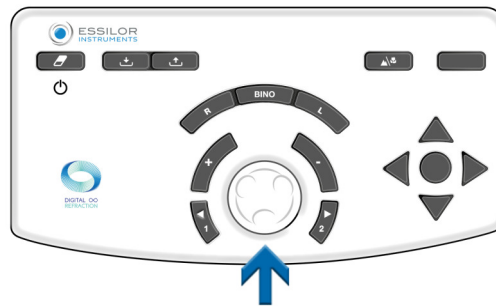

Depending on the instrument's status, the operation can be carried out in various ways:

Far vision	Near vision	Prism																																																						
<table border="1"> <tr><td>0.00</td><td>S</td><td>0.00</td></tr> <tr><td>0.00</td><td>C</td><td>0.00</td></tr> <tr><td>0°</td><td>A</td><td>0°</td></tr> <tr><td>0.00</td><td>ADD</td><td>0.00</td></tr> <tr><td>0.0</td><td>Hor.</td><td>0.0</td></tr> <tr><td>0.0</td><td>Ver.</td><td>0.0</td></tr> </table>	0.00	S	0.00	0.00	C	0.00	0°	A	0°	0.00	ADD	0.00	0.0	Hor.	0.0	0.0	Ver.	0.0	<table border="1"> <tr><td>0.00</td><td>S</td><td>0.00</td></tr> <tr><td>0.00</td><td>C</td><td>0.00</td></tr> <tr><td>0°</td><td>A</td><td>0°</td></tr> <tr><td>0.00</td><td>ADD</td><td>0.00</td></tr> <tr><td>0.0</td><td>Hor.</td><td>0.0</td></tr> <tr><td>0.0</td><td>Ver.</td><td>0.0</td></tr> </table>	0.00	S	0.00	0.00	C	0.00	0°	A	0°	0.00	ADD	0.00	0.0	Hor.	0.0	0.0	Ver.	0.0	<table border="1"> <tr><td>0.00</td><td>S</td><td>0.00</td></tr> <tr><td>0.00</td><td>C</td><td>0.00</td></tr> <tr><td>0°</td><td>A</td><td>0°</td></tr> <tr><td>0.00</td><td>ADD</td><td>0.00</td></tr> <tr><td>0.0</td><td>Hor.</td><td>0.0</td></tr> <tr><td>0.0</td><td>Ver.</td><td>0.0</td></tr> </table>	0.00	S	0.00	0.00	C	0.00	0°	A	0°	0.00	ADD	0.00	0.0	Hor.	0.0	0.0	Ver.	0.0
0.00	S	0.00																																																						
0.00	C	0.00																																																						
0°	A	0°																																																						
0.00	ADD	0.00																																																						
0.0	Hor.	0.0																																																						
0.0	Ver.	0.0																																																						
0.00	S	0.00																																																						
0.00	C	0.00																																																						
0°	A	0°																																																						
0.00	ADD	0.00																																																						
0.0	Hor.	0.0																																																						
0.0	Ver.	0.0																																																						
0.00	S	0.00																																																						
0.00	C	0.00																																																						
0°	A	0°																																																						
0.00	ADD	0.00																																																						
0.0	Hor.	0.0																																																						
0.0	Ver.	0.0																																																						

c. Modify the power and the incrementation steps

Modify the power

The modification of the power can be carried out:

- On the touch screen, by pressing a second time on the desired controlled setting.



> In this case, a numeric keypad is displayed. Enter the desired value and confirm ✓.

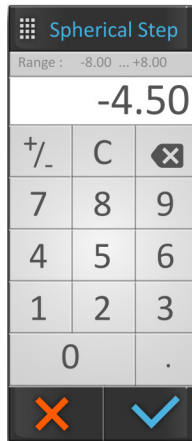

Once input is complete, do not forget to save the initial prescription in the memory of your choice.

- On the console keyboard:
 - by turning the central button clockwise or counterclockwise, or

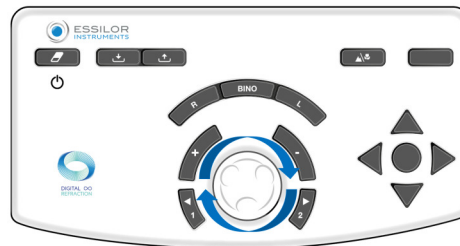

- by pressing on the keys [+/-].

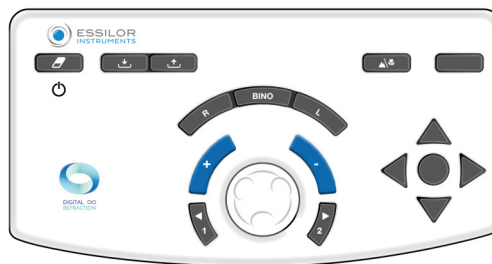

Example:

If you wish to modify the sphere (S), it is possible to modify the values of the right eye or the left eye independently, or both at the same time by selecting "S" directly.

d. Modify the incrementation steps

Three step variation choices are configurable:

1. Sphere and cylinder variation step
2. Axis variation step
3. Prism variation step

The value is displayed in the upper blue strip and depends on the active setting.

The unit and the step value depend on this setting. The modification of the incrementation step can be carried out:

- On the touch screen, by selecting the desired step value.



- On the console keyboard, by pressing on the keys [1 and 2].

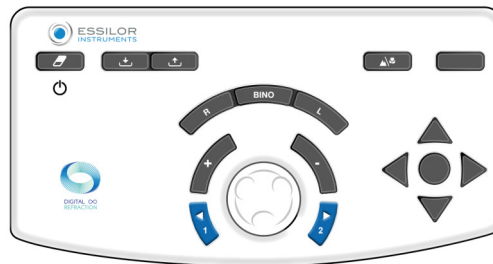

According to the controlled settings, the values are not the same:

- The sphere (S), the cylinder (C) and additions (ADD) are displayed in diopters and are adjustable to 0.25, 0.50, 1.00, 2.00D.
> **By default, the step is 0.25D.**
- The axis (A) are displayed in degrees and are adjustable to 1°, 5°, 10°, 20°, 45° or 90°.
> **By default, the step is 5°.**
- The prisms (Hor. and Vert.) are displayed in prismatic diopters and are adjustable to 0.1, 0.5, 1.0, 2.0, 3.0 or 6.0D.
> **By default, the step is 1D.**

e. Value locking function

The value locking function is useful if you wish to lock in different values. To do this, press on the lock icon.

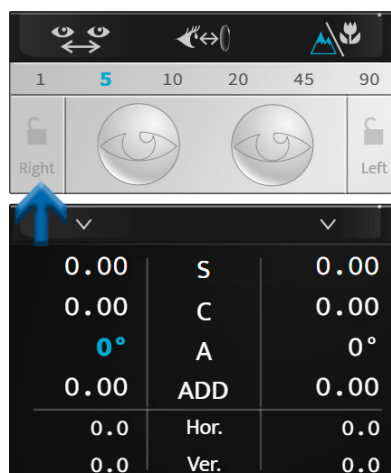



The icon of a closed lock is displayed, the values are grayed and cannot be modified any more.

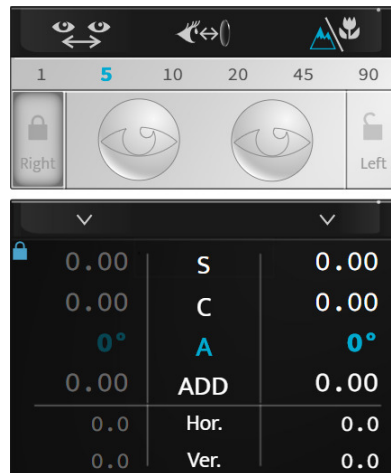

To unlock the values, press on the lock icon again.

3. Mask an eye and check the filters

a. Check the masks

Press on the eye which you wish to mask.

> The mask is applied automatically in front of the eye of the patient.



The mask can be:

- A black mask.
- A spherical power, in this case a lens of this power is applied in front of the eye of the patient.
 - > The value of this is displayed on the selected eye.



The mask set up is automatic during the automated refraction tests, contrary to the dissociated tests.



If you wish to deactivate this function, go into manual mode on the touch screen by pressing on:

- or,
- (displayed by default).

b. Check and modify the filters

To personalize the filters to be applied in front of the eyes of the patient, press and hold on one of the two eyes.

A window opens:



You can select the different filters:



- Monocular, separate right eye and left eye,
- Binocular with filter couples.



The action is manual. If filters are applied for a test, the adjustment is temporary up to the start of a new session.

The selected filters are displayed in the top part of the window.

Once this is done, press on:

-  to confirm the selection.
-  to cancel.

c. Modify the type of occlusion

To personalize the type of occlusion to be applied in front of the unchecked eye, press and hold on one of the two eyes.

A window opens:

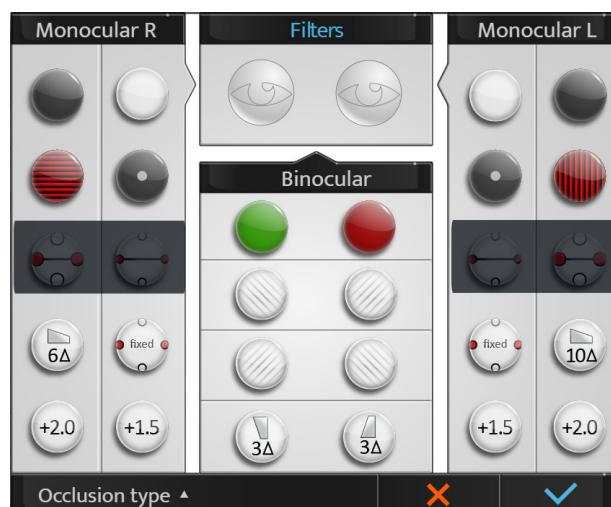



Press on [Occlusion type] and select the desired type of occlusion from the list:



The action is manual. If a type of occlusion is applied, the adjustment is temporary up to the start of a new session.

4. Manage the patient data

a. Add a patient folder

To create a patient folder press on  .

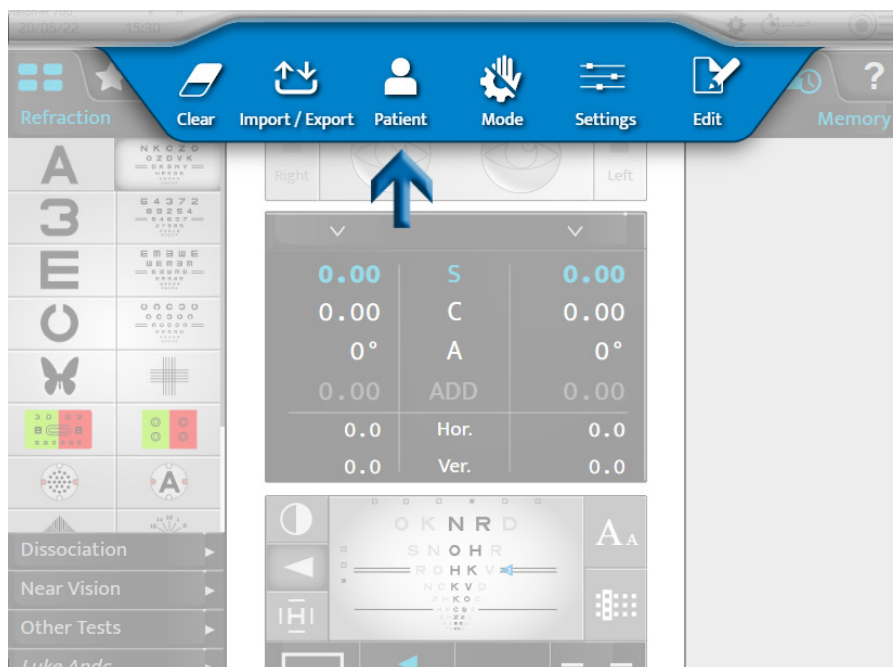

> The patient folder creation page is displayed:

Fill in the required fields:



Reminders

- ♂: male
- ♀: female

Once the folder is filled in, press on:

- ✓ to confirm.
- ✗ to cancel.

5. Access with contextual assistance

To access with contextual assistance, press on **?**.

The phraseology of the tests as well as actions to be performed on the console are displayed on the right part of the screen.



If you wish to display more information on the test, press on [More help] .

An additional help page is displayed:



Press on  to close the page.

VII. PERFORMANCE OF TESTS DURING A REFRACTION EXAMINATION



1. Patient refraction data input

a. Objective



Before performing the refraction tests, it is necessary to first enter the data of patient's initial refraction into the instrument.

These data can come from:

1. The previous measured refraction on the glasses of the patient,
2. The objective refraction:
 - o measured with the auto-refractometer or a skiascope/retinoscope,
 - o determined by an aberrometer.
3. The patient folder.

b. Data importing from Essibox.com

The patient refraction data importing from Essibox.com can be done:

- On the touch screen, by pressing on  > .

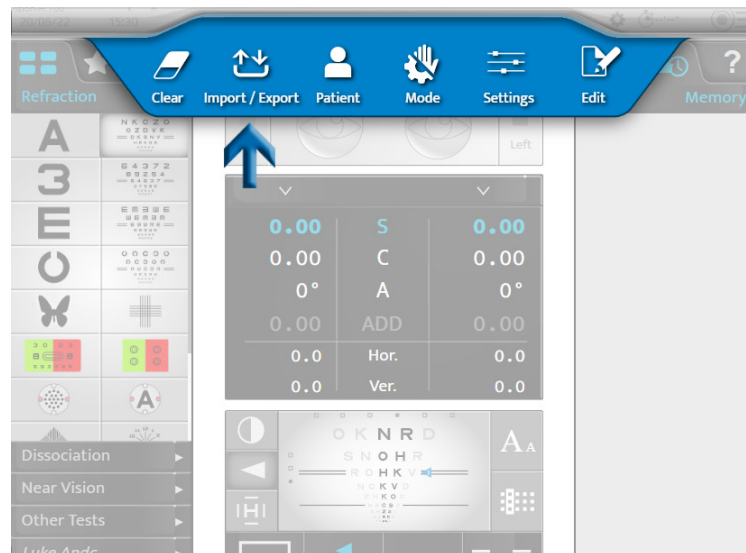

- On the console keyboard, by pressing on the [Import] .

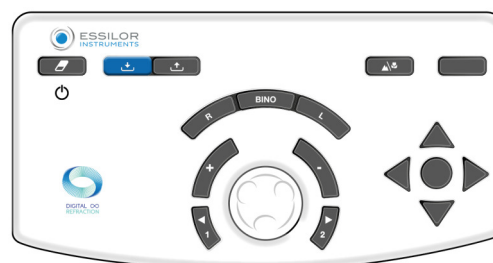

According to imported information and the phoropter settings, the refraction data is automatically placed in one of the memories of the phoropter:

- [Lensmeter]: previous correction
- [Autorefractor]: objective refraction measured with the auto-refractometer or the aberrometer
- [Retinoscopy]: refraction measured by skiascope/retinoscope
- [Computer]: refraction from the patient folder
- [Subjective night]
- [Auto-kerato-refractometer night]
- [Memory 1]
- [Memory 2]
- [Memory 3]
- [Memory 34]



10 memories are available in all.
 It is possible to rename the memories.

c. Manual entry

The entry of the starting refraction can be performed either:

- Eye by eye
- Two eyes at the same time

You can manually enter the patient's refraction data into the phoropter in two different ways:

1. By using the console touch screen, or
2. By using the console keyboard.

1 - Using the console touch screen

- 1 Press on the setting which you wish to enter.
 - Sphere (S)
 - Cylinder (C)
 - Axis (A)



The selection can be done independently for the right eye, the left eye or in binocular.

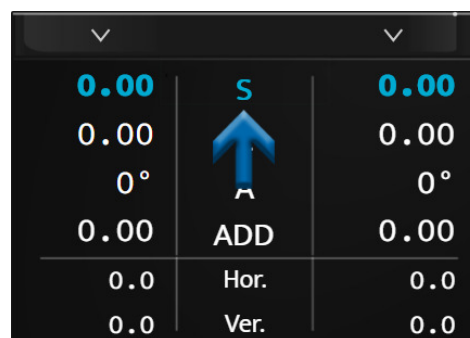

- > The line of the selected setting is displayed in blue. Press the selected parameter again to display the numeric keypad.

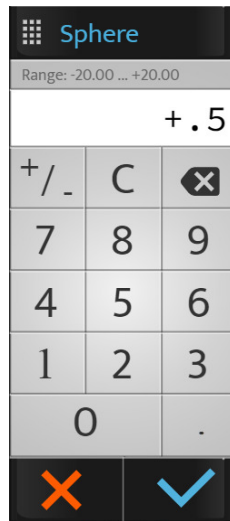

2 Enter the desired value and press:

- o ✓ to confirm.
- o ✗ to cancel.

- > The data is displayed on the screen and is applied in front of the eye or the eyes of the patient.

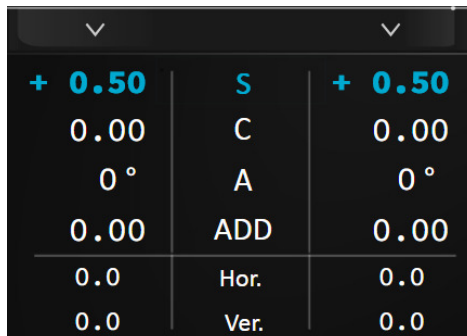

3 Then press on other settings if necessary.

2 - Using of the console keyboard

1 Press on the keys [R, BINO or L].

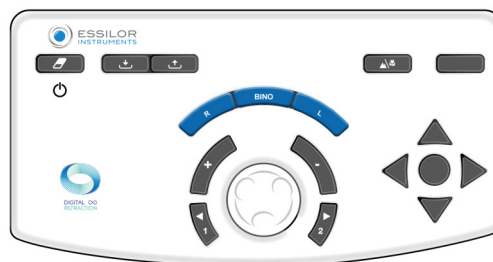

2 Turn the console keyboard's central button clockwise (-) or counterclockwise (+).

- > The values of the selected setting change.

3 Press on the central button on the keyboard to change the setting if necessary.



Do not forget to save the data entered in one of the available memories (here [Lensmeter]).

3 - Data memorization

1 Press:

0.00	S	0.00
0°	C	0.00
0.00	A	0°
0.0	ADD	0.00
0.0	Hor.	0.0
0.0	Ver.	0.0

> The list of the available memories is displayed.

Save		
Lensmeter		📄
Autorefractor		📄
Retinoscopy		📄
Computer		📄
Memory 1		📄
Memory 2		📄
Memory 3		📄
^	Convert	^
^	Adjust	^

- 2 Choose the desired memory.
 - > The saved data is displayed on the right part of the screen.



2. Standard tests

There are three types of standard tests:

1. The far-vision refraction tests
2. The binocular-vision tests
3. The near-vision tests

a. Refraction tests

The following refraction tests will be detailed:

- Visual acuity
- Red/Green or Duochrome
- Fixed cross cylinders
- Reserved cross cylinders
- Bi-ocular balance



This list is not exhaustive.

Some main tests are only detailed here to help understand operation of the instrument.



For each test, a contextual “in situation” help is available by pressing on **?**.

User is prompted to refer to this.



Reminder

Before performing the refraction tests, it is recommend to first enter the data of the patient’s initial refraction into the instrument.

This data can come from:

1. The previous measured refraction on the glasses of the patient,
2. The objective refraction:
 - measured with the auto-refractometer or a skiascope,
 - determined by an aberrometer.
3. The patient folder.

Visual acuity

Objective

Measure the visual acuity of the patient with and/or without correction in:

- Far vision,
- Monocular vision condition:
 - right eye (RE),
 - left eye (LE),
- Binocular vision condition (RLE i.e. RE and LE simultaneously).

Choice of optotypes scale

It is possible to choose two types of optotypes scales:

1. Rational progression scale (in opposite and decimal acuity)
 - letters
 - numbers
 - C of Landolt
 - E of Snellen
 - stylized figures
2. Logarithmic progression scale
 - letters
 - numbers
 - C of Landolt
 - E of Snellen

Once you have made your choice, press on the icon of the desired test. The visualization of the test is then displayed at the bottom of the main screen:





The test display area allows you to:

- Visualize the optotypes presented.
- Display the acuity values in the unit chosen during configuration:
 - decimal acuity (x/10)
 - Snellen acuity in meters (6/x)
 - Snellen acuity in feet (20/x)





The table of optotypes allows you to:

- Display the value of corresponding acuity,
- Display the unit of acuity.

Choice of optotypes scale

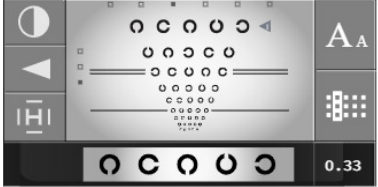
Scales of acuity	Types	Icons	Display zone at the bottom of the screen
Rational progression scale	letters		
	numbers		
	C of Landolt		
	E of Snellen		
	stylized figures		
Logarithmic progression scale	letters		
	numbers		

	C of Landolt		
	E of Snellen		



So that the patient does not memorize the series, for each scale of acuity, six series of optotypes are available. You can change the series while maintaining the same letter size:

- On the touch screen, by pressing on the points above the optotypes.

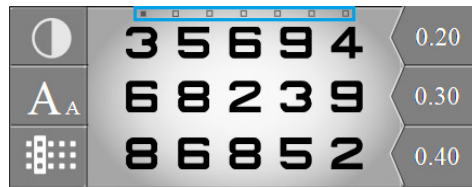

- On the console keyboard, by pressing on the horizontal keys.

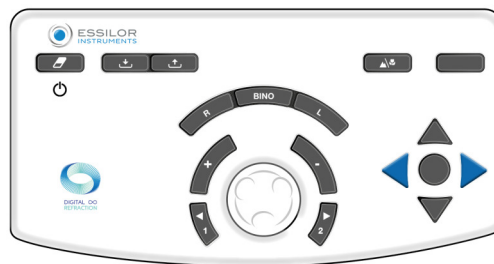

Display of the visual acuity values

To display acuity values, press on **A_A**.

The acuity values are displayed below the table with the visual acuity value(s) currently being presented highlighted in blue.

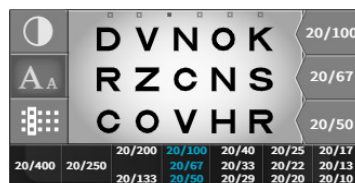

You can change the visual acuity values on the console keyboard by pressing on the vertical keys:



Record the patient's acuity value by pressing the key in the middle of the four arrows or by pressing on the acuity value on the screen.

On keyboard	On screen



Choice of optotype table display

To choose a kind of display press on .

It is possible to choose four display types of optotypes:



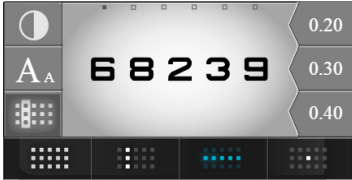

1. In table
2. In column
3. In line
4. In isolated optotype

Display types	Display in zone at the bottom of the screen
Table	
Column	
Multiple column (press on the same icon again)	

Line	
Multiple line (press on the same icon again)	
Isolated optotype	

Fix patient focus

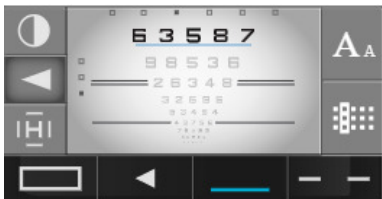
In this section, the ECP can fix the focus of the patient on a specific area. Press . Now it is possible to focus from:

Arrow	
Block	
Underline	
Opposite lines	

Choice of contrast type

To choose a type of contrast, press on .

It is possible to choose three types of contrasts:

1. Red-green, in 100% contrast,
2. White on black background
3. Black on white background, with choice of contrasts from 0 to 100%.



Procedure - Determine the visual acuity of the patient

- 1 Select the optotypes on the touch screen.
 -  Check that the optotypes that appear correctly on the test presentation screen.
- 2 Select the right eye, the left eye or both eyes by using the keys [R, L or BINO] on the console keyboard.



- 3 Scroll through the acuity tests using the vertical arrows on the console keyboard.



- 4 Ask the patient the following question:
 “Look at the test, what is the smallest symbole line that you can make out without squinting?”
 - > If the patient manages to make out 3 out of 5 optotypes on the same line of acuity, the level of acuity is considered as achieved.
- 5 Save the visual acuity value. You can save this value:
 - o On the console keyboard, by pressing on the key located in the middle of the 4 arrows.

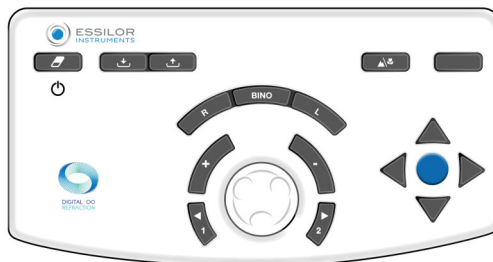

 Only for rational scale if a line or a symbol is isolated.

- On the touch screen, by pressing on the acuity value appearing in the display area.



- > The value of the visual acuity of patient (RE, LE or BINO) changes into blue and is saved in the section “Patient Data”, in the memory “Visual Acuity”.
- > It appears in the dial on the right of the screen.

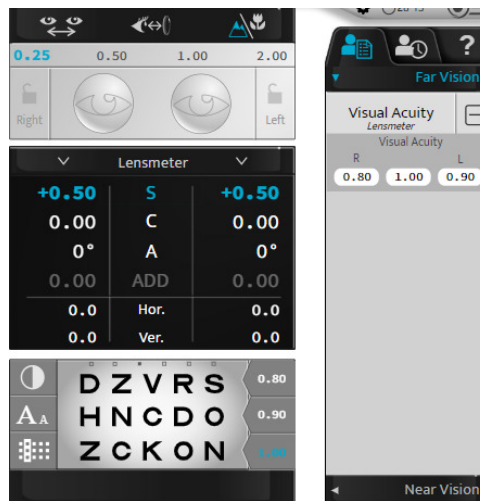

Red/Green or Duochrome (non-smart test).

Objective

Adjust the patient's spherical correction value in:

- Far vision,
- Monocular vision condition:
 - right eye (RE),
 - left eye (LE),
- Binocular vision condition (RLE i.e. RE and LE simultaneously).

Procedure - Performing the test

1 Press .

> The Red/Green test is displayed in the display area in the bottom of the touch screen of the console.



> The corresponding table of optotypes is displayed on the test presentation screen.



To perform this test in the best conditions, a more softly lit environment is advised.

2 Ask the patient the following question:

“Look at the test, do the characters seem clearer in the green background, on the red background or do they appear identical on both backgrounds?”

If the answer is:

- > - **clearer on the red background** add -0.25 D (*) to the value of the sphere. Either:
 - o On the console keyboard, by pressing on the key " - ".

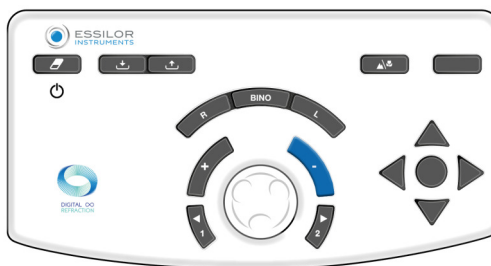

- o On the console keyboard, by turning the central button clockwise (*).

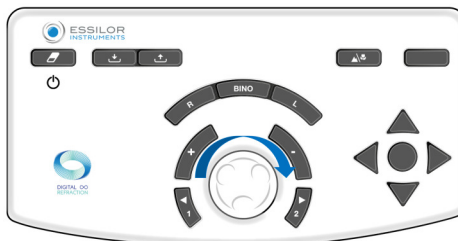

- > Start the test again until the patient sees the equal blackness for the characters on the red background and the green background or the preference for the green background.
- > - **clearer on the green background** add +0.25 D (*) to the value of the sphere. Either:
 - o On the console keyboard, by pressing on the key “+”.

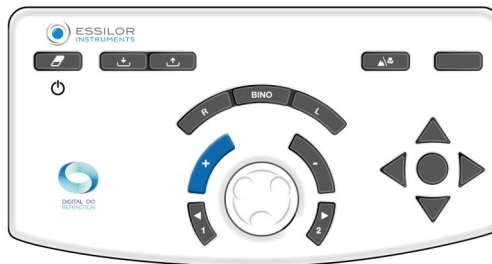

- o On the console keyboard, by turning the central button anticlockwise (*).

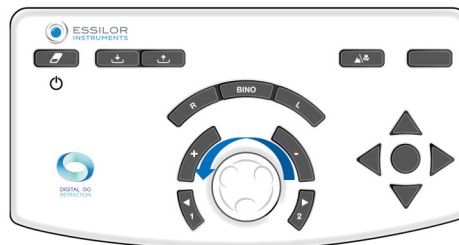

- > Start the test again until the patient sees the equal clarity for the characters on the red background and the green background or the preference for the red background.
 - > - **identical on the red background and the green background** retain this sphere value.
- In the event of preferred red and green inversion between two sphere steps, retain the last values:
- o **red** for a patient **with myopia**
 - o **green** for a patient **with hypermetropia**

Notes

- To avoid the disturbing effects of the accommodation of the patient (which can make him prefer the red), it is possible to:
 - o ask the patient to look on the green background before proceeding to the red/green comparison,
 - o lightly blur by adding a power of +0.50 D in order to obtain a preference for the red and to then clear it up until obtaining the balance between the red and the green.
- Several successive preferred answers for the red can indicate that the patient unintentionally involves his accommodation. This can occur in particular with young patients who can be sometimes appear short-sighted by the excessive inclusion of their accommodation. It is thus important to make sure not to let it result in a too concave (or negative) sphere value.



(*)

This information corresponds to the phoropter default settings. The **sphere variation step is by default 0.25 D** but can be adjusted in settings.

Fixed cross cylinders

Objective

Adjust the patient's spherical correction value in:

- Far vision,
- Monocular vision condition:
 - right eye (RE),
 - left eye (LE),
- Binocular vision condition (RLE i.e. RE and LE simultaneously).

Procedure - Performing the test

1 Press .

- > A cross made up of black horizontal and vertical lines on a white background is displayed in the display area at the bottom of the touch screen on the console.



- > A cross is displayed on the test presentation screen.
- > A fixed cross cylinder with a "+0.50 (- 1.00) 90°" formula is added to the patient's correction (on the right eye, the left eye or both eyes).



This cylinder is **automatically** generated by the optical module through combination with the patient's correction. It is not an additional lens added in front of the correction of the patient (as in the traditional phoropters).

2 Ask the patient the following question:

“Look at the cross. Tell me if the horizontal or vertical lines appear clearer to you or darker or if they have the same darkness.”

If the answer is:

- > - **clearer vertical lines** add -0.25 D (*) to the value of the sphere. Either:
 - o On the console keyboard, by pressing on the key “-”.



- o On the console keyboard, by turning the central button clockwise (*).



> Start the test again until the patient sees equal clearness between the horizontal and vertical lines or a greater clearness for the horizontal ones.

- > - **clearer horizontal lines** add +0.25 D (*) to the value of the sphere. Either:
 - o On the console keyboard, by pressing on the key “+”.

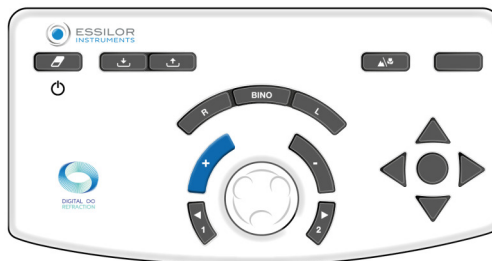

- o On the console keyboard, by turning the central button anticlockwise (*).

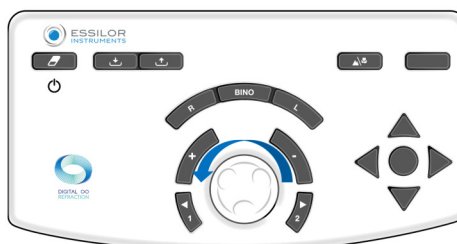

- > Start the test again until the patient sees equal clearness between the horizontal and vertical lines or a greater clearness for the vertical ones.
 - > **- equality of darkness between the horizontal and vertical ones** retain this sphere value.
- In the event of preferred inversion between the horizontal and vertical lines between two sphere steps, retain the last values:
- **vertical** for a patient **with myopia**
 - **horizontal** for a patient **with hypermetropia**

Notes

- To avoid the disturbing effects of accommodation, it is possible to blur the patient (with a convex power) until you obtain the preference for the vertical lines and to then clear up it until you achieve a balance between the horizontal and vertical lines.
- The test of the fixed cross cylinders supposes an exact correction of the astigmatism of the eye. The result can be distorted if a direct astigmatism (cylinder axis further from 0°) or the opposite (cylinder axis further from 90°) is over or under-corrected.
- At the end of the test, the horizontal and vertical lines are slightly fuzzy (because the patient looks at them through a cylinder of 1.00 D). The important thing is that the blurring is identical on the horizontal and vertical lines.



(*)

This information corresponds to the phoropter default settings. The **sphere variation step is by default 0.25 D** but can be adjusted in settings.

Reserved cross cylinders

Objective

Determine the value of the patient's cylindrical correction:

- Axis,
- In power,
- In far vision,
- In single-eyed vision (right eye or left eye).



Historically, the reserved cross cylinders test was performed using a lens made up of a positive cylinder and a negative cylinder of the same powers and perpendicular portions between them. This lens was mounted on a shaft and allowed the position of positive and negative cylinders to be manually reversed by turning the lens over itself.



Unlike traditional manual and automated phoropters, there is no reversal in the Vision-R™ 700 or "changing" lens manuals. The cross cylinder move positions instantaneously. It is determined by a calculation which, in combination with the correction in place, is directly generated by the optical module. The patient sees a change occurring instantly and without interruption and thus perceives differences more easily.

Principle

The principle of the test is to combine the astigmatism of the lens with the uncorrected residual cylinder value of the eye (the one resulting from the combination of the eye's astigmatism and the correction in place).

- If the astigmatism is properly corrected, the patient does not perceive any difference between the positions of the cross cylinder. They are seen as equally blurred.
- If the astigmatism is not perfectly corrected, the patient perceives a blurring difference between the different positions of the cross cylinder.

The reversed cross cylinder test takes place in three stages:

1. Cylinder axis search
2. Cylinder power search
3. Sphere power adjustment (based on the cylinder value)



Reminder - cylinder axis search

The search for the cylinder axis consists of comparing two positions:

1. The negative axis of the corrective cylinder
2. The cylinder axis of the patient correction

If the axis of the correction is correct, the patient does not perceive any difference between the two positions.

However, if the patient perceives a difference between the two positions, the correction axis must be adjusted by 5° (*) in the direction of the negative axis of the preferred cross cylinder. The operation must be repeated until the patient no longer perceives a difference between the two positions or indicates a return to the previous axis position.



Reminder Cylinder power search

The search for the cylinder power consists of positioning the meridians of the cross cylinder according to the direction of the axis of the correction and comparing the two positions of the cross cylinder.

If the power of the cylinder is correct, the patient does not perceive a difference.

However, if the patient perceives a difference it is necessary to modify the power of the cylinder. If the patient prefers:

- The position of the cross cylinder with the negative axis aligned with that of the correction: it is necessary to **increase** the negative cylinder value of the correction by 0.25 D (*).
- The position where the negative axis of the cylinder is perpendicular to the axis of the correction (corresponds to the positive cylinder axis aligned with that of the correction): it is necessary to **reduce** the cylinder value by 0.25 D (*).

Repeat the operation until the patient no longer perceives a difference or indicates a return to the previous position of the cross cylinder.

Note: after a change of 0.50 D to the cylinder, do not forget to adjust the sphere power of 0.25 D in order to maintain the constant equivalent spherical power.

Procedure - Test Performance, Step 1 Cylinder Axis Search

- 1 Press

This test can also be performed with a letter target

- > The reversed cross cylinder test is displayed in the display area in the bottom of the touch screen of the console.



- > The dot test is displayed on the test presentation screen.
- > The cross cylinder is placed in the cylinder axis verification position, oriented according to the direction of the negative axis of the patient's correction cylinder.
This axis is visually represented by the black line below.



The white dots represent the positive axis.



It is also possible to place it directly in the axis search position by clicking once on the value of the cylinder axis for the eye concerned.

0.00	S	0.00
0.00	C	0.00
0°	A	0°
0.00	ADD	0.00
0.0	Hor.	0.0
0.0	Ver.	0.0

2 Ask the patient the following question:

"Look at the dots. Tell me if they look sharper, darker, more contrasted in position 1, position 2 or if they look identical to you?"



To:

Show the dots in position 1, press the "1" key on the console keyboard.

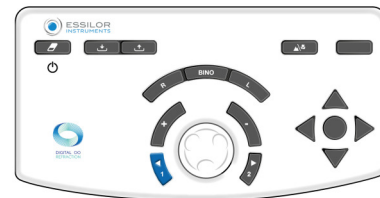

To show the dots in position 2, press, press the "2" key on the console keyboard.



It is important to always propose the three options:

- o Position 1
- o Position 2
- o Same

> The position change appears in the test presentation area in two ways:

Blue highlighting of positions 1 and 2	Cross cylinder position change



Reminder:

- The red points mark the negative axis of the cross cylinder
- The white points mark the positive axis of the cross cylinder

If the answer is:

- > - **clearer in position 1**, press the + key on the console keyboard:



The axis (the negative cylinder of the correction and the cross cylinder) rotate in the direction of the negative axis of the patient's preferred position (*).

> Repeat the test until the patient no longer sees any difference between the two positions in the cross cylinder.

- > - **clearer in position 2**, press the + key on the console keyboard:

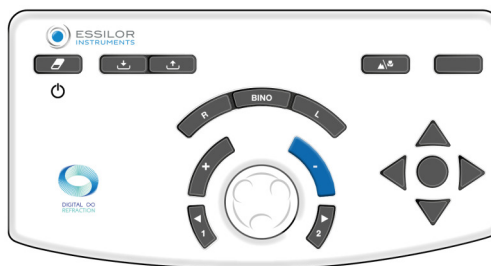

The axis (the negative cylinder of the correction and the cross cylinder) rotate in the direction of the negative axis of the patient's preferred position (*).

> Repeat the test until the patient no longer sees any difference between the two positions in the cross cylinder.

- > - **no difference**, press on the keyboard's central button on the console:

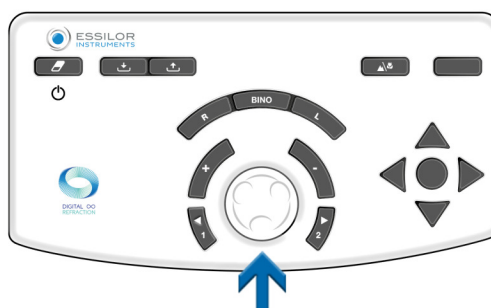

> Retain this value for the cylinder axis.

- > The refraction head then is automatically set up in the cylinder power verification position.

If you prefer to reverse position 1 to position 2, hold the first value of the axis or a middle value. Validate it using the central button on the console keyboard.

Notes

If no starting cylindrical correction is available, first locate the cylinder axis on a range of 45° by comparing positions 0° and 90°, then 45° and 135°.

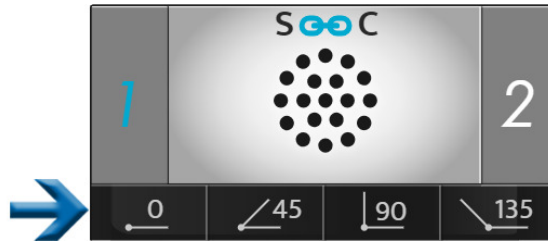

It will be necessary to place a negative cylinder of -0.50 D in the specified range of 45° and then perform the above procedure.



(*)

This information corresponds to the phoropter default settings.

- The **no change in cylinder axis is by default 5°** but can be adjusted in settings.
- It can also be modified during the examination by selecting it in the steps display area.



Procedure - Test run, step 2 cylinder power search

- 1 Select the power of the cylinder. Either:
 - On the console keyboard, by pressing on the central button.

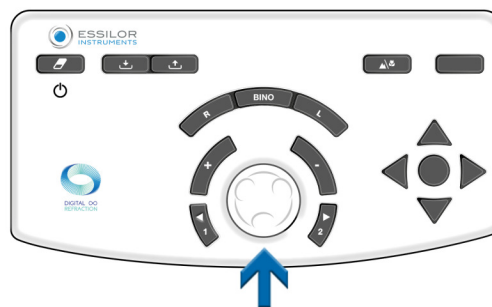

- On the touch screen of the console, by clicking once on the setting value of the particular eye.

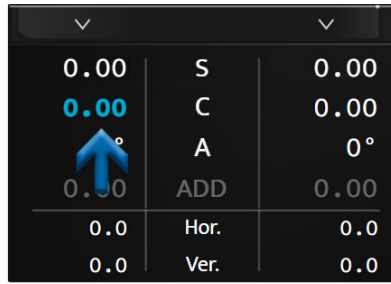

- > The cross cylinder is positioned in the power verification position of the cylinder, oriented according to the direction of the negative axis of the corrective cylinder for the patient correction.



It is turned 45° from its position when searching for the cylinder axis.

- 2 Ask the patient the following question:

"Look at the dots. Tell me if they look sharper, darker, more contrasted in position 1, position 2 or if they look identical to you?"



To:

Show the dots in position 1, press the "1" key on the console keyboard.

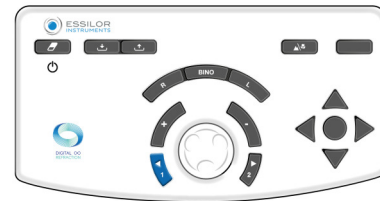

To show the dots in position 2, press the "2" key on the console keyboard.

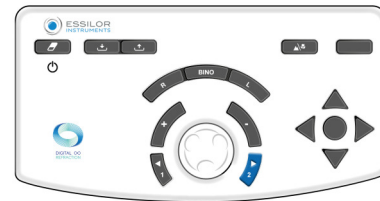

It is important to always propose the three options:

- o Position 1
- o Position 2
- o Same

- > The position change appears in the test presentation area in two ways:

Blue highlighting of positions 1 and 2	Changing of cylinder axis position



Reminder:

- The red points mark the negative axis of the cross cylinder
- The white points mark the positive axis of the cross cylinder

If the answer is:

- > - **clearer in position 1**, press the + key on the console keyboard:



The negative cylinder value of the correction is then reduced by +0.25 D.

> Repeat the test until the patient no longer sees any difference between the two positions in the cross cylinder.

- > - **clearer in position 2**, press the + key on the console keyboard:

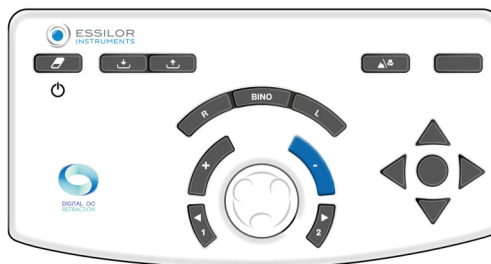

The negative cylinder value of the correction is then increased by -0.25 D.

> Repeat the test until the patient no longer sees any difference between the two positions in the cross cylinder.

- > - **no difference**, press on the keyboard's central button on the console:

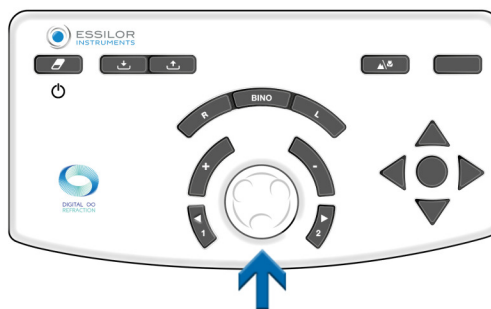

> Retain this value for the cylinder power.

If preferably reversed between position 1 and position 2, retain the lowest value of the two cylinder values found.



(*)

This information corresponds to the phoropter default settings.

- The variation step of the cylinder power is by default 0.25 D, but it can be adjusted in the settings.
- It can also be modified during the examination by selecting it in the steps display area.



Procedure - Test run, step 3 sphere power adjustment

1 Adjust the sphere value to maintain the constant spherical equivalent.



Perform this operation in case two power step variations have been made.

Example: if -0.50 D cylinder has been added, the sphere should be adjusted by +0.25 D (*).

2 This adjustment, by correction of the sphere, is manual. You can do it:

- On the console keyboard, by pressing on the central button.

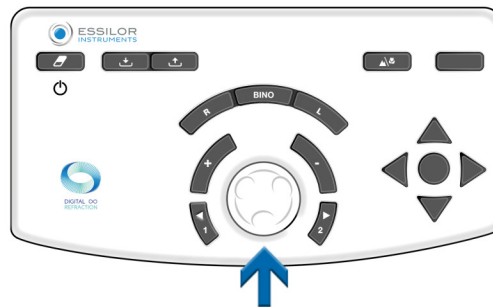

- On the touch screen of the console, by clicking once on the setting value of the particular eye.

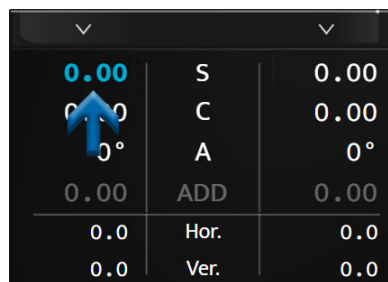

(*)

If the variation step in the cylinder power was chosen at a value other than 0.25 D, the automatic adjustment of the sphere power will also occur after two variation steps in the cylinder.

For example: if the pitch is 1.00 D, the sphere value will be corrected by +1.00 D after a change in cylinder power of -2.00 D.

Bi-ocular balance

Objective

Adjust the equilibrium of corrections between the right and left eye in a bi-ocular vision condition (both eyes open but simultaneously perceiving different targets).

Principle

The principle of the test is to slightly blur the patient's vision by introducing a power of +0.50 D (or +0.75 D) in front of both eyes to make it easier to compare the vision of the right eye and the left eye.



It is easier to compare two fuzzy visions to two sharp ones.

If the patient sees more clearly with one eye than with the other, blur the eye that sees the best, increasing the power by +0.25 D so as to obtain a blurred vision balance between the two eyes.

Once the equilibrium has been achieved, remove the previously introduced +0.50 D (or +0.75 D) power and retain the power, if any, added on one of the two eyes.

Note

The practice of bi-ocular equilibrium testing assumes that the visual acuity of both eyes is identical or similar.

In the case of significantly different visual acuities between the right and left eye, a polarized red/green test or a vertical prism dissociation test should be used. It will allow the patient to simultaneously take a different red/green test for each eye. It will then be possible to simultaneously search for red/green equality for each eye, with both eyes open.

Procedure - Performing the test

1 Press .

> The bi-ocular equilibrium test is displayed in the display area at the bottom of the touch screen of the console.



> The polarized filters are placed in front of the patient's eyes so that the vision is separated from the eyes.

> Masks are displayed .

- > Two polarized letter lines appear on the test presentation screen.



The patient can see:

- o The upper line with the right eye (*)
- o The bottom line with the left eye (*)

- 2 Insert the +0.50 D (or +0.75 D) power in front of both eyes (so as to slightly blur the patient's vision).



You can introduce the power in two ways. By pressing [Bino] and then (once the "S" parameter is selected):

1. By turning the center button counterclockwise twice (+0.50 D) or three times (+0.75 D).

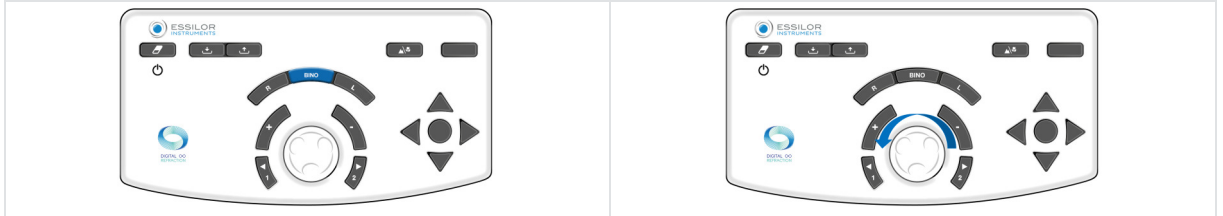

2. By pressing the "+" key twice (+0.50 D) or three times (+0.75 D).



- 3 Ask the patient the following question:

"Look at the two lines of letters. Tell me if the letters look clearer on the top line, on the bottom line, or if they look identical to you?"

If the answer is:

- > - **sharper letters on the top line**, add +0.25 D (*) to the value of the sphere on he right eye. To do this:
Press the [R] key on the console keyboard.

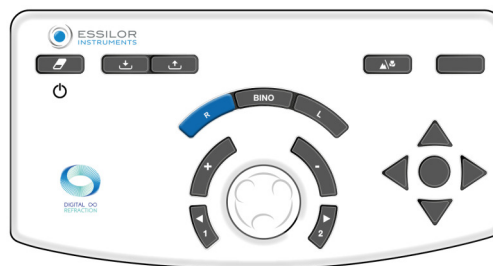

On the console keyboard:

- o Press the "+" key.

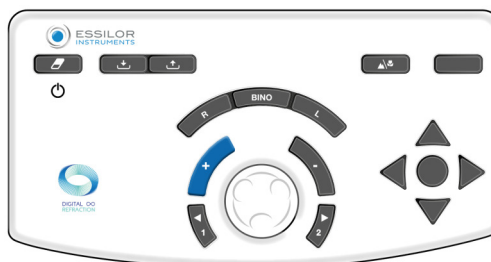

- Or, turn the center button counterclockwise (*).



> Repeat the operation until the patient sees a balance in the blurred vision between the top and bottom lines or its reversal.

- > - **sharper letters on the bottom line** add +0.25 D (*) to the value of the sphere on the left eye. To do this: Press the [L] key on the console keyboard.

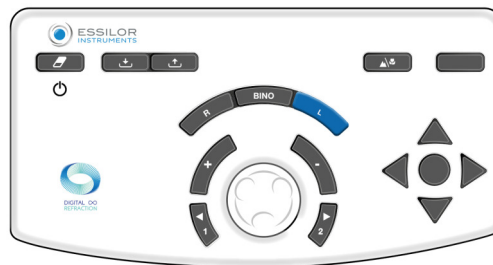

On the console keyboard:

- Press the "+" key.

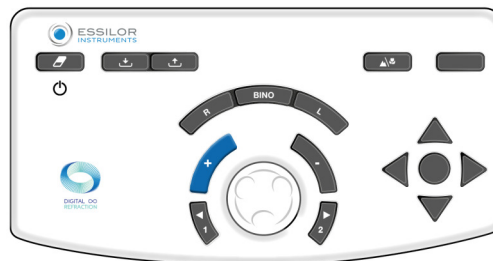

- Or, turn the center button counterclockwise (*).

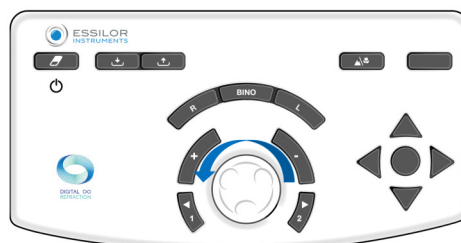

> Repeat the operation until the patient sees a balance in the blurred vision between the top and bottom lines or its reversal.

> - **identical letters on top and bottom lines**, bi-ocular equilibrium is achieved. Note this value.

In case of preferred inversion between the top and bottom lines between the proposals:

- Reduce the gap in the variance step to determine the exact bi-ocular equilibrium or
- Keep the balance that gives preference to the dominant eye of the patient.



The dominant eye of the patient is determined during preliminary refraction tests.

4 Once bi-ocular equilibrium has been achieved, remove the +0.50 D (or +0.75 D) powers introduced at the beginning of the test.



You can remove the power in two ways. By pressing [Bino] and then (once the "S" parameter is selected):

1. By turning the center button clockwise twice (+0.50 D) or three times (-0.75 D).

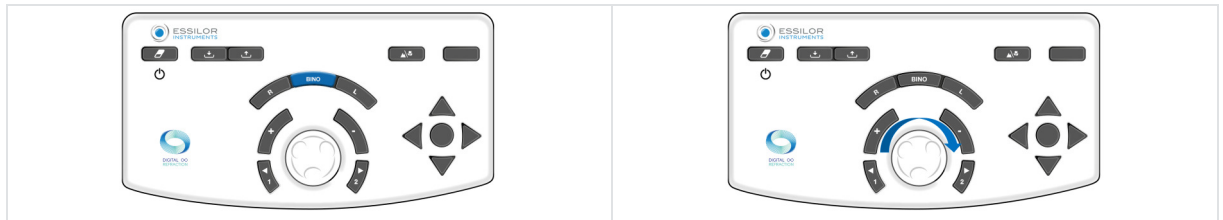

2. By pressing the "-" key twice (-0.50 D) or three times (-0.75 D).



Following the bi-ocular equilibrium test, perform a binocular sphere check with the red/green test (to be performed with both eyes open).

Notes

- If the patient reports that the lines appear and disappear or shift horizontally or vertically, he is likely to have a binocular vision problem (difficulty simultaneously viewing or merging images).
- It is worthwhile to ask the question routinely at this stage of the test in order to ensure that the patient has simultaneous vision in both eyes and that the patient's vision is stable.



(*)



This information corresponds to the phoropter default settings. The **sphere variation step is by default 0.25 D** but can be adjusted in settings.

b. Near vision tests



Near vision tests to be performed with rod and near point chart.

3. Smart tests

 A smart test is a semi-automatic test using an algorithm that can determine more precisely the subjective refraction of the patient. At the time of a smart test, all the answers are saved and integrated automatically in order to prescribe the best possible correction.

 The smart tests are identifiable through a pictogram located on the right of the icon .

 Some main tests are only detailed here to help understand operation of the instrument.

 For each test, a contextual “in situation” help is available by pressing on .

 All the smart tests function are based on the principle of inserting patient answers and the progression of the algorithm to determine the checked setting. And this, until the right value is found.

a. Refraction tests

Red/Green or Duochrome smart test

Objective

Refine the patient's spherical correction value in:

- In far vision,
- Monocular vision condition:
 - right eye (RE),
 - left eye (LE),
- Binocular vision condition (RLE i.e. RE and LE simultaneously).

Procedure - Performing the test

1 Press .

- > The test view window in the bottom of the touch screen of the console allows you to choose under which conditions the test will be performed (RE, LE, Bino).



- 2 Once the condition is selected, start the test.
 - o On the touch screen by pressing on [Start].



- o On the console keyboard, by pressing on the central button.



- > The Red/Green smart test is shown in the display area in the bottom of the console's touch screen.



The center part of the screen appears grayed out. It is no longer possible to modify the values of controlled settings, the masks, the filters or the adjustments of the instrument.

- > The corresponding table of optotypes is displayed on the test presentation screen.

- 3 Ask the patient the following question:

“Look at the test and tell me if the characters appear darker to you or more contrasted on the red background, on the green background or if they seem identical to you.”

If the answer is:

- > - **darker on the green background.** Select the answer by either:
 - o Pressing on the corresponding answer on the touch screen.

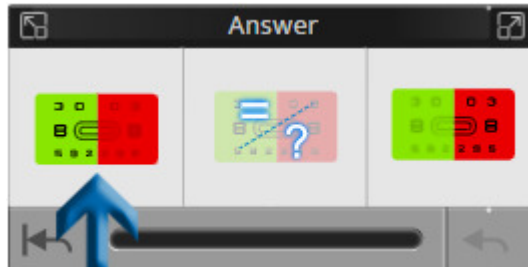

- o On the console keyboard, by pressing on the key “+”.



- > - **darker on the red background.** Select the answer by either:

- o Pressing on the corresponding answer on the touch screen.

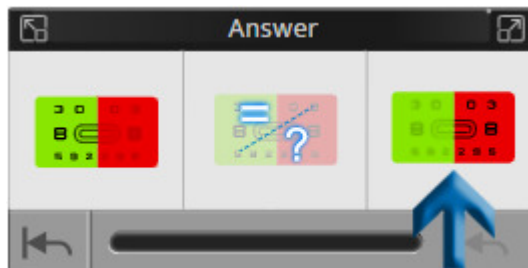

- o On the console keyboard, by pressing on the key “-”.

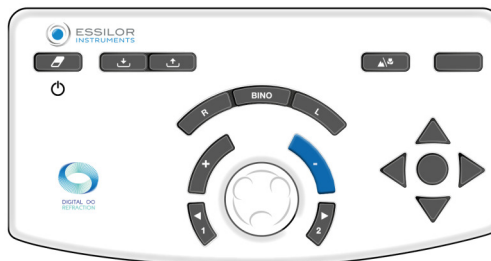

- > - **no preference, doesn't know**. Select the answer by either:
 - o Pressing on the corresponding answer on the touch screen.



- o On the console keyboard, by pressing on the central button.

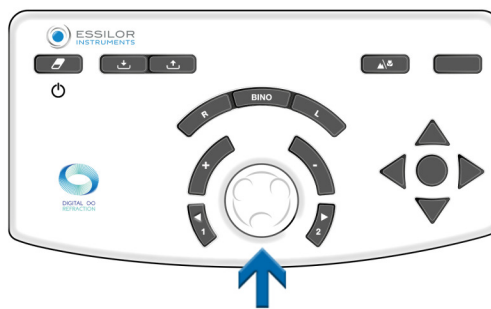

The response window also allows for:

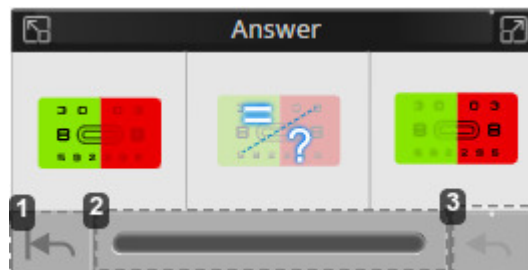

1. *Return to the beginning of the test*
2. *Visualize the progress of the test*
Three status indications on the progression bar are available.
3. *Cancel the last answer*



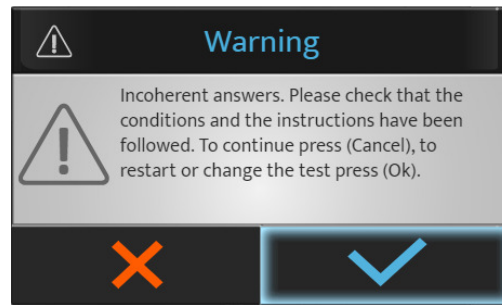

An error message may appear, if there is an anomaly during the test.

EXAMPLE:



Press:

-  to stop or start the test again.
-  to continue the test.

- 4 Select the following test on the touch screen by pressing on the desired test in the available list.



In the case of a test program, moving to the following test is done when link is deactivated:

- On the touch screen by pressing on [Next].

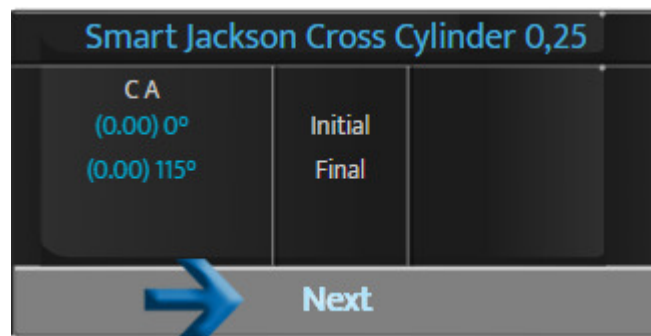

- On the console keyboard, by pressing on the central button.

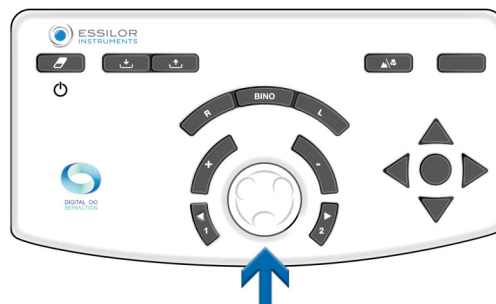

The "next" option will only appear if the link is deactivated on the smart test.



If the link is activated, the next test will be launch automatically.

4. Refraction comparison (Bluetouch)

The access to the comparison screen can be done:

- On the console keyboard, by pressing the comparison button.

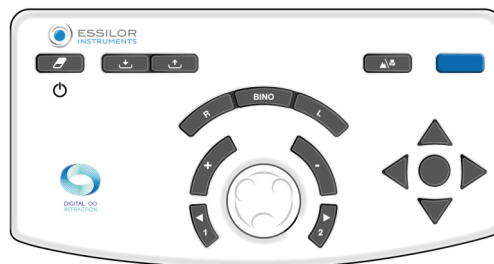

- With the action button which can be set up in a personalized test.

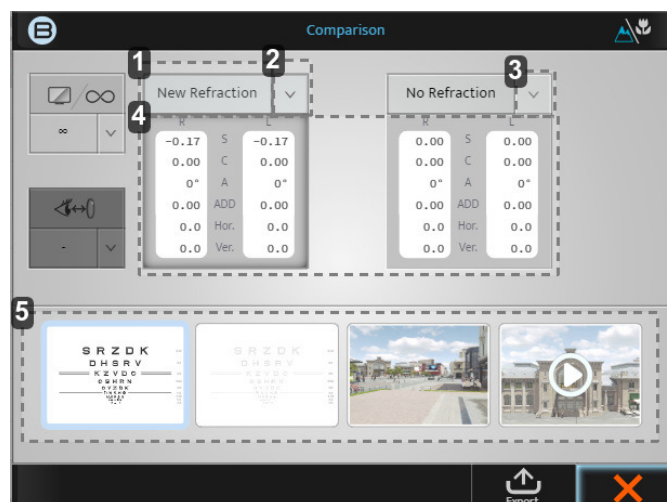
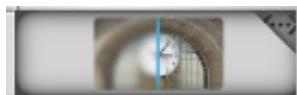

1. [New refraction] tab

This value will give the refraction done last and if you press on the block those powers will be displayed.

2. Down arrow

Clicking on the down arrow will allow you to select other saved data to compare, such as:

- Lensmeter
- Auto-Kerato-Refractometer
- Etc

3. Down arrow

Clicking on the down arrow will allow you to select other saved data to compare, such as:

- Lensmeter
- Auto-Kerato-Refractometer
- Etc

4. Datas

If you click on the grey block itself, the power in the phoropter will change to those values.

5. Display windows

The 4 display windows will allow you to change the screen being viewed, comparing from log-MAR to 3D, and video.



Once you know what data you want to compare to which image it is always best to switch between the two datas repeatedly and ask the patient which they prefer.

Example: How to compare new refraction vs previous refraction

- 1 Once the datas are updated, click on:



or,



> The following screen appear:



On the initial screen, the default comparison values are [New refraction] and [No refraction]. As you had a lensmeter value in the memory bank, it will automatically have these two comparisons already selected.

For this example you will need to change the [No refraction] to [Lensmeter].

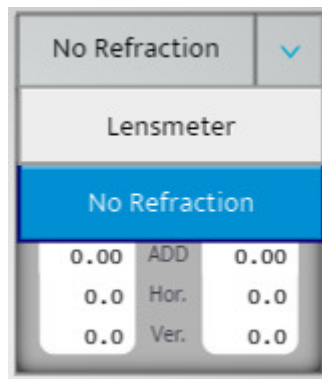

- 2 After selecting the screen to do the comparison on, you can alternate between the two prescriptions by clicking on the two grey boxes.
- 3 Ask the patient whether they see a difference when comparing the two values. (The patient should prefer the new refraction).
- 4 You can inform the patient that when you select the new refraction, this is how he/she will see with their new spectacles and that he/she should be able to see the improvement.

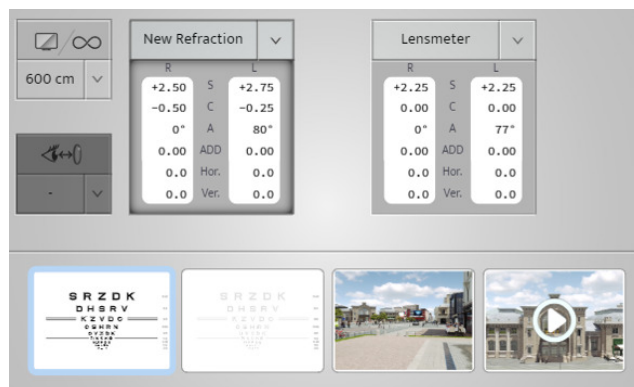

This is way we call it the “money button” >It converts your refraction into a sale by showing to the patient the difference he will see.

a. Alert function in the comparison screen

The “Alert function” has been developed to assist the ECP to be aware if there are any significant changes from the patients' previous information. This auto alert function is an option, which can be activated and personalized in the [Setting] menu.

When activated, this alert will appear in red as shown in the image below.



Note that this function can be activated, deactivated or personalized in the following [Setting] screen.

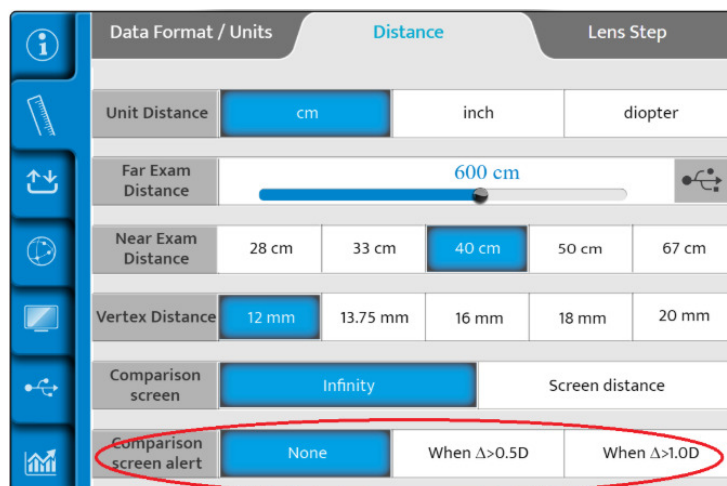

When activated, the ECP can decide whether to see this “Alert” when the dioptric difference is greater than 0.50 D or when greater than 1.00 D.

VIII. MEASUREMENT

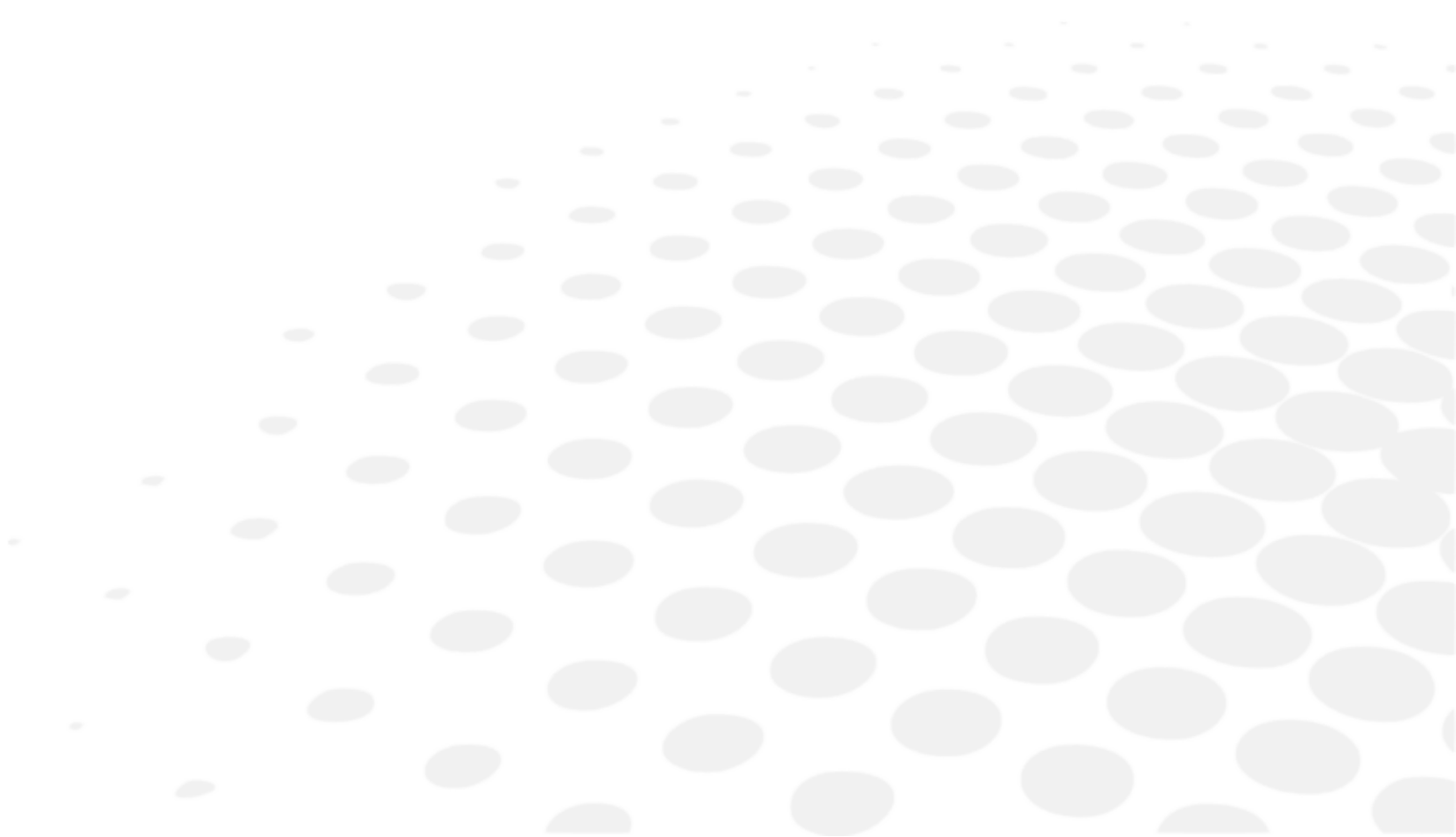

1. Vertex distance measurement



The “Vertex Distance” is the distance from the back side of a correcting ophthalmic lens (at the rear surface) to the patient’s eye (at the apex of the cornea). The Vertex distance has always been of importance in refraction since the refraction value of an eye depends on the distance at which the corrective lens is located in front of the eye. Indeed, the further away the lens from the eye, the more minus the corrective power; the closer the lens to the eye, the more plus the power, whatever the ametropia.

Measuring the Vertex distance could be very important

- If the patient is set up and tested at a different distance compared to the Vertex distance of the spectacles, the power change could have an effect on the performance of the spectacles.
- This is even more evident on higher powers

Measurement procedure

- 1 Ask the patient to position himself/herself behind the phoropter and rest their head against the forehead support while looking into the distance at the chart screen.
- 2 The practitioner checks that the phoropter is located close enough to the patient eye's, so as to offer a wide field of vision, but far enough to avoid the patient's eyelashes to be in contact with the back side window of the optical module.
- 3 The distance can easily be adjusted by using the rotating button located in front side of the Vision-R, turning it clockwise to reduce the Vertex distance and anti-clockwise to increase it.



- 4 The patient is then asked to look at distance and open the eyes widely. The practitioner press on the Vertex distance icon located at the top of the console screen.



- 5 The two cameras capture images of the eyes which is displayed on the console.

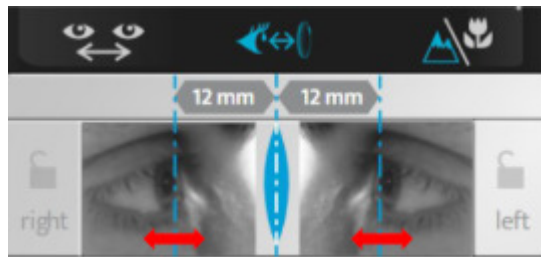

- > Two vertical lines appear on the images and the practitioner just has to align them with the apex of the cornea, either binocularly or minocularly.

On the console keyboard:

- o by turning the central button clockwise or counterclockwise, or

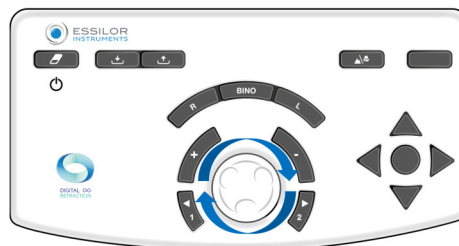

- o by pressing on the keys [+/-].



- > The value(s) of the Vertex distance(s) are automatically displayed and can then be recorded. A Vertex distance of 10 to 20 mm is appropriate.

IX. REFRACTION PROGRAMS

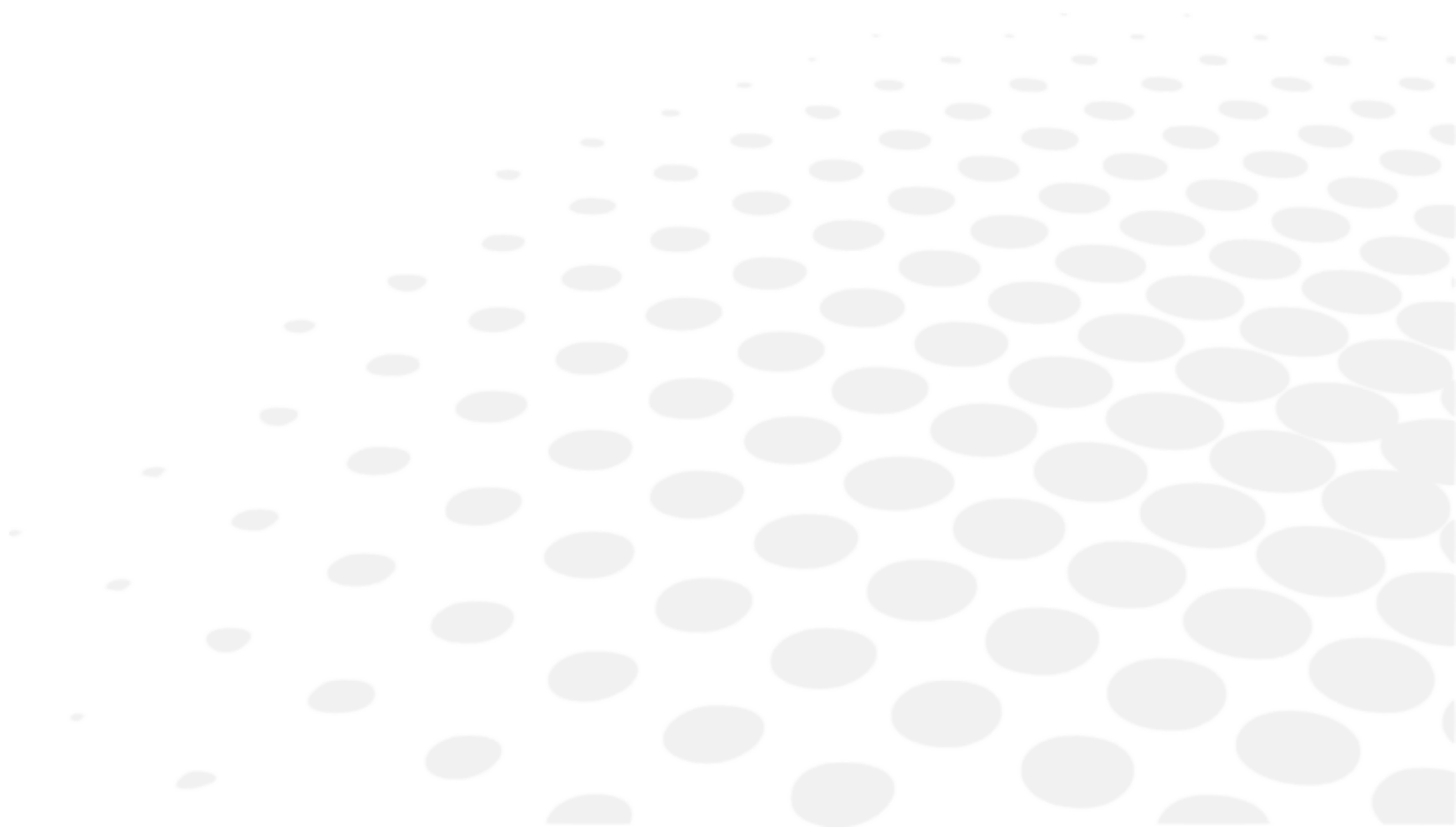

1. Standard programs

A standard program "Semi-Auto refraction" exist by default on the Vision-R™700.

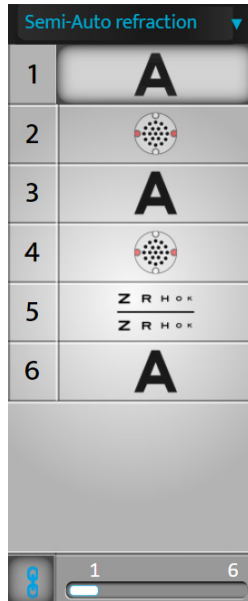

In this program, only standard tests are available (no smart test).

If the auto-link is activated, at the end of a test, press the middle button to jump automatically to the next test.



In the rational scale, this fonction is available only if isolated line or symbols.

2. Customized programs

a. Editing and customizing programs and tests

Customize program

The Vision-R™700 allows you to personalize your test sequence (program).



Personalizing a program refers to the program itself and not the detail within the test.

1 Press on  > .

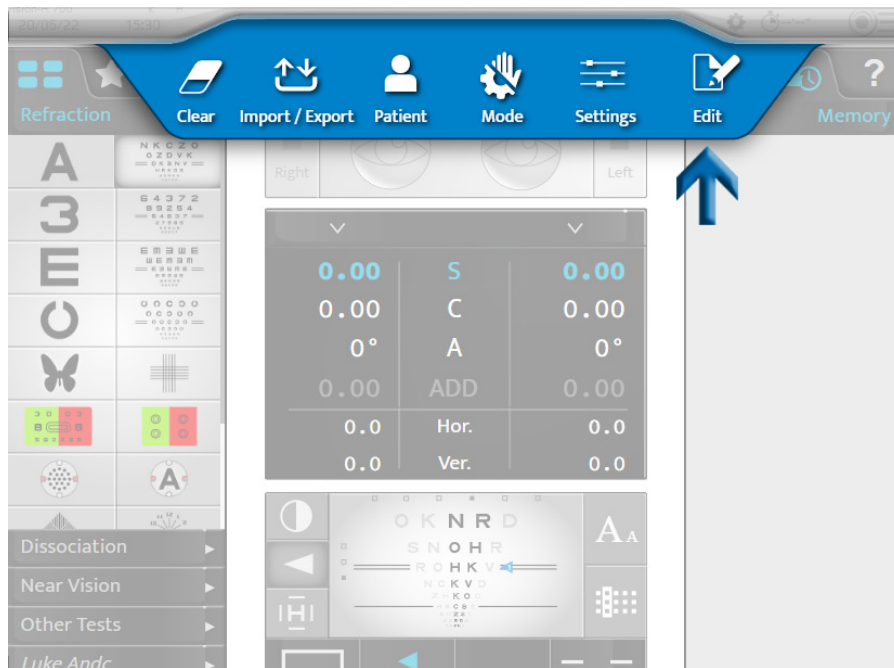

2 Click on  and click on [+] to create a new program.



> The following page appears:

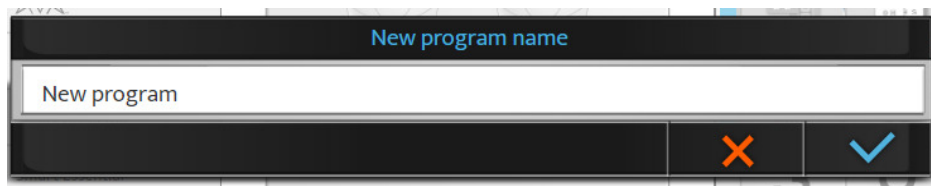

By default, the name is [New program]. At this stage, it is possible to modify the name of the program.

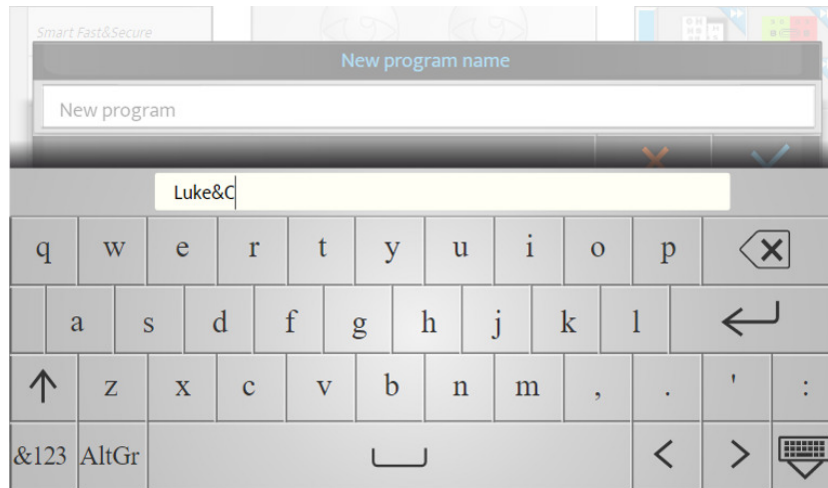

3 Name the program and click on .

> The new program appears in italics in the list of programs.

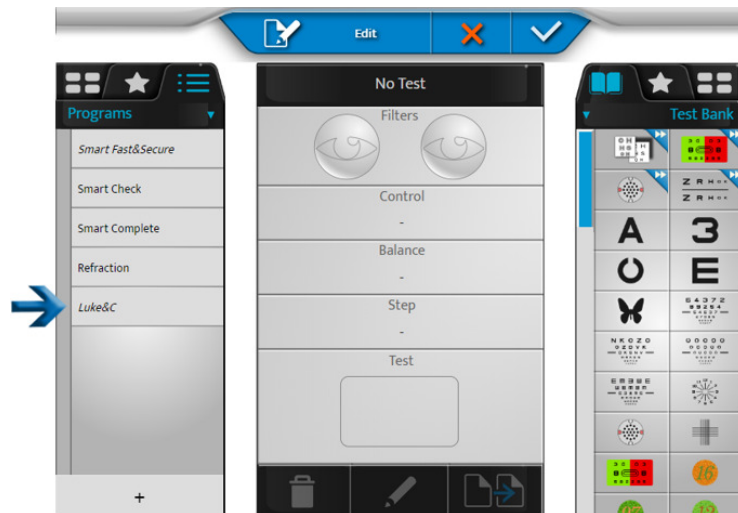

- 4 Click and hold on the name of the program to change its name or order in the list of program .



- 5 Click on  to edit the program.
 > The list of tests appears in the right column.
- 6 Select a first test from the test bank, favorites or the library (by clicking on the corresponding tab at the top of the right column).

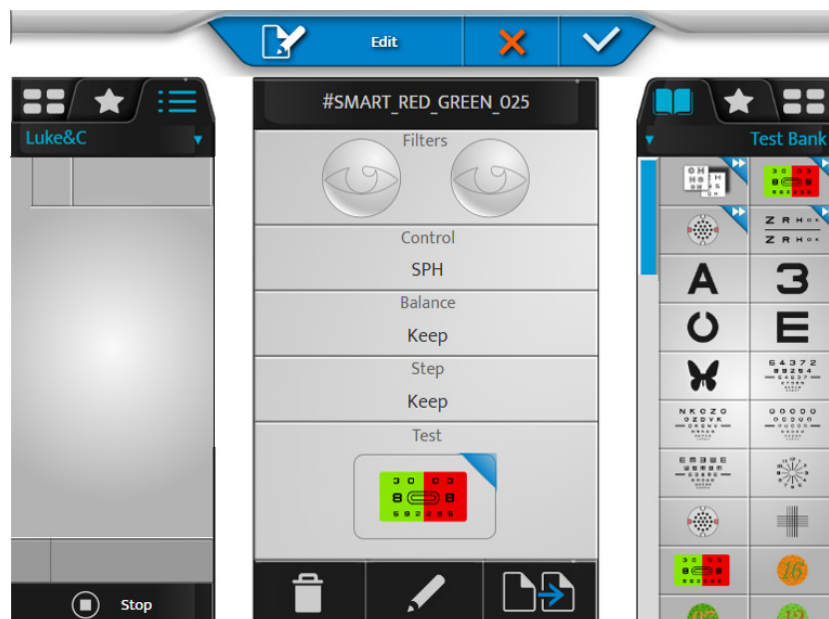



- o The test contents appear in the center block of the screen.
- o The contents of the program appear in the left section.

- 7 Click on the test and drag it and drop it in the program's test list (left column) in the intended location.



- 8 Do the same for the following tests to compose your program.

- 9 You can then click on:

-  > to remove the selected test
-  > to edit and change the test
-  > to duplicate the program



> It is possible to change the order of the tests by dragging and dropping the list of tests in the program.

- 10 Click on  to validate the changes.



You can click on [Stop] to return to the list of programs, edit tests or favorites before you exit edit mode by validating with the key .

Customize test

The Vision-R™700 allows you to edit the specific test in great detail.



1 Press on  > .

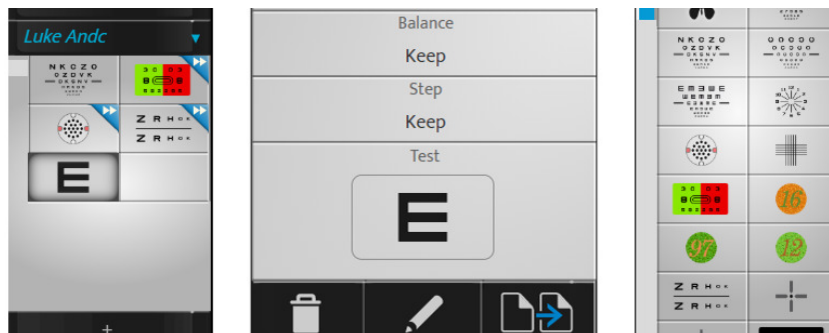

2 Select the test to customize (on the left column).



3 You can then click on:

-  > to remove the selected test
-  > to edit and change the test
-  > to duplicate the test

> The following page appears:

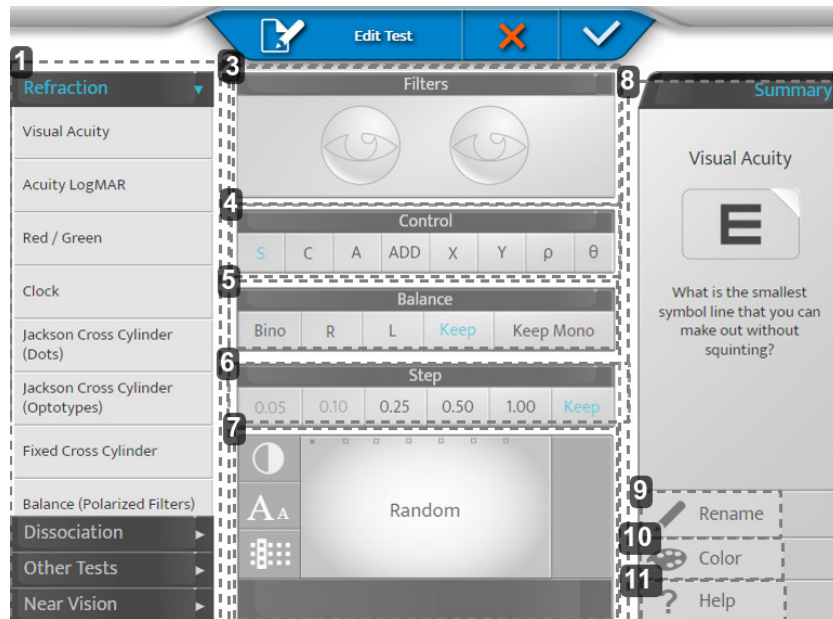

1. Zone 1

Set the test category and apply the default settings for that category.

2. Zone 2

Allows you to adjust the different settings of the test.

3. [Filters]

Allows you to view and select the filters placed in front of the patient's eyes (Red & Green, Maddox, Prisms, Stenopeic Holes, etc.) press long on the eyes.

4. [Control]

Allows you to choose the controlled optical parameter (Sphere, Cylinder, Axis, Addition, Prism components).

5. [Balance]

Allows you to choose the condition of the test (Bino, Right, Left, keep the previous condition, retain or impose the single-eye condition).

> [Keep Mono]: If the previous test is in binocular condition then the condition of the test is forced into monocular.

This setting is particularly recommended for astigmatism testing.

6. [Step]

Allows you to choose the power variation step (0.05, 0.10, 0.25, 0.50, 1.00 or kept the same as before).

7. Display

Allows you to view and change the display of the target presented during the test.

> For acuity boards: allows you to choose either random board selection (depending on the condition) or a particular board. And to define how it is presented (rows, columns, letters), its acuity level and the contrast or background.

8. Zone 3

Allows you to customize the test icon and test help.

9. [Rename]

Allows you to rename the test

10. [Color]

Allows you to change the color of the corner (top right) of the icon

11. [Help]

Allows you to change the text of the test help.

Don't forget to save by clicking on ✓.

Example

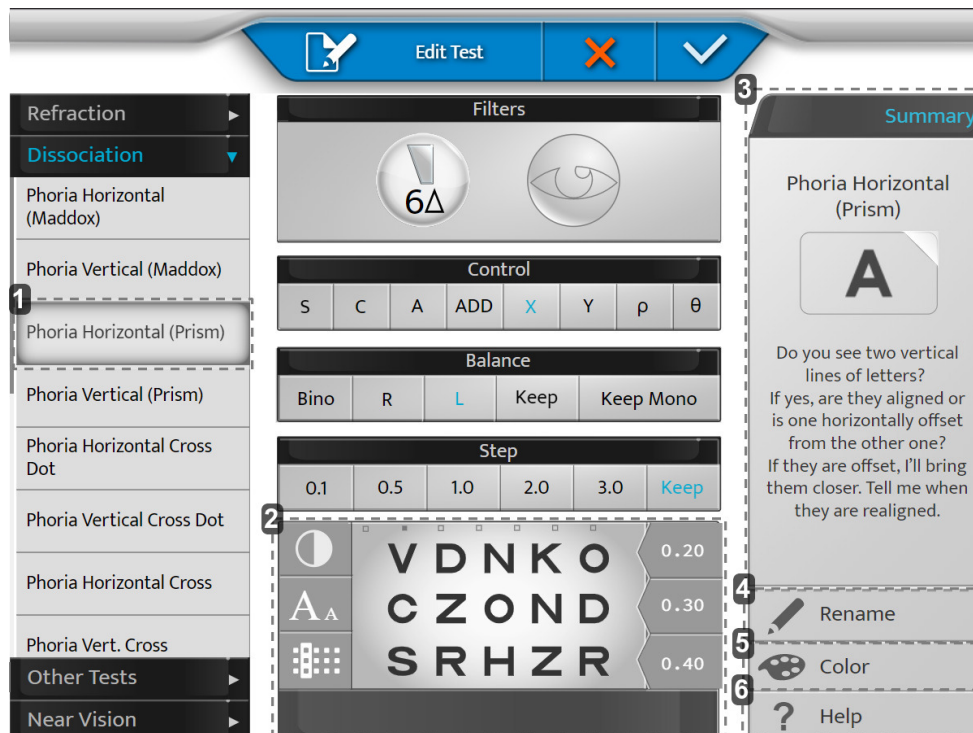

1. [Phoria Horizontal (Prism)]

By selecting a panel on the left it will assist with default settings (auxiliary lens change, prism activation, etc.) It is possible to override the suggested settings.

2. [Display]

Personalize your chart.

3. [Summary]

Help wording with each default test.

4. [Rename]

Name your test as you wish.

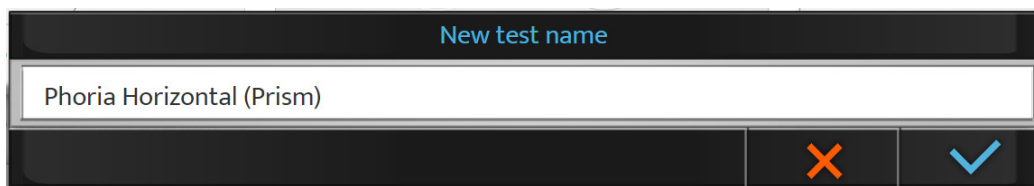

5. [Color]

Choose your color for recognition.

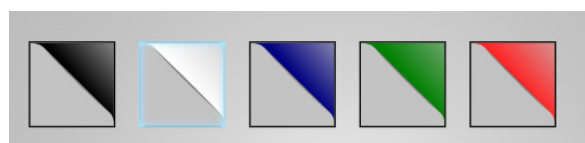

6. [Help]

Write your own speech to use during test (help button).

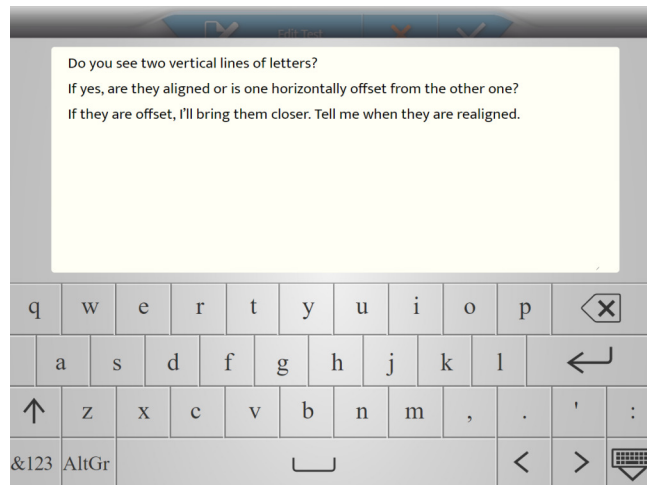

b. Favorite tests selection

The Vision-R™700 allows you to add favorite test.

- 1 Click on the [Favorites] tab in the left column.

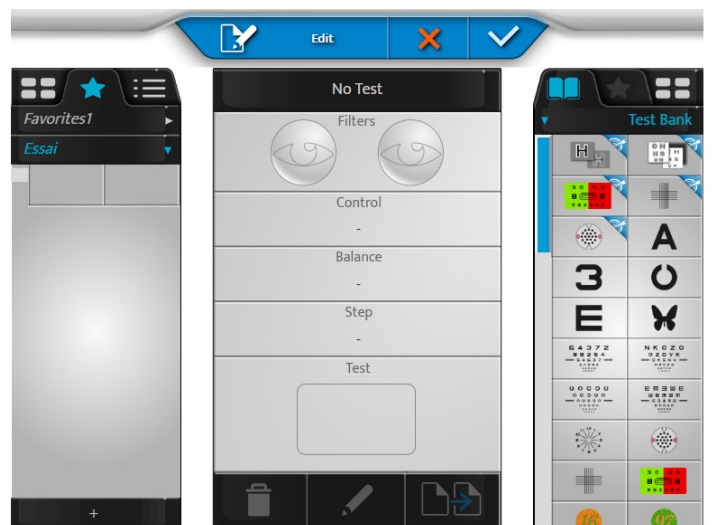

- 2 Select a first test from the test bank or library (by clicking on the corresponding tab at the top of the right column).

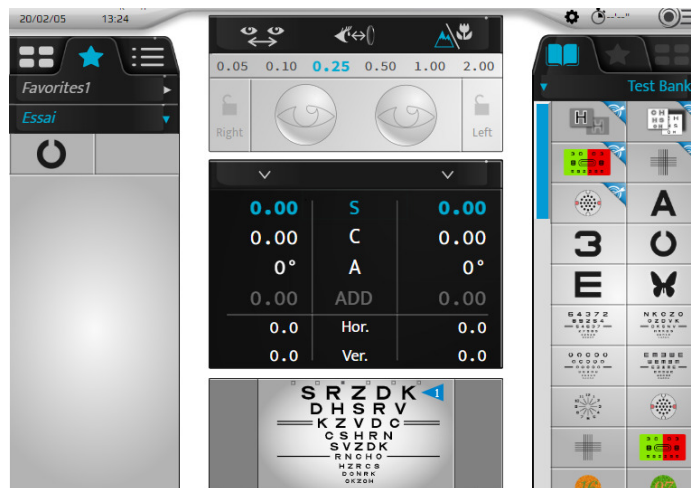

- 3 Click on the test, drag it and drop it in the favorite test section (left column) at the intended location.



- 4 Do the same for the following tests.



- 5 You can then click on:

-  > to remove the selected test
-  > to edit and change the test
-  > to duplicate the favorite





> You can change the order of the tests by dragging and dropping in the test section.

- 6 Click on [+] to create a new favorite test section.



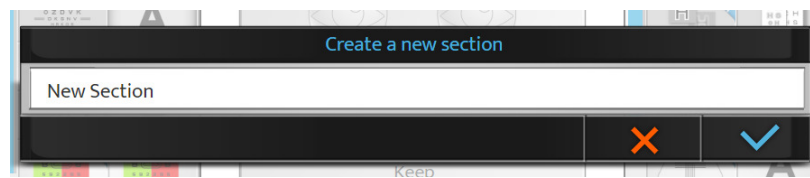

- > The following page appears:

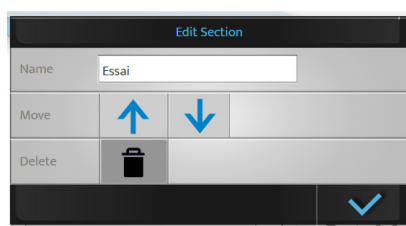

- 7 Click on:
- o  to confirm
 - o  to cancel

- 8 Click and hold on the name of the favorite to change its name or order in the list of favorites.



You can remove the created program by pressing .

9 Finally, click on:



- o  to confirm
- o  to cancel

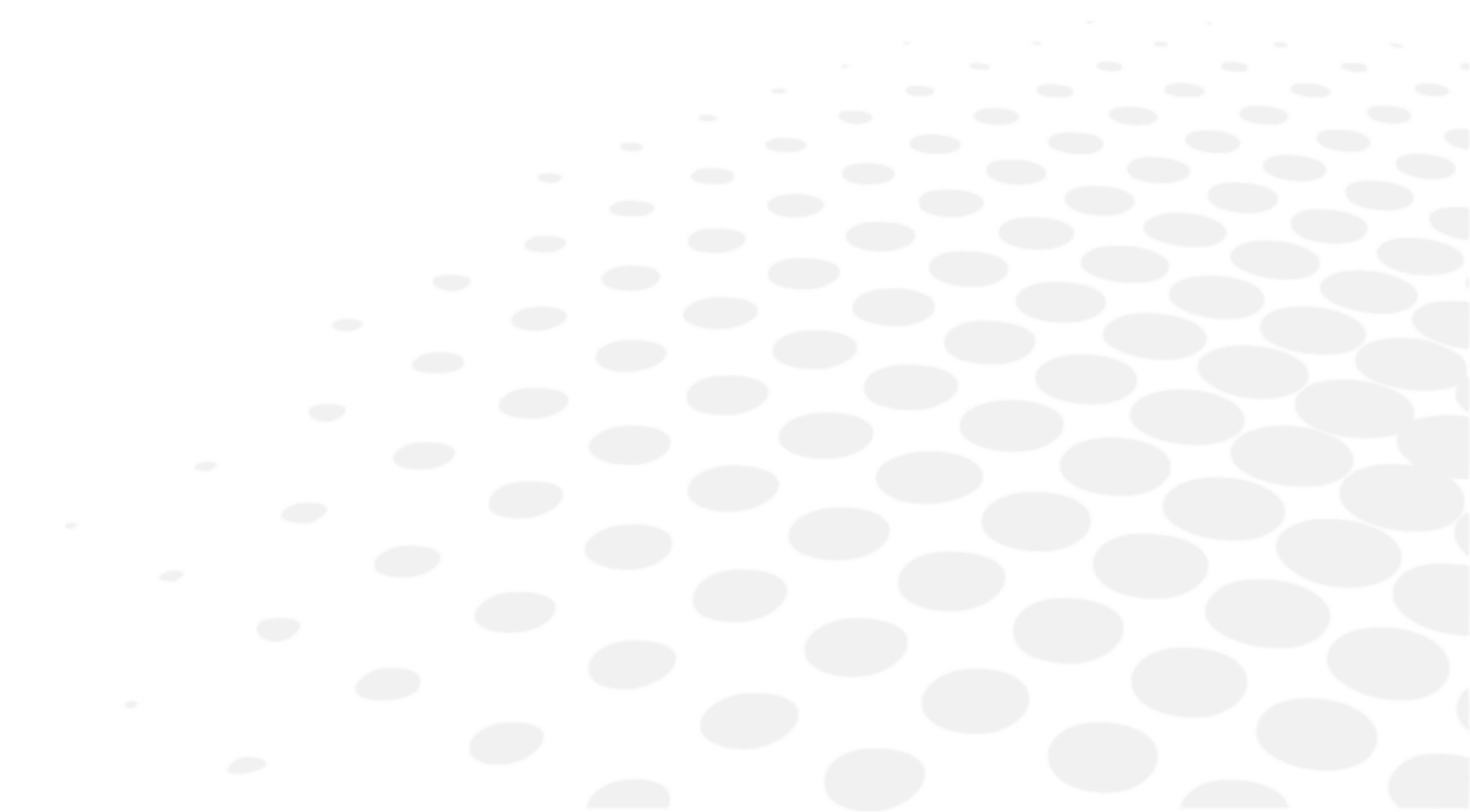

A favorite test section can be removed if more than one section is present. If only one section is present, it cannot be removed.

X. INSTRUMENT SETTINGS



It is possible to modify the default settings of the instrument by pressing on  > .

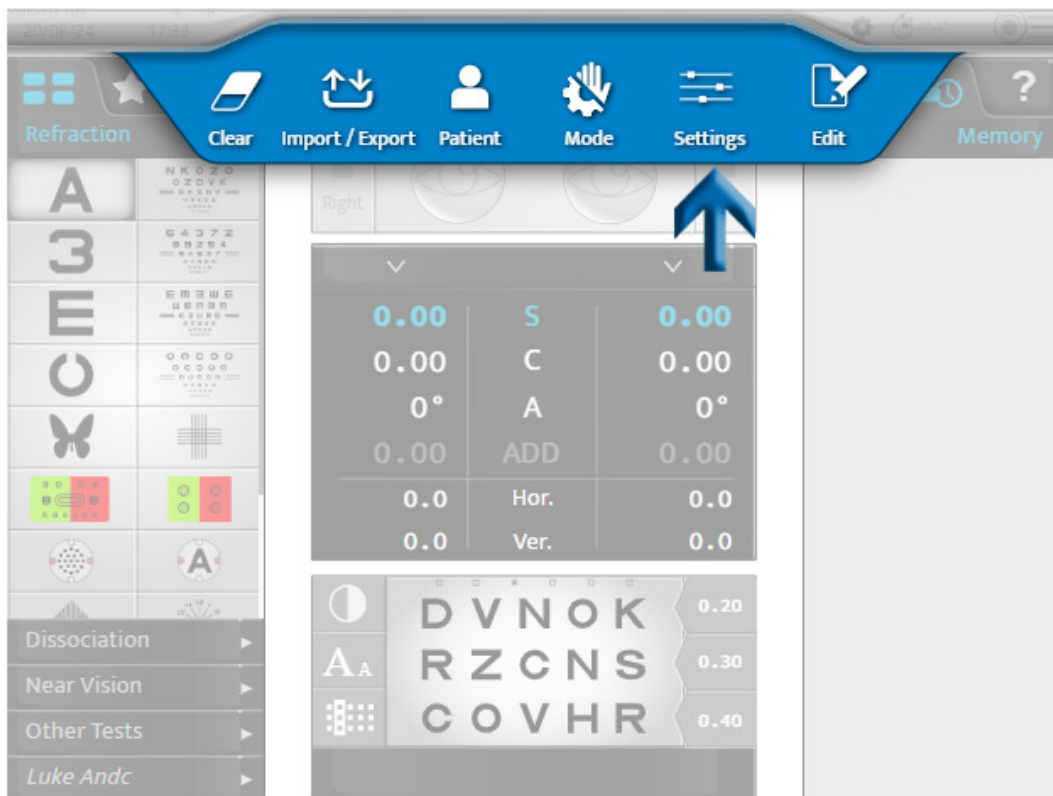

> The instrument settings page is displayed.

1. General information

The general information menu has two pages:

1. [General]
2. [Devices]

1 - Page [General]

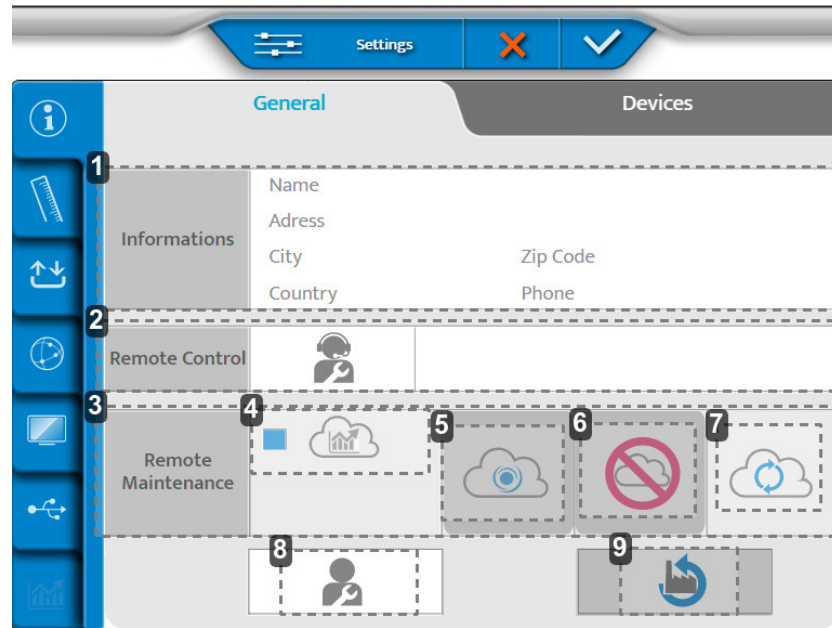

1. *[Informations]*
Customer's information
2. *[Remote Control]*
Remote access,
3. *[Remote Maintenance]*
Access to the remote maintenance
4. *Access to the statistics and the log files*
5. *Recording on SIS*
6. *Deletion of recording*
7. *Connection refreshing*
8. *After-sales service*
9. *Restoration of the factory default settings*

2 - Page [Devices]

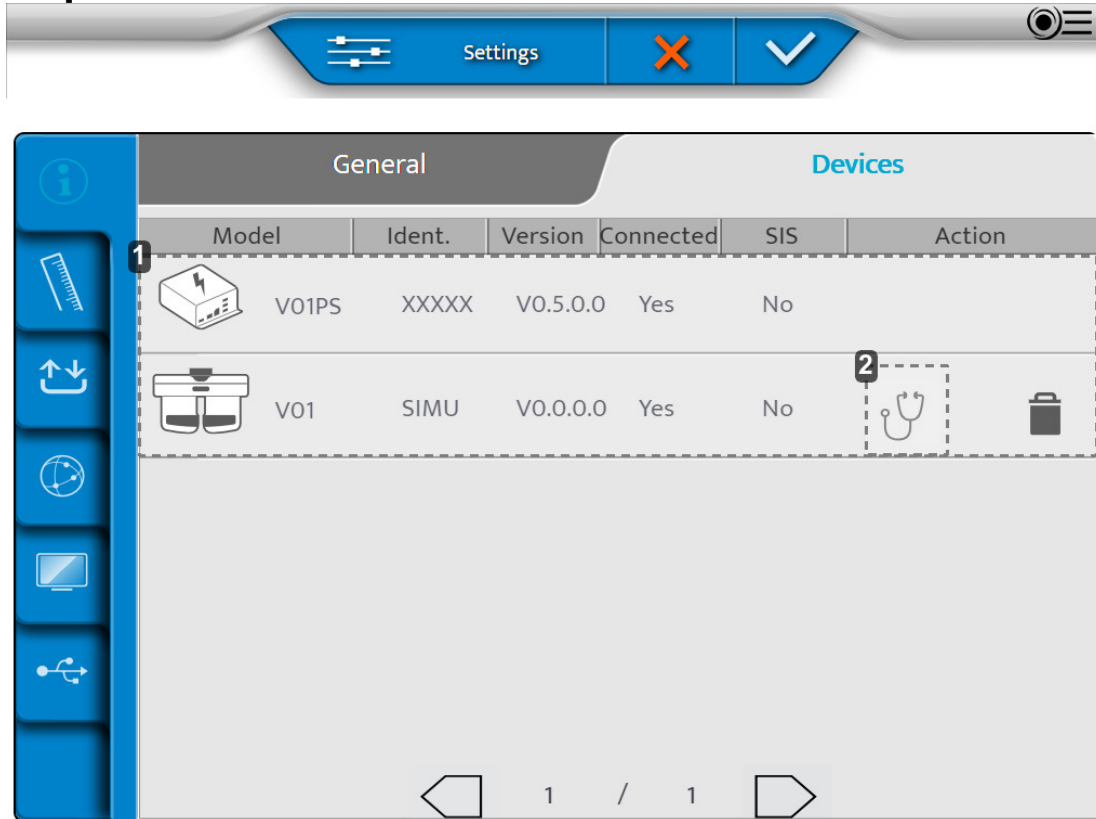

1. Information concerning the various components of the instrument
2. Carry out autotests

Once the adjustments are made, press on:

- to confirm.
- to cancel.

Carrying out the autotests of the photopter head

- 1 On the [Device] page, press on .
 - > The following page appears:

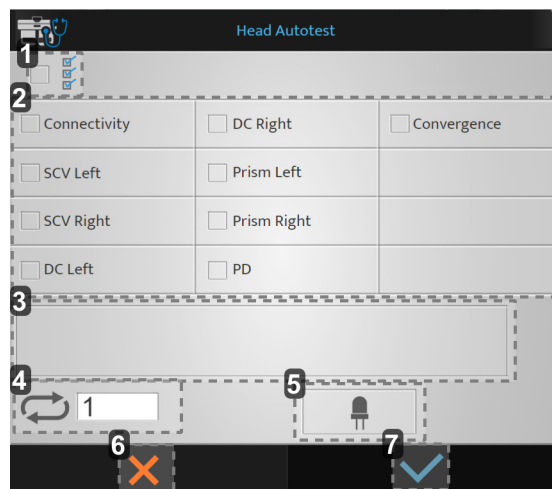

1. Launch of all the autotests
2. List of available autotests

3. Display of errors codes and comments
4. Number of autotests launch
5. Test of LEDs (horizontality / near-vision light)
6. Launch cancellation
7. Launch confirmation

2 Choose the autotests which you wish to perform and press on .

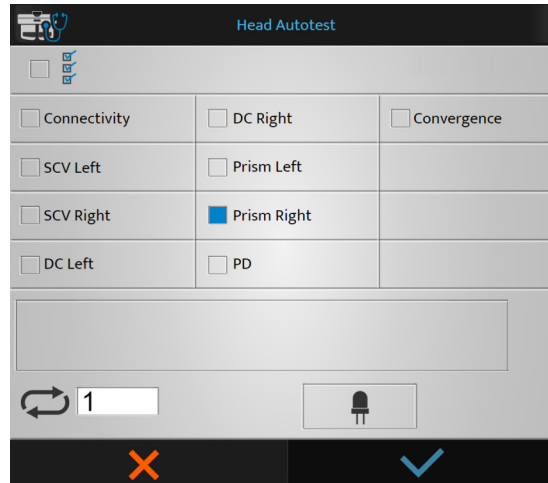

> The autotests starts.

Carrying out the autotests of the console

1 On the [Device] page, press on .

> The following page appears:

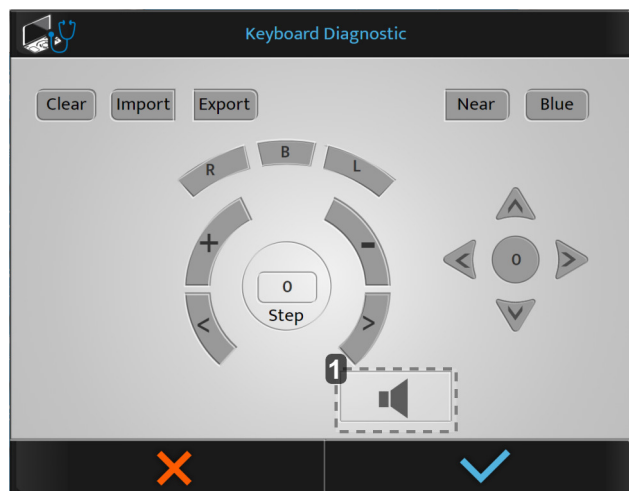

1. Test of the speaker



If you press a button on the console, then the buttons are displayed in blue.

2 Choose the autotests which you wish to perform and press on .

> The autotests starts.

2. Measurement data

The measurement data menu has three pages:

1. [Dated Format/Units]
2. [Distance]
3. [Lens Step]

1 - Page [Data Format / Units]

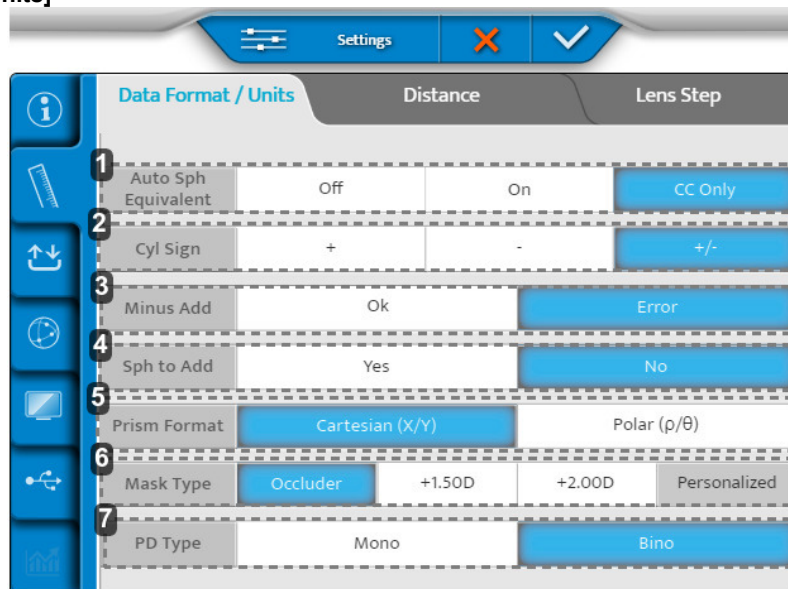

1. [Auto Sph Equivalent]

Automatic maintenance of the equivalent sphere during a refraction process.

2. [C Sign]

Define the sign of the cylindrical power (C).

3. [Minus ADD]

Allows for the addition of a negative value.

- o OK: authorizes the negative addition for specific tests
- o Error: only a positive addition can be taken into account

4. [Sph to Add]

Allows user to combine or separate the addition of the near vision from/to the far-vision sphere.

5. [Prism format]

6. [Mask type]

The choice of the type of mask during a test in monocular vision.

7. [PD type]

Define the default settings of monocular or binocular pupillary distance.

2 - Page [Distance]

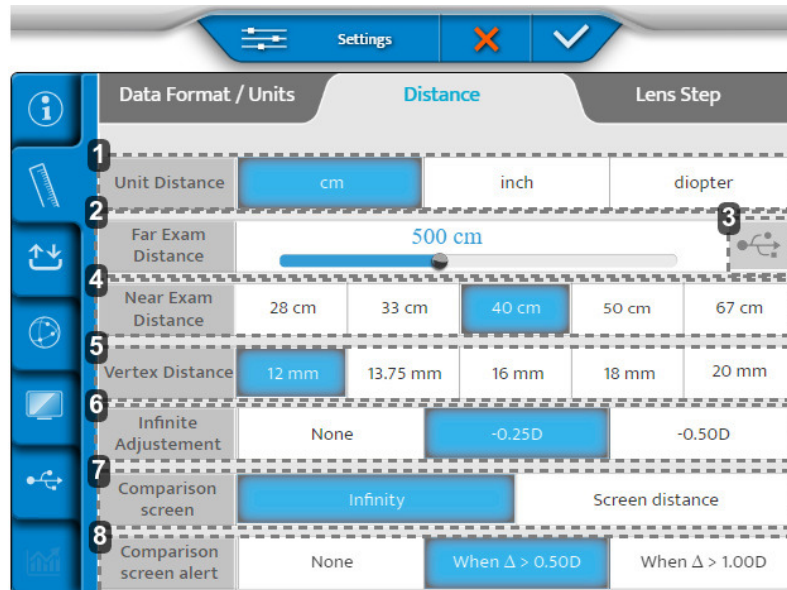

1. [Unit distance]

Define the default distance unit:

- in cm
- in inches
- in diopters

2. [Far exam distance]

Define the test presentation screen distance.

To modify this distance move the cursor to the left or the right (steps from 25 cm from 3m to 8m).

3. Generation of personalized optotypes

4. [Near exam distance]

Defines the distance of the near-vision test.

> The values indicated correspond to a default setting in cm.

5. [Vertex Distance] (in mm)

Sets the Vertex distance by default taken into account for the conversion of the refraction value of a standard reference distance.

6. [Infinite Adjustments]

Conversion to "infinite". None or a fix value.

7. [Comparison Screen]

Default setting on comparison screen.

8. [Comparison Screen Alert]

Alert ECP if the difference is higher than selected value. (Value to appear in red in Bluetouch).

3 - Page [Lens step]

	Data Format / Units	Distance		Lens Step			
1	Sphere Step	0.05 D	0.10 D	0.25 D	0.50 D	1.00 D	2.00 D
2	Cylinder Step	0.05 D	0.10 D	0.25 D	0.50 D	1.00 D	2.00 D
3	Axis Step	1 °	5 °	10 °	20 °	45 °	90 °
4	Prism Step	0.1 Δ	0.5 Δ	1.0 Δ	2.0 Δ	3.0 Δ	6.0 Δ
5	PD Step	0.5 mm		1 mm			
6	Cross Cylinder power	+/- 0.25 D		+/- 0.50 D			
7	Axis rounding	No	Closest 5° (Always)	Closest 5° (Cyl<1,50D)			

1. [Spherical Step]

Define the default variation step of the sphere.

2. [Cylinder Step]

Define the default variation step of the cylinder.

3. [Axis Step]

Define the default variation step of the axis.

4. [Prism Step]

Define the default variation step of the prism.

5. [PD Step]

Define the default variation step of the pupillary distance.

6. [Cross Cylinder Lens]

Sets the default value of the cross cylinder, used for finding the cylinder in manual mode.

7. [Axis Rounding]

Determining whether rounding of the axis should be performed automatically.

Once the adjustments are made, press on:

-  to confirm.
-  to cancel.

3. Import/Export data

The Import/export menu has three pages:

1. Import/export
2. Memory
3. Default export

1 - Page [Import / Export]

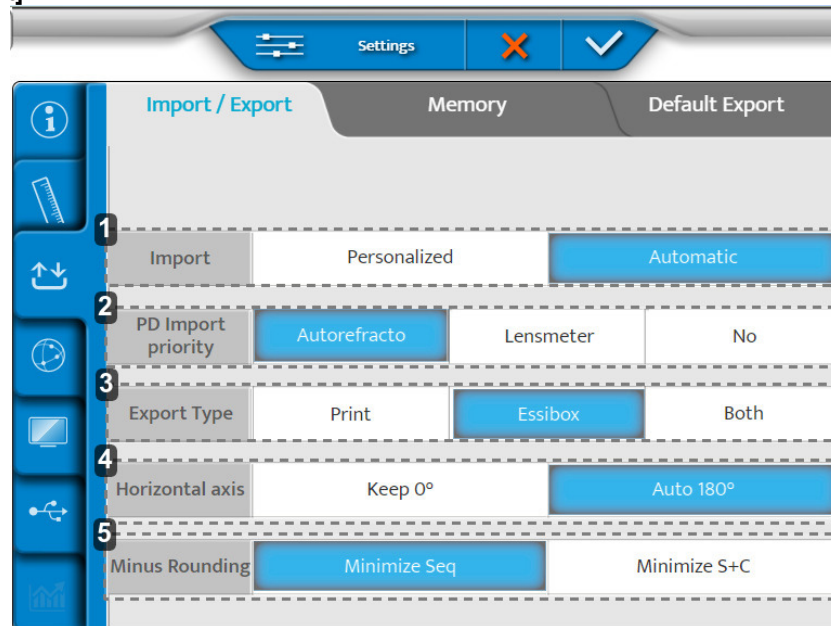

1. [Import]

Describe the type of importing:

- o Manual
- o Automatic

2. [PD Import Priority]

Determining which import from which instrument gets priority to be inserted in phoropter.

3. [Export Type]

Defines the way data is processed during export:

- o Sent to the printer
- o Sent to the Essibox
- o Both

4. [Horizontal axis]

Selecting default value of either 0 or 180°.

5. [Minus Rounding]

Selecting the minus rounding.

2 - Page [Memory]

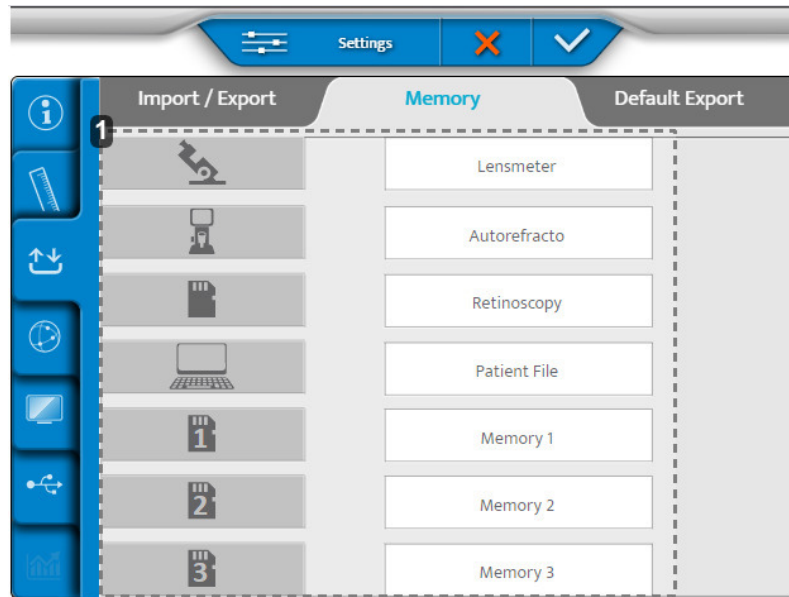

1. List of available memories

3 - Page [Default Export]

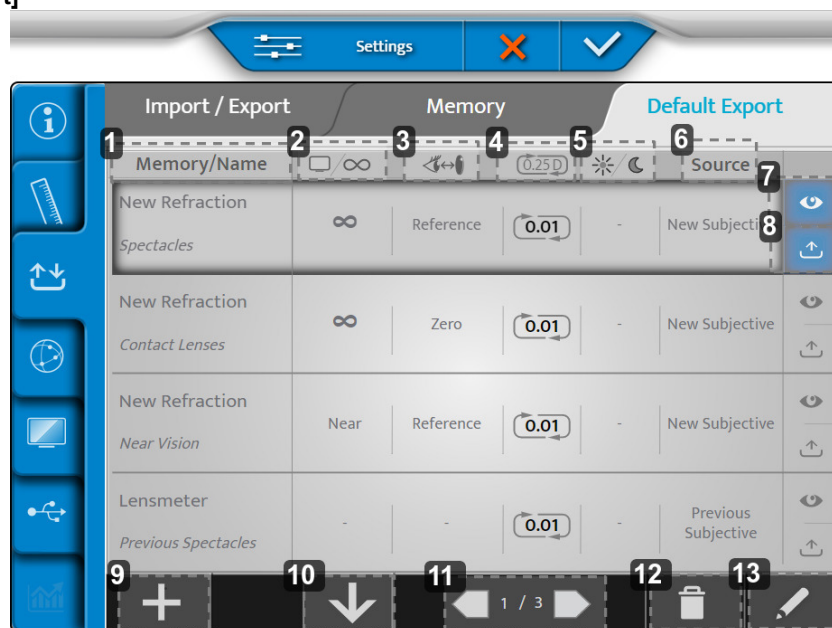

1. [Memory/Name]
Indicates the memory to be exported and the name of the corresponding data type.
2. Screen distance
Indicates the distance for which the correction is exported.
3. Vertex distance
Indicates the vertex distance for which the correction is exported.
4. Rounding
Indicates the correction step and its possible rounding type.
5. Day/night vision
Indicates the conditions under which the test is performed, day or night.
6. [Source]
Label the data type according to the source.

7. Display

View the default exported data display.

8. Export

Export the data by default.

9. More

Add a new data type to the export configuration.

10. Organize

Organize the order of the data types to be exported.

11. Pagination

Navigate through the different pages of the export configuration.

12. Waste bin

Remove an export data type.



13. Pen

Edit and change an export data type.



It is possible to rename the memories (long press on name).

Once the adjustments are made, press on:

-  to confirm.
-  to cancel.

4. Communication settings

The element settings menu consists of three pages:

- Chart
- IP
- Essibox.com

1 - Page [Chart]

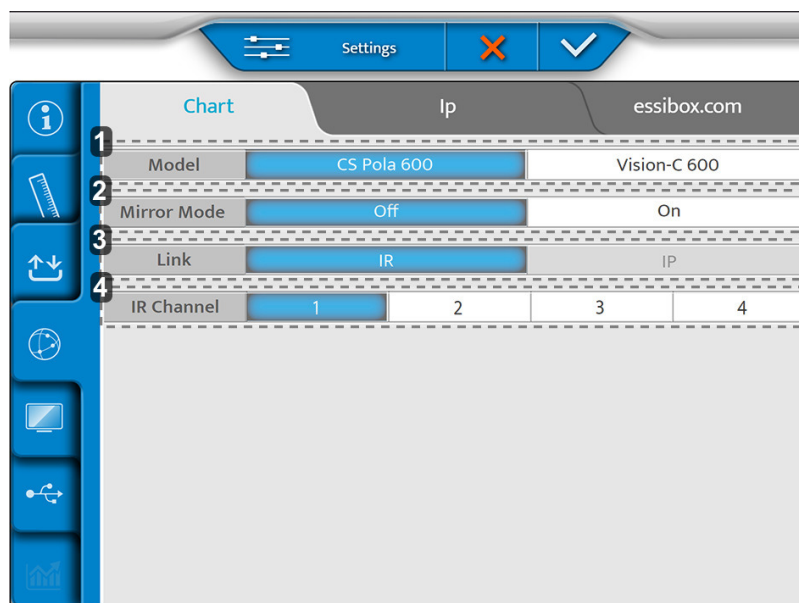

1. [Model]

xxx

2. [Mirror Mode]

Mirror Mode Activation (according to configuration)

3. [Link]

4. [IR Channel]

Used during set up of chart system for communication

2 - Page [Ip]

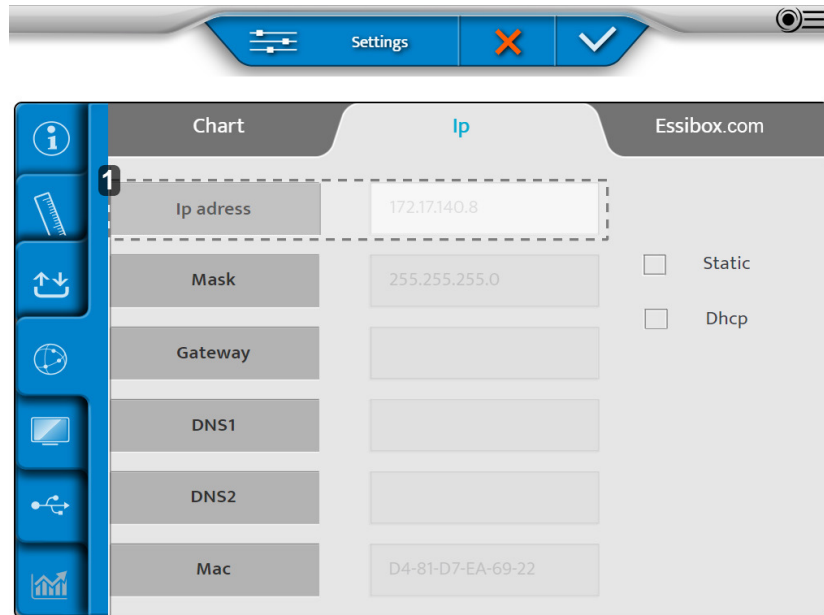

1. [Ip address]

Can be [Static] or [Dhcp]

3 - Page [Essibox.com]

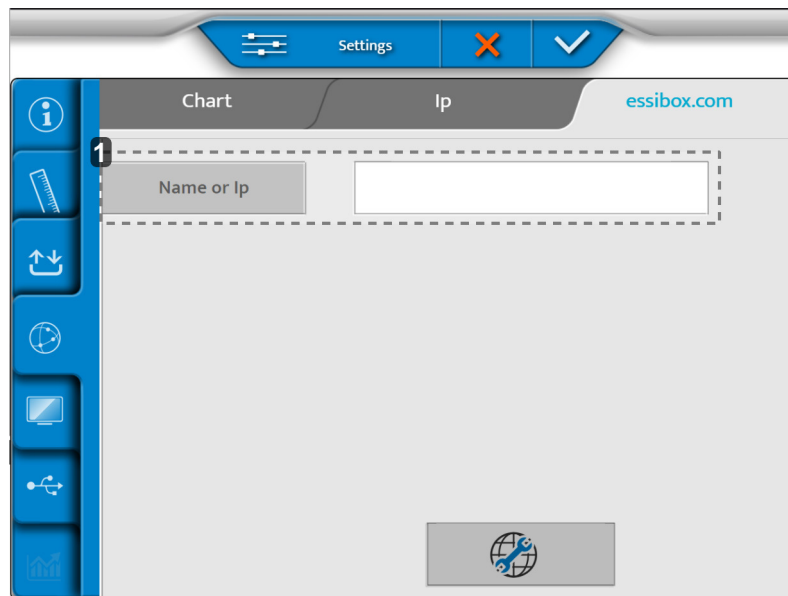

1. [Name or Ip]

Name or Ip of the Cbox that must be set up.

Once the adjustments are made, press on:

-  to confirm.
-  to cancel.

5. Local settings

The local settings menu consists of three pages:

- Chart Display
- Keyboard Settings
- Regional Settings

1 - Page [Chart Display]

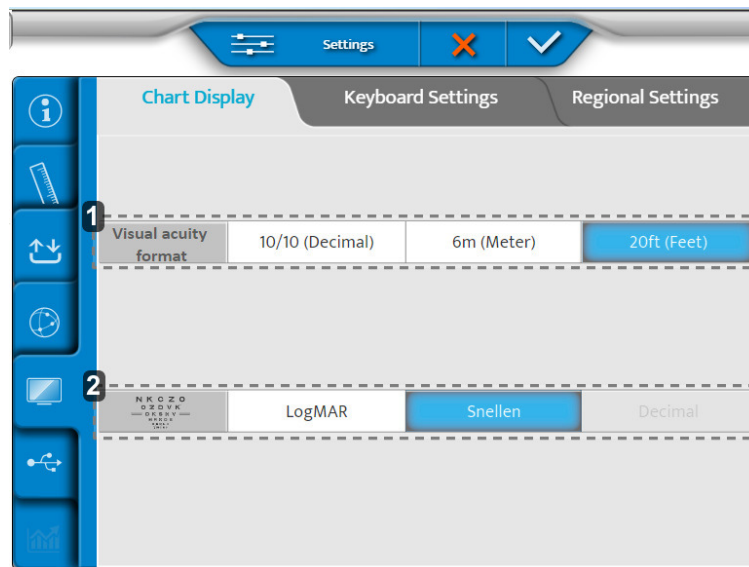

1. [Visual acuity format]

Define the visual acuity format depending on local usage.

2. ETDRS progression

Configuration of the ETDRS progression : logMar or Snellen.

2 - Page [Keyboard Settings]

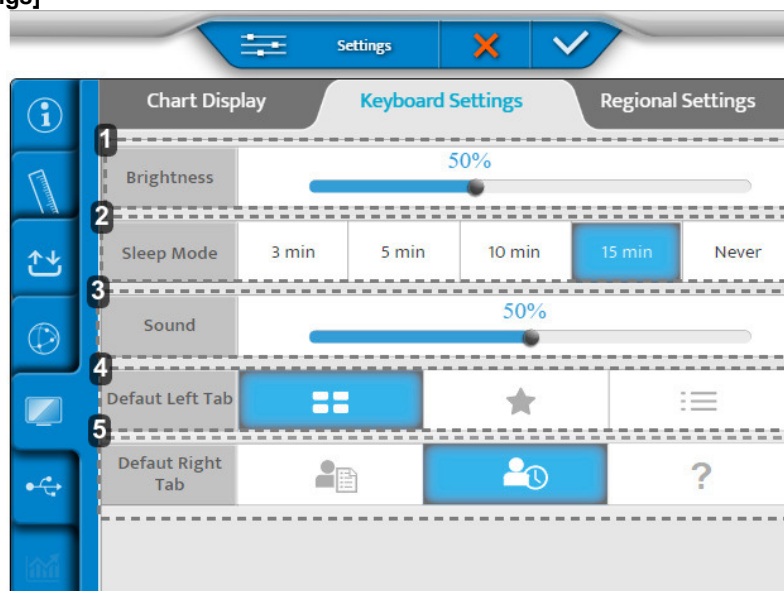

1. [Brightness]

Sets the console screen brightness level

2. [Sleep Mode]

Sets console sleep time

3. *[Sound]*

Sets the sound level of the console screen

4. *[Default Left Tab]*

Sets the default display on the left side of the console screen

5. *[Default Right Tab]*

Sets the default display on the right side of the console screen

3 - Page **[Regional Settings]**

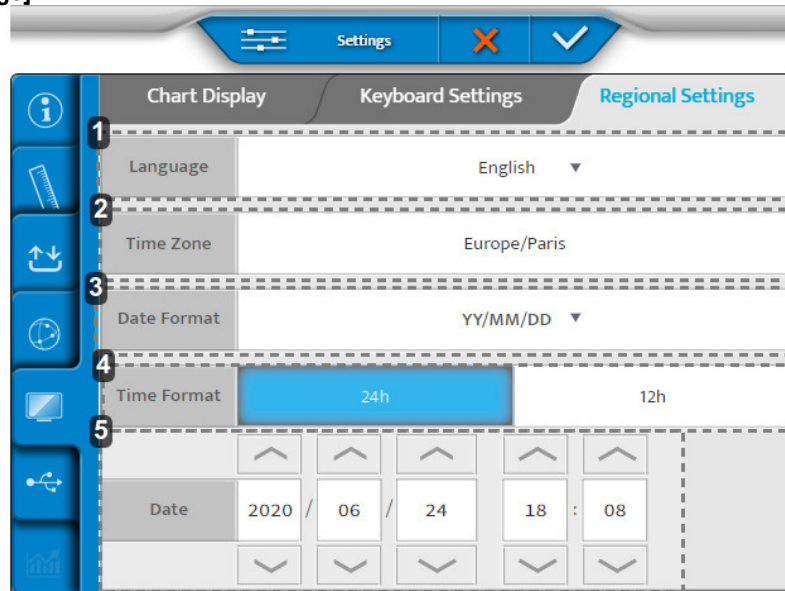

1. *[Language]*

Sets the display of the console language

2. *[Time Zone]*

Sets the display of the console time zone

3. *[Date Format]*

Sets the display of the console date format:

- o Year/Month/Date > [YY/MM/DD]
- o Month/Date/Year > [MM/DD/YY]
- o Date/Month/Year > [DD/MM/YY]

4. *[Time Format]*

Sets the display of the console time format

5. *[Date]*

Sets the display of the console date format

Once the adjustments are made, press on:

- ✓ to confirm.
- ✗ to cancel.

6. Backups restore

The backups restore menu has two pages:

1. Backup
2. Restore

1 - Page [Backup]

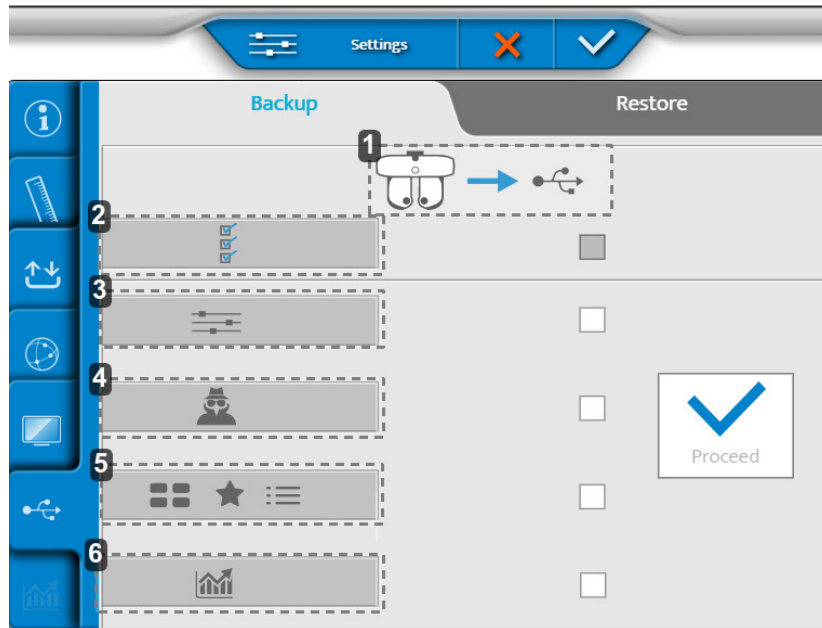

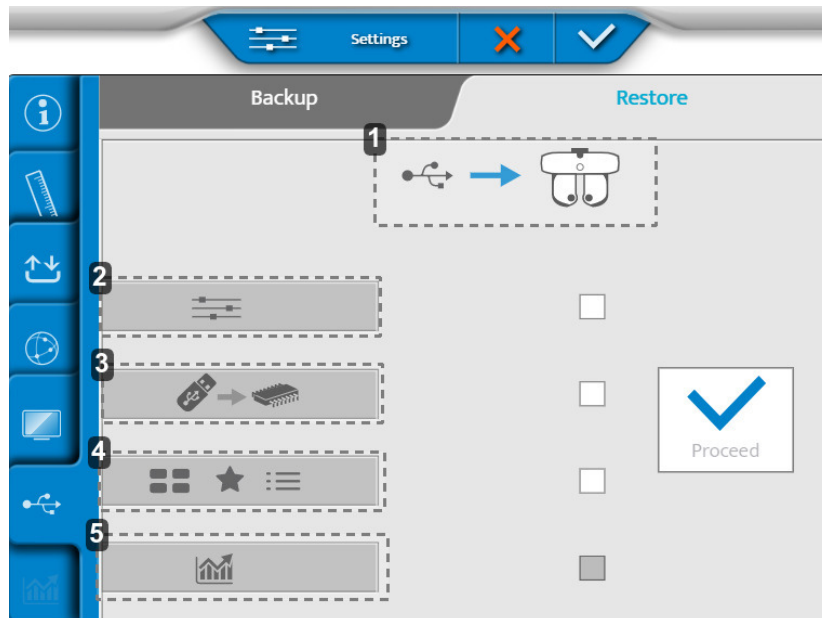

1. Export of refraction head data to an USB key
2. Export of all the instrument data
3. Settings export
4. Export of the technician data
5. Export of tests, favorites and test programs
6. Statistics exportation

2 - Page [Restore]



1. Importing of data from an USB key to the refraction head
2. Settings importing
3. Importing a memory update
4. Importing new tests, favorites and test programs
5. Statistics importing

Once the adjustments are made, press on:

-  to confirm.
-  to cancel.

XI. ERROR DISPLAY

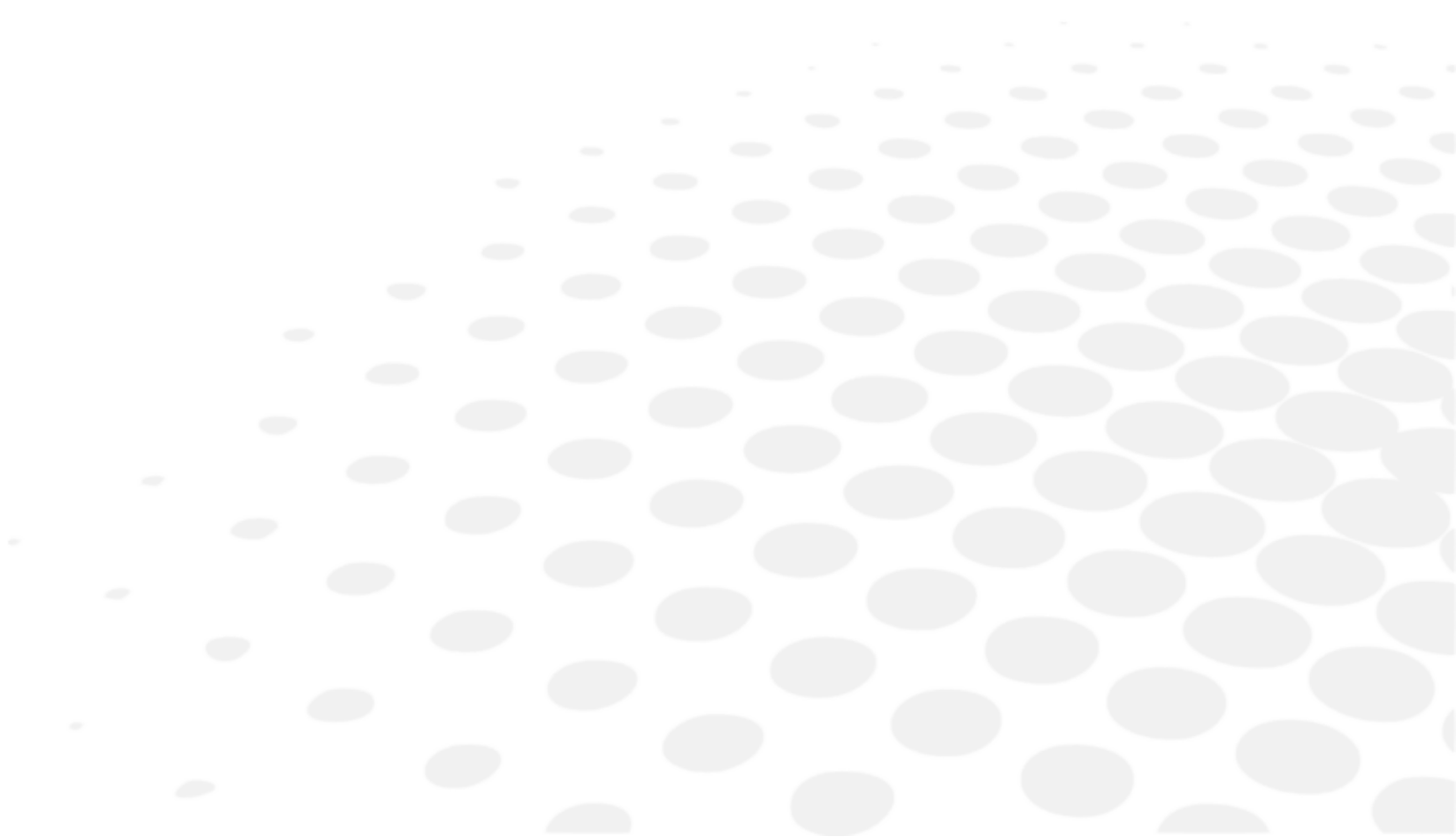

This section is not applicable.

XII. SAFETY CONSIDERATION

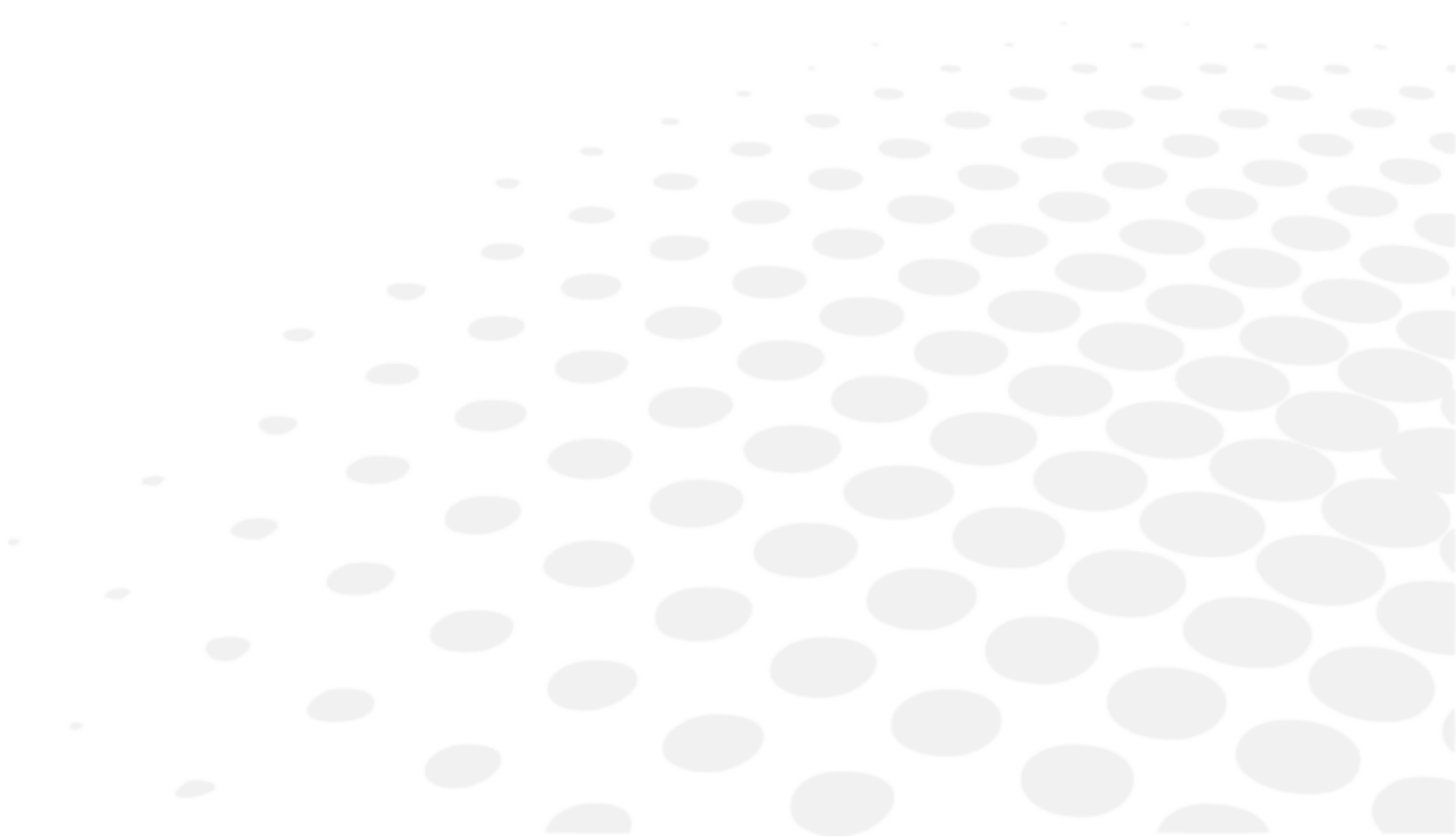





Any serious incident that has occurred in relation to the device should be reported to the manufacturer and the competent authority of the Member State in which the user and/or patient is established.

Vision-R 700 is a class I medical device.













Basic UDI of the device: 361502VISIONRCG









1. Symbols (document, device & packaging)

a. On the document

SYMBOL	DESCRIPTION
	Caution: a hazardous situation that, if not avoided, could result in minor or moderate injury.
	Warning: a hazardous situation that, if not avoided, could result in death or serious injury.
	Danger: a hazardous situation that, if not avoided, will result in death or serious injury.
	Important and/or useful additional information to learn relating to the text in this manual.
	Tips: practical advice.

b. On the device and packaging

SYMBOL	DESCRIPTION
	Alternate current
	D.C. current
	Applied, type B parts.
	Manufacturer
	Manufacturing date (year)
	Stand by mode
	CE Marking (European regulation relating to medical devices).
	Medical device
	Consult instructions for use or consult electronic instructions for use.
	Compliant to FCC standards
	Waste disposal symbol in accordance with Directives 2012/19/EU and 2011/65/EU
	ON = Turned-on (power supply connected to the mains)
	OFF = Turned-off (power supply disconnected to the mains)

	Handle with care
	This way up
	Maximum stacking of 4 products above market product
	Fragile
	Keep dry
	Indicate the thermal limits to which the medical device can be exposed in complete safety.
	Indicate the humidity limits to which the medical device can be exposed in complete safety.
	Indicate the limits of atmospheric pressure to which the medical device can be exposed in complete safety.

2. Precautions for use



- Essential performances: From regulatory stand point, the product has no essential performance.
- Always handle the refraction head by the upper part, do not hold it or never move it by its moving parts (lower).
- Do not install the instrument next to wireless devices (TV, radio, etc.). The instrument may cause interference.
- Never attempt to dismantle the instrument. This may cause a malfunction or fire.
- If the instrument does not work properly, do not touch the inside. Disconnect the plug from the outlet and consult your dealer.
- To avoid pinching injuries when moving the monitor, please do not put your hand between the monitor and the main unit of the console.
- If liquid spills onto the instrument or foreign objects get inside, unplug the plug from the outlet and consult your dealer.
- If any abnormalities occur (noise, smoke, etc.), unplug the plug from the outlet and consult your dealer. Continued use may result in fire or personal injury.
- The continuous time of usage with one patient should not exceed 70 minutes.
- The results and/or technical data resulting from the handling or use of instruments must be analyzed by professionals experienced in various fields of application of the instrument in order to avoid any risk of misreading or incorrect analysis of the data.
- Diagnostics are carried out under the responsibility of the user and Essilor declines any responsibility for the results of these diagnostics.
- The user must use another product before completing the final prescription.
- Do not touch the output connectors (USB, LAN) of the power supply box and the patient simultaneously.
- The presence of fingerprints or dust on the optical parts, for example on the observation windows, affects the accuracy of measurements. It is therefore recommended not to handle them with your fingers and to keep them away from dust. If there are fingerprints or dust on the optical parts, gently wipe them with a soft cloth.
- The covers are fragile, handling them while wearing jewellery or having long nails can lead to scratches.
- The white covers may yellow over time when exposed to ultraviolet light for an extended period.
- When the instrument is not in use, protect it using the cover provided.
- The light emitted from this instrument is potentially hazardous. The longer the duration of exposure, the greater the risk of ocular damage. Patient exposure to light from this instrument when operated at maximum intensity will exceed the safety guideline after 70 minutes.
- There is no limit conditions that the device can tolerate.



- Do not try to repair or modify the instrument.
- Never try to perform any repairs inside the instrument yourself. In the event of malfunctions, consult your dealer.
- To avoid any risk of electrocution, do not open the cover. Consult your dealer for all repairs.

3. Contraindication

No contraindications.

4. Side effects

No undesirable side effects.

5. Exclusion of liability clause



- The results and/or technical data resulting from the handling or use of instruments must be analyzed by professionals experienced in various fields of application of the instrument in order to avoid any risk of misreading or incorrect analysis of the data.
- Diagnostics are carried out under the responsibility of the user and Essilor declines any responsibility for the results of these diagnostics.
- Each instrument constructed, marketed and/or put on the market directly and/or indirectly by Essilor is designed according to the provisions and the regulations in force. It contains the necessary information to ensure the intended use and permitting the identification of the manufacturer, taking into account the training, experience and knowledge of the intended user.
- This information, including that contained in the accompanying product manuals and the technical advice provided, whether oral, written or communicated during a demonstration, is provided on the basis of best knowledge. However, it must be considered as information without any binding effect, including third-party industrial property rights. It does not exempt the customer from checking current versions, communicated advice and suggestions, particularly the technical safety data sheets, instructions and technical information, as well as assessing the capacity of the instruments to ensure the intended use during delivery.
- The application, use and handling of these instruments as well as the products developed by the customer on the basis of technical consulting and/or maintenance activities are not under the control of Essilor. They are therefore the sole responsibility of the customer. Essilor declines any responsibility in the matter, as indicated below.
- The sale of products is governed by the general conditions of sale and delivery as modified.

Confidentiality of patient data

The instrument is a system that can save, store and share relative information with the patient such as refraction measurements, name or photo. It is the device user's responsibility to comply with patient data confidentiality regulations, applicable on their site.

Please note that this device is intended only for professional medical use. Personal Patients data are not displayed on the screen.

6. Power source



- **WARNING:** To avoid the risk of electric shock this device must only be connected to a supply mains with protective earth.
- Take care to use the power cord grounding cable when connecting to the ground terminal.
- Do not damage the power cord (by bending it, pulling it or placing heavy objects on top of it, etc.). Do not modify it either. If the cord is damaged (loose contact, damaged sheath, etc.), replace it with a new cord. Continued use may result in an electric shock or fire.
- Do not touch the power plug with wet hands. This may cause an electric shock.
- If you do not use the instrument for an extended period, disconnect the power cord from the outlet.



- Do not use multi-socket power strips, adapters or extension cords to connect the instrument to the mains.
- Make sure the power cord is fully inserted into both the plug and the instrument. Failure to insert it properly may result in a fire or electric shock.
- Clean the power cord regularly to avoid dust buildup. If the cord is dirty, it may cause a malfunction or fire.
- If the power cord becomes hot after using the instrument, check that it is not dirty. If it is not, replace the power cord with a new one. Continued use may cause malfunction or personal injury.
- Use the instrument with the appropriate supply voltage. Continued use with a supply voltage greater than the rated power may cause malfunction or fire.
- Hold the plug when you insert or remove the power cord.
- Use only the power cord provided with the device, model H05VV-F cord type 3G 10 mm², provided with VIIG plug. SJT 3x18 AWG provided with hospital grade plug Nema 5-15P HF for US/CAN ; 2 m in length.

7. Precautions regarding IT Network



- This instrument can transfer data to a computer or other devices via a USB or RJ45 interface. These devices must comply with the standard IEC 62368-1. Purpose is to refraction data.
 - IT Network must be set up in order to accept the text file from product address (firewall parameters)
 - Transfer routines are compliant with FTP protocols.
 - No hazardous situation was reported through product design risk analysis.
 - External equipment intended for connection to signal outputs on the device shall comply with the relevant product standard for such equipment IEC 62368-1 for IT-equipment. In addition, all such combinations – Medical Electrical Systems – shall comply with the requirements stated in clause 16 of IEC 60601-1. Any equipment not complying with the leakage current requirements in IEC 60601-1 shall be kept outside the patient environment (at least 1.5 m from the patient support or shall be supplied via a Separation transformer to reduce the leakage currents).
- Any person who connects external equipment to the device has formed a Medical Electrical System and is therefore responsible for the system to comply with the requirements in clause 16 of IEC 60601-1. If in doubt, contact qualified medical technician or your local representative.
- A Separation Device (isolation device) is needed to isolate the equipment located outside the patient environment from the equipment located inside the patient environment. In particular such a Separation Device is required when a network connection is made. The requirement for the Separation Device is defined in clause 16.5 of IEC 60601-1.
- Connecting this instrument to a computer network that includes other equipment may result in safety and data protection risks.
- The responsible organization is expected to identify, analyze, evaluate and control these risks.
- Any subsequent changes to the computer network may cause risks and require further analysis.
- These changes include:
 - changing the configuration of the computer network;
 - connection of additional devices to the computer network,
 - disconnection of elements of the computer network,
 - updating the equipment connected to the computer network;
 - upgrading the equipment connected to the computer network.

Please contact your distributor for detailed information on this instrument.

8. Electromagnetic compatibility



All of the information listed below is based on normative requirements to which manufacturers of electro-medical devices are subject, as defined in the IEC60601-1-2 Ed4 standard.

The device complies with the applicable electromagnetic compatibility standards, however, the user must ensure that any electromagnetic interference does not create an additional risk, such as radio frequency transmitters or other electronic devices.

In this chapter you will find information necessary to ensure that your device is installed and put into service in the best conditions in terms of electromagnetic compatibility. The device's different cords must be separated from each other.

Certain types of mobile telecommunications devices such as mobile phones may interfere with the device. Recommended separation distances must therefore be respected.

The device shall not be used in the vicinity of or placed on another device. If this cannot be avoided, it is necessary to check its proper functioning under the conditions of use before using it. The use of accessories other than those specified or sold by the manufacturer as replacement parts may result in an emissions increase or a decrease in the immunity of the device.

In case the device stop working, reset the device, restart test from the beginning, do not use the previous data for make prescription.

a. Length of cables, cords, etc.



The length of cables or cords must be greater than 3 meters.

TYPE OF TEST	IN ACCORDANCE WITH
RF emission	CISPR 11, Class A
Harmonic current emission	IEC 61000-3-2
Voltage fluctuations and flickering	IEC 61000-3-2
Immunity to electrostatic discharge	IEC 61000-4-2
Radiated Immunity - Electromagnetic Fields	IEC 61000-4-3
Immune to electrical fast transients and bursts	IEC 61000-4-4
Shock-wave immunity	IEC 61000-4-5
Conducted radio frequency disturbance immunity	IEC 61000-4-6
Radiated Immunity - Magnetic Fields	IEC 61000-4-8
Immunity to voltage dips, brief cuts and voltage variations	IEC 61000-4-11

b. Recommended separation distance



The device is intended for use in an electromagnetic environment in which RF radiation disturbances are controlled.

The user or installer of the device can help avoid electromagnetic interference by maintaining a minimum distance, depending on the maximum power of the radio frequency transmission equipment. Portable RF communications devices (including devices such as antenna cables and external antennas) must not be used closer than 30 cm (12 inches) to any part of the device, including cables specified by the manufacturer. Otherwise, the performance of these devices could be affected.

c. Electromagnetic emissions



This product is intended for use in the electromagnetic environment specified below. It is up to the customer or the user to verify that the instrument is used in this environment.

EMISSIONS TEST	COMPLIANCE	ELECTROMAGNETIC ENVIRONMENT – GUIDELINES
Electromagnetic radiation disturbance (Radiated Emissions) (CISPR 11)	Group 1	The product uses RF energy for internal functions.
Disruptive voltage at power stations (Conducted emissions) (CISPR 11)	Class B	
Harmonic current emission (IEC61000-3-2)	Class A Complies	The product may be used in all establishments, including domestic sites and those connected directly to the public low-voltage power.
Voltage variations, voltage fluctuations and flicker (IEC61000-3-3)	Complies	

d. Magnetic and electromagnetic immunity



The product is intended for use in the electromagnetic environment specified below. It is up to the customer or the user to verify that the instrument is used in this environment.

IMMUNITY TEST	TEST LEVEL IEC 60601 & COMPLIANCE LEVEL	ELECTROMAGNETIC ENVIRONMENT – GUIDELINES
Electrostatic discharge (ESD) (IEC61000-4-2)	± 8 kV contact ± 15 kV air	Environment of a professional healthcare facility.
Electrical fast transients and bursts (IEC61000-4-4)	± 2 kV for power supply lines ± 1 kV for the signal ports	
Shock Waves (IEC61000-4-5)	± 2 kV in differential mode ± 1 kV in current mode	
Assigned industrial frequency magnetic field (IEC61000-4-8)	30 A/m	
Voltage dips, short interruptions and voltage variations (IEC61000-4-11)	0% U_T for 0.5 cycles (0°, 45°, 90°, 135°, 180°, 225°, 270° and 315° for 0.5 cycle) 0% U_T for 1 cycle 70% U_T For 25 cycles at 50 Hz For 30 cycles at 60 Hz Single phase: 0°	Environment of a professional healthcare facility. If using the system requires continued operation during power cuts, it is recommended that the medical device be supplied with a separate power source (UPS, etc.).
Voltage Interruptions (IEC61000-4-11)	0% U_T for 250 cycles at 50Hz for 300 cycles at 60Hz	



U_T is the AC mains voltage before applying the test level.

e. Electromagnetic immunity, radio frequencies



The product is intended for use in the electromagnetic environment specified below. It is up to the customer or the user to verify that the instrument is used in this environment.

Portable RF communications devices (including devices such as antenna cables and external antennas) should not be used closer than 30 cm (12 inches) to any part of the device under test, including cables specified by the manufacturer. Otherwise, the performance of these devices could be affected.

IMMUNITY TEST	TEST LEVEL IEC 60601 & COMPLIANCE LEVEL	ELECTROMAGNETIC ENVIRONMENT – GUIDELINES
Electromagnetic fields radiated radio frequency (IEC61000-4-3)	3 V/m 80 MHz to 2.7 GHz 80% MA at 1 kHz	Occupational healthcare facility.
Proximity Fields emitted by RF Wireless Communications Devices (IEC 61000-4-3 Interim Method)	V/m 710 MHz, 745 MHz, 780 MHz, 5240 MHz, 5550 MHz, 5785 MHz, 27 V/m 385 MHz 28 V/m 450 MHz, 810 MHz, 870 MHz, 930 MHz, 1720 MHz, 1845 MHz, 1970 MHz, 2450 MHz,	

Field-induced conducted disruptions RF (IEC610004-6)	3 V 150 Khz to 80 MHZ 6 V in ISM frequency and band between 0.15 MHz and 80 MHz, amateur radio frequency including 80% MA at 1 KHz	
--	--	--

XIII. TROUBLESHOOTING

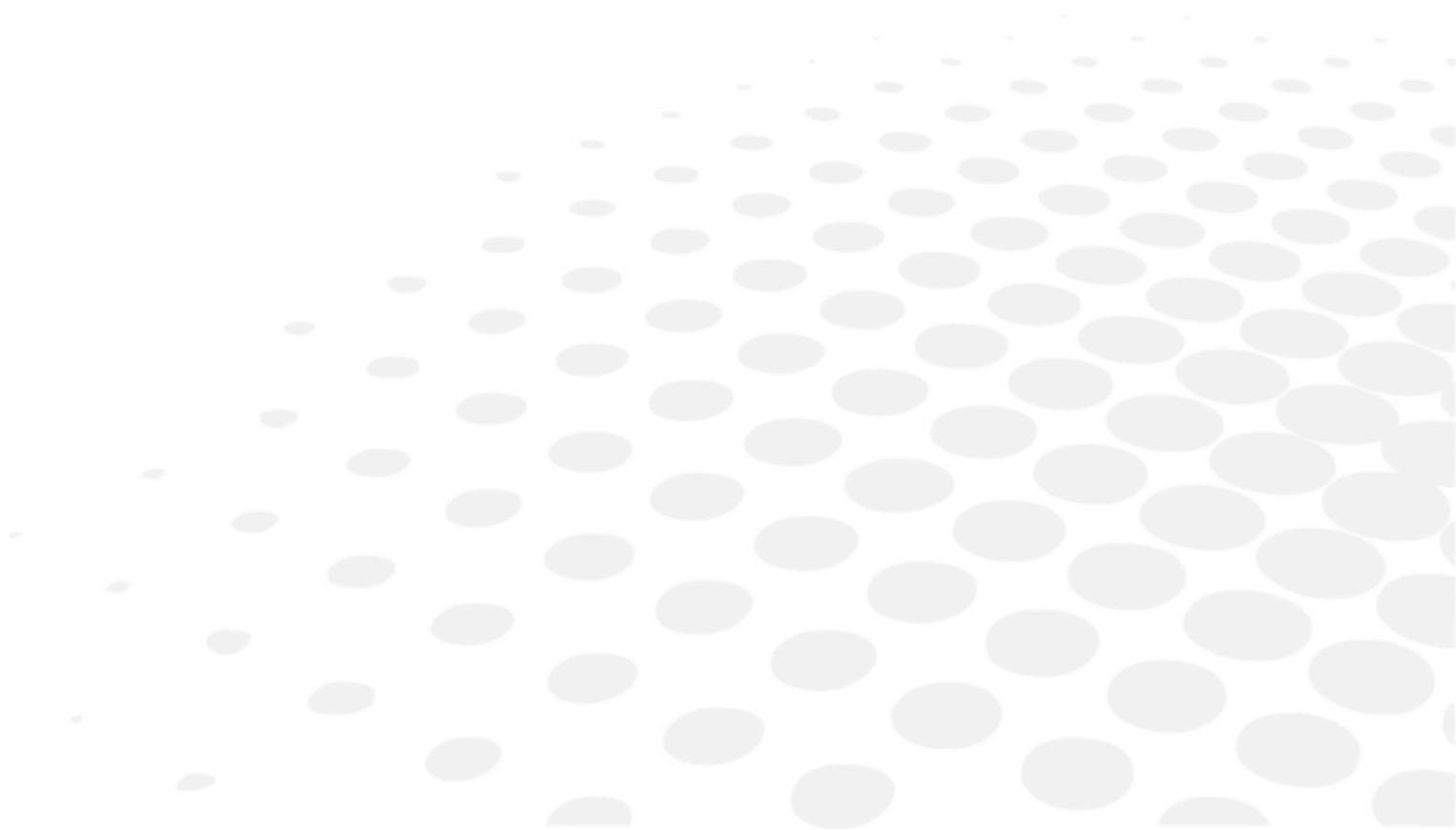

If a problem is detected, refer to the table below in order to take the appropriate measures.

SYMPTOMS	CAUSES AND MEASUREMENTS
The refraction head does not initialize itself	<ul style="list-style-type: none"> • No power <ul style="list-style-type: none"> ◦ Check that the USB cable connected to the power supply is connected (cable + extension) ◦ Check that the power supply block is on
The console does not initialize itself	<ul style="list-style-type: none"> • No power <ul style="list-style-type: none"> ◦ Check that the power supply block is on ◦ Check that [Bluetouch] is on ◦ Press on the [Clear] key to start initialization
No supply to the power supply box	<ul style="list-style-type: none"> • No power <ul style="list-style-type: none"> ◦ Check that the [ON/OFF] switch is set to ON ◦ Check that the first LED on the power supply box is on
Frozen console screen	<ul style="list-style-type: none"> • No power <ul style="list-style-type: none"> ◦ Check mains lead is connected ◦ Turn the console off with the [Clear] switch and restart the product
Rainbow on the screen	<ul style="list-style-type: none"> • Video cable error <ul style="list-style-type: none"> ◦ Check that the console cable is plugged into the power supply block
Keyboard screen does not switch on and stays black when initializing	<ul style="list-style-type: none"> • Bluetouch lights up <ul style="list-style-type: none"> ◦ Change the cable from console or change the power supply • Bluetouch does not lights up <ul style="list-style-type: none"> ◦ Change the power supply • Bluetouch lights up then turns OFF <ul style="list-style-type: none"> ◦ Change the console or change the refraction head

If the problem has not been resolved after taking the measures listed above, contact your local distributor immediately. Your dealer has been trained by Essilor.

XIV. MAINTENANCE

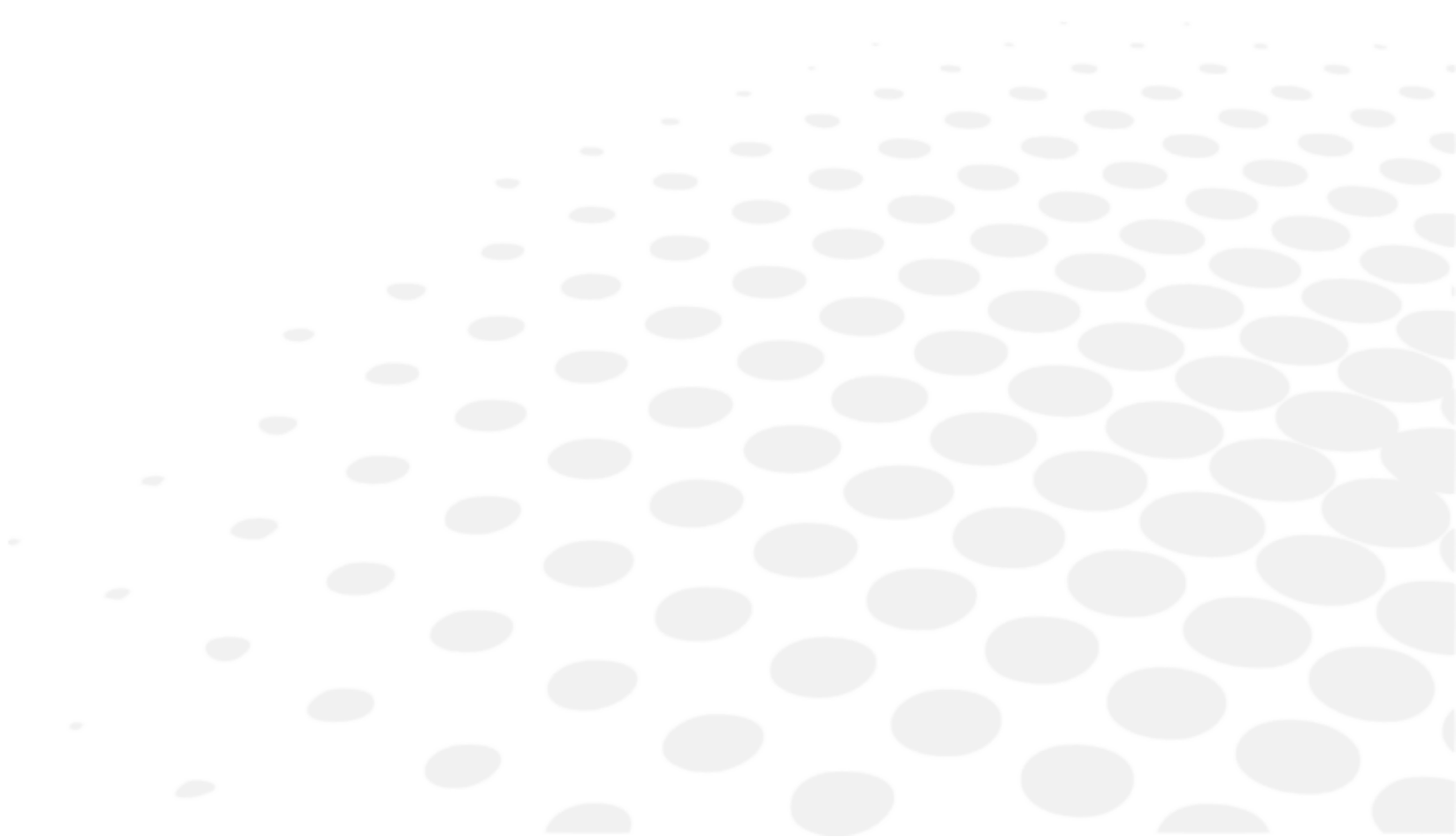



- In order to ensure safety and the performance of the instrument, all maintenance operations, unless otherwise specified in this manual, must be carried out by qualified maintenance technicians.
- This instrument is a high precision optical device. Handle it carefully at all times.
- Take care to handle the instrument carefully in order to avoid any scratches (covers for example).
- Do not touch the optical parts (the observation window for example) with your fingers, and take care to clean off any dust buildup which would be likely to distort the result of measurements.
- If you find that this device is dirty, you can clean it as often as you want (see after the specific cleaning methods).
- Do not use benzene, thinners, organic solvents, ether or gasoline to clean the instrument.

1. Storage and handling condition



Respect the operating, storage and transport conditions noted below.

Avoid condensation conditions.

	Temperature	Humidity	Atmospheric pressure
Use	[+15°C; +30°C]	[30 %; 90 %]	[800 hPA; 1060 hPA]
Storage	[- 10°C; + 55°C]	[10 %; 95 %]	[700 hPA; 1060 hPA]
Transport	[- 40°C; + 70°C]	[10 %; 95 %]	[700 hPA; 1060 hPA]

2. Cleaning



To avoid any incident, unplug the instrument before cleaning.

Essilor will make available on request circuit diagrams, component part lists, descriptions, calibration instructions, or other information that will assist the dealer to repair those parts of this device that are designated by ESSILOR as repairable by the dealer.

a. Cleaning and disinfection the head



- To disinfect the areas likely to be in contact with the patient (face shields and forehead rest cover), use disinfectant wipes for medical use.
- Disinfect these areas between testing each patient.



Always use a slightly damp soft cloth (microfiber, silicone), to clean the elements of the head:

- The face shields by removing them beforehand
- The optics
 - patient side (only if a trace is identified)
 - practitioner side
- The camera window for near-vision distance measurements
- The camera windows for Vertex distance measurements
- The LED panel

Do not clean the observation windows (patient side) with liquid, nor with a compress held in a clamp or a screwdriver to prevent damage of the optical surfaces.



To clean the SCV modules (patient side observation windows):

The SCV modules need to be checked after each patient. Visually check if traces of dirt are present on the rear window of the SCV module (patient side).

1. Take one of the cleaning swab (provided with the product).
 - > Change the cleaning swab for the second module.
 2. Spray Isopropyl alcohol (cleaner, antiseptic and disinfectant) on the tip (white part) of the cleaning swab.
 - > Do not dip or soak the cleaning swab directly in alcohol.
 3. Fold the nozzle, in order to have a larger cleaning surface.
 4. Apply the tip in the center of the module and clean the module with a circular motion (snail types).
 - > Spiral movement from the center to the outside of the module.
- Do not use wipe
 - Do not use a tool to clean (screwdriver, pen tip)
 - Do not clean directly with your fingers

b. Cleaning the console



Always use a slightly damp soft cloth (microfiber, silicone), to clean the elements of the console:

- The touch screen
- The keyboard

Do not spray liquid on the touch screen or the keyboard of the console, regardless of the liquid, in order not to risk damaging the electronic boards.

3. Periodical inspection and maintenance



- Inspect the instrument (once a week) to ensure that it is assembled correctly and the console is properly connected.
- Check the tightening of the M6 screw that attaches the head to the phoropter arm.
- Check the tightening of the M5 safety screw (through screw in the phoropter arm).
- If the cover is dirty, gently wipe it with a soft, slightly damp cloth. Wipe any stubborn stains with a little water or neutral detergent.

M6 screw (located above)



M5 screw (located below)



4. Disassembly of the product and transport

This section is not applicable.

5. Disposal



Instructions for the disposal of the instrument in accordance with Directives 2012/19/EU and 2011/65/EU regarding the limitation of dangerous substances in electrical and electronic equipment and the disposal of electrical and electronic waste.

When it reaches the end of its lifetime, the instrument should not be thrown out with the household refuse. It can be disposed of at a waste management center operated by the municipality or the retailers who offer this service.

The separate disposal of an electrical device avoids any damage to the environment or health that could result from a non-compliant disposal, and also allows the materials it is composed of to be recycled in order to save energy and resources.

The pictogram of the wheeled container appears on the label of the instrument. It indicates the obligation for separate collection and disposal of end-of-life/out-of-use electrical and electronic equipment.



- The user must take into account the potentially harmful effects on the environment and human health that could result from the non-compliant disposal of the instrument in its entirety or some of its components.
- To avoid the release of dangerous substances into the environment and to encourage the preservation of natural resources, the manufacturer facilitates, in the event that the user wishes to dispose of the instrument at the end of its lifespan, the reuse, recovery and recycling of the instrument and its components. Before disposing of the instrument, the requirements of European and national regulations must be taken into consideration.
- Do not dispose of the instrument with household waste, but dispose of it separately by giving it in a company specialized in the disposal of electrical and electronic equipment or at the local administrative services in charge of waste collection.
- The supplier or manufacturer is required to recover the old equipment.
- By joining a consortium for the waste of technological equipment, the manufacturer covers the treatment and recycling costs of the used instrument.
- The manufacturer undertakes to provide the user with all the information relating to the dangerous substances contained in the device and the methods of recycling these substances, and to inform them of the existence of recycling of the used equipment. The law provides for severe penalties in case of infringement.

XV. SPECIFICATIONS

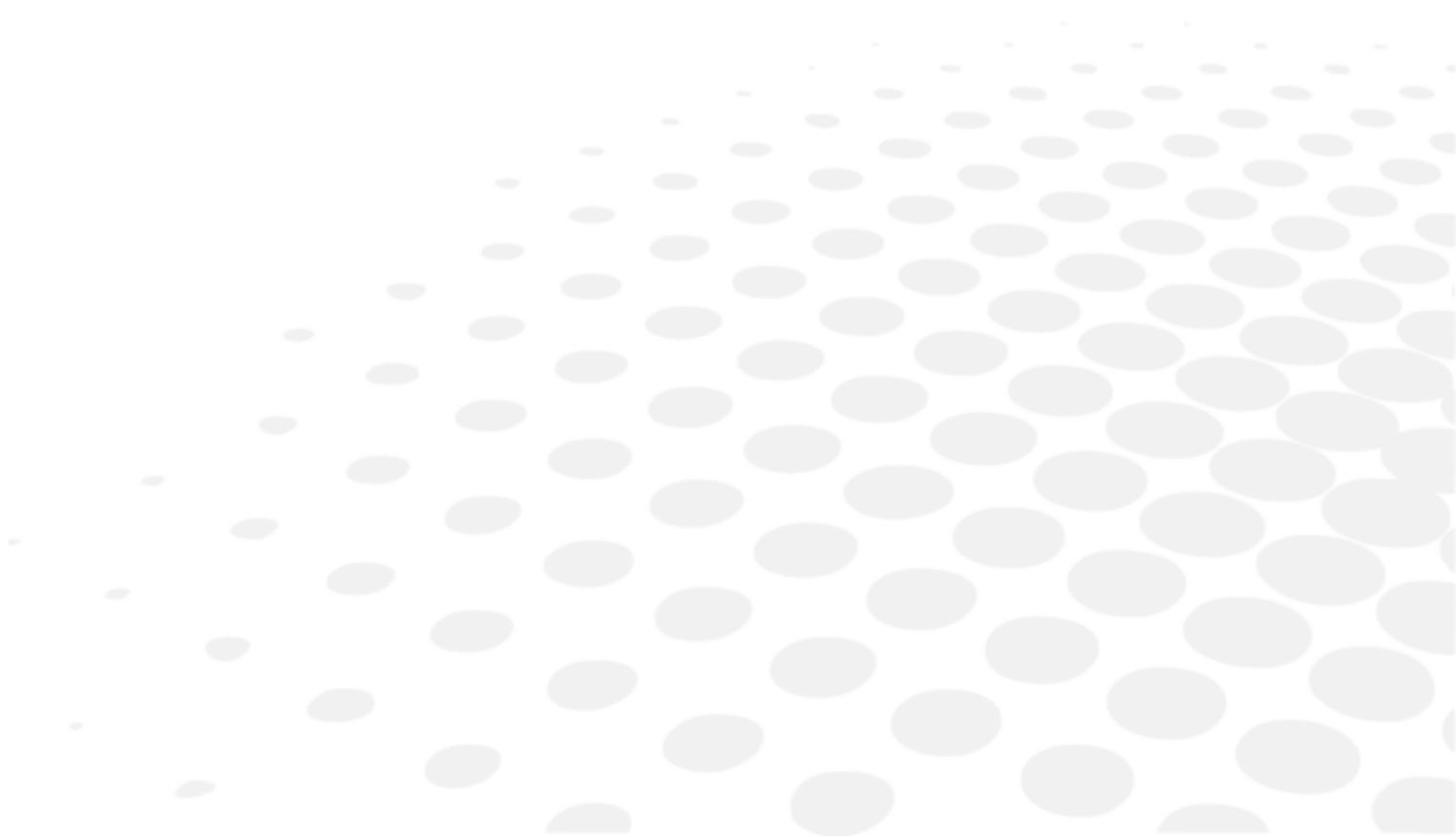

1. Technical data

The expected life of the device and its components is 7 years.

a. Centering

- Interpupillary distance:
 - 49.0 to 80.0 mm at far distance (in 0.50 mm steps)
 - 55.0 to 83.0 mm at near distance (in 0.50 mm steps)
- Binocular and monocular adjustments
- Convergence: automatic, compared to the position of the target for near vision and to the patient's pupillary distance
- Vertex distance: from 4.0 to 30.0 mm in 0.1 mm steps, monocular, measured by cameras

b. Measurement range

- Sphere: from -20.00 D to +20.00 D
- Cylinder: up to 8.00 D depending on the lens combination. Cylinder from -7.00 D to 8.00 D with sphere at 0 D
 - In "Standard" mode: 0.25 D increments with adjustable steps
 - In "Intelligent" mode: 0.01 D resolution or multiple larger and smaller steps which rounds to 0.25 D
- Axis: 0° to 180° in 1° increments, with adjustable steps
- Prism: 0 to 20 Δ in 0.1 Δ increments, with adjustable steps

c. Auxiliary lenses

- Occluders: dark
- Pin hole: yes
- Retinoscopic lenses: +1.50 D, +2.00 D (powered by optical module)
- Fog lenses: +1.50 D, +2.00 D (powered by optical module)
- Jackson cross cylinders: +/- 0.25 D, +/- 0.50 D (powered by optical module)
- Fixed cross cylinders: +/- 0.50 D (powered by optical modules)
- Prisms:
 - 3 Δ base up / 3 Δ base down
 - 6 Δ base up
 - 10 Δ base in (powered by varying prisms / diasporameters)
- Maddox rods: red, horizontal and vertical
- Red/Green filters: red on right eye, green on left eye
- Polarized filter: both linear and circular

d. Dimensions and weight

- Refraction head:
 - Width: 29.6 cm at top - 20.1 cm / 23.9 cm at bottom / height= 22.2 cm
 - Depth: 8.4 cm at top - 6.5 cm at bottom
 - Total weight: 3.5 Kg
- Console (keyboard + screen):
 - Keyboard: (W) 28 cm x (D) 22 cm x (H) 23.5 cm
 - Screen display: 10.4"
 - Total weight: 3.0 Kg

- Power supply:
 - Length: 16.5 cm
 - Width: 19.3 cm
 - Depth: 5.6 cm
 - Total weight : 1.0 Kg

e. LEDs

- Near-vision lighting:
 - Colour: white, neutral
 - Chromaticity CCT: 4000 K
 - Flux: 93.9 lm
 - Class: NC
- Visible white LED (Vertex distance):
 - Colour: sunrise
 - Chromaticity CCT: 2700 K
 - Flux: 8 lm to 120°
 - Class: NC
- Infra-red LED:
 - Color: IR
 - Wavelength: 850nm
 - Energy intensity: 50mW/Sr
 - Class: NC
- Infra-red LED (call up tests display on screen):
 - Color: IR
 - Wavelength: 940 nm
 - Energy intensity: 145mW/Sr
 - Class: NC

f. Input/Output

- Power supply box:
 - AC input 100-240V; 50/60 Hz; 1,2-0,5A
 - DC output: 24V
 - Power output: 48 VA
- Refraction head: AC input 24V, 48VA
- Console: AC input 24V, 48VA

2. Connectivity to other devices

This section is not applicable.

3. It requirements

This section is not applicable.

XVI. QR CODE

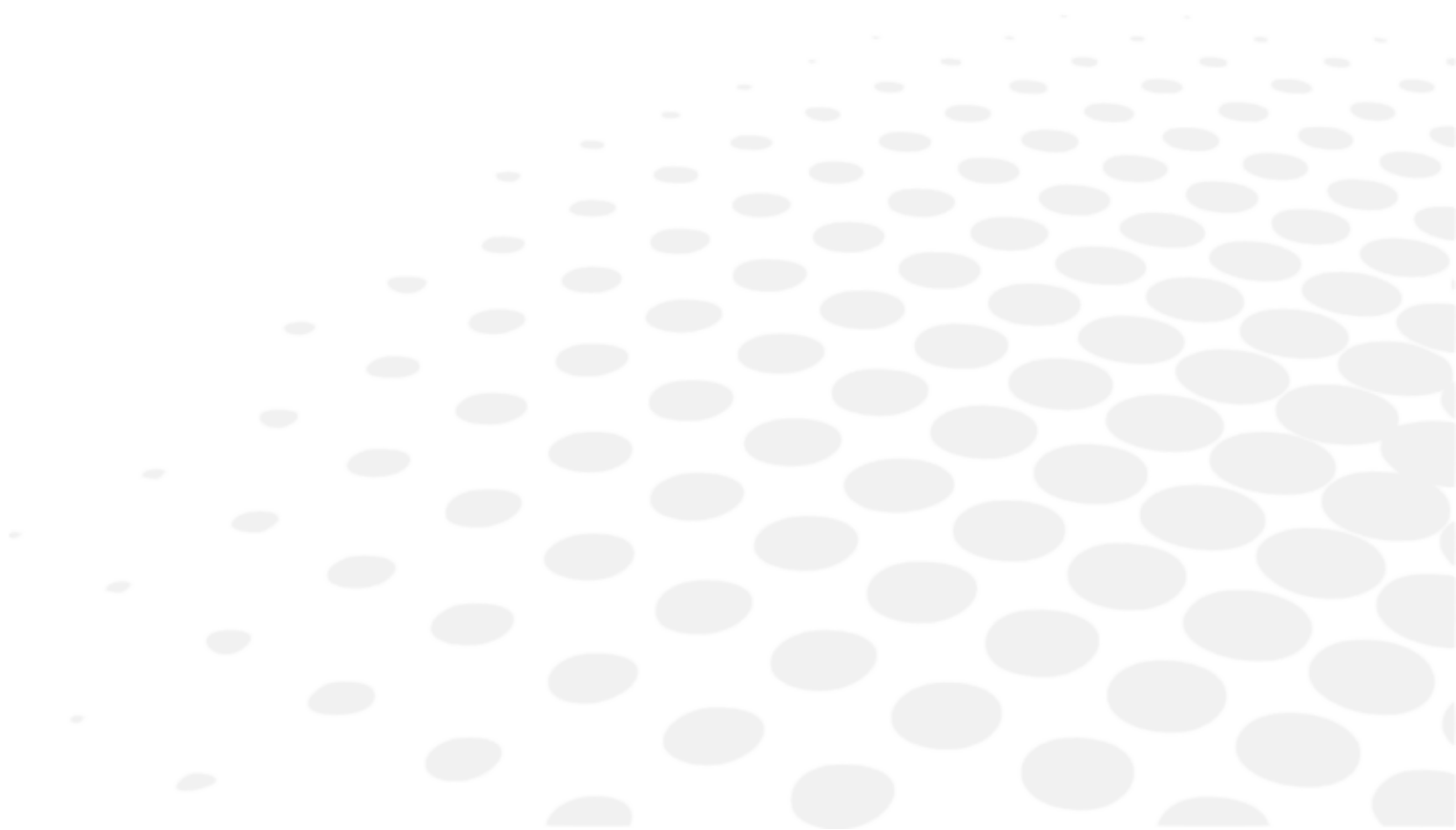

The latest version of the user manual in the appropriate language is available on a web space. Upon request, a paper version can be provided for free.

- en The complete user manual is available on a web space in PDF format. To access it, please scan the QR code below using a dedicated tool or application. Please make sure that your device is suitable and has an appropriate software to display the electronic Instructions for use.
- fr Le manuel utilisateur complet est disponible sur un espace web au format PDF. Pour y accéder, veuillez scanner le QR code ci-dessous à l'aide d'un outil ou d'une application dédié(e). Veuillez vous assurer que votre appareil est compatible et dispose d'un logiciel approprié pour afficher le manuel électronique.
- ar لتتمكن من الوصول إليه، يُرجى مسح رمز الاستجابة السريعة أدناه باستخدام أداة أو تطبيق PDF. دليل المستخدم الكامل متوفر من خلال موقع الويب بصيغة مخصص لذلك. يُرجى التأكد من أن جهازك مناسب ويحتوي على برنامج مناسب لعرض التعليمات الإلكترونية الخاصة بالاستخدام.
- be Поўная інструкцыя карыстальніка даступна ў інтэрнэт-прасторы у фармаце PDF. Каб атрымаць да яе доступ, адсканіруйце QR-код ніжэй пры дапамозе спецыяльнага сродку або праграмы. Калі ласка, упэўніцеся, што ваша прылада прыдатная для паказу электроннай Інструкцыі па карыстанню і што на ёй усталявана адпаведнае праграмае забеспячэнне.
- bg Пълното ръководство за потребителя е достъпно в уеб пространството. За да получите достъп до него, моля, сканирайте QR кода по-долу, като използвате специален инструмент или приложение. Моля, уверете се, че вашето устройство е подходящо и разполага с подходящ софтуер за преглед на електронните Инструкции за употреба.
- cs Kompletní uživatelský návod je k dispozici na webovém prostoru ve formátu PDF. Chcete-li k němu získat přístup, naskenujte prosím níže uvedený QR kód pomocí speciálního nástroje nebo aplikace. Ujistěte se prosím, že používáte vhodné zařízení, které má vhodný software pro zobrazení elektronického uživatelského návodu.
- da Den komplette brugervejledning er tilgængelig på et webområde i PDF-format. For at få adgang til den skal du scanne QR-koden nedenfor ved hjælp af et dedikeret værktøj eller program. Sørg for, at din enhed er egnet og har en passende software til at vise de elektroniske brugsanvisninger.
- de Die vollständige Bedienungsanleitung ist auf einem Webespace im PDF-Format verfügbar. Für den Zugriff scannen Sie bitte den untenstehenden QR-Code mit einem speziellen Tool oder einer Anwendung. Bitte vergewissern Sie sich, dass Ihr Gerät für die Anzeige der elektronischen Gebrauchsanweisungen geeignet ist und über eine entsprechende Software verfügt.
- el Το πλήρες εγχειρίδιο χρήσης είναι διαθέσιμο σε έναν ιστοχώρο σε μορφή PDF. Για να αποκτήσετε πρόσβαση σε αυτό, σκανάρετε τον κωδικό QR παρακάτω χρησιμοποιώντας ένα ειδικό εργαλείο ή εφαρμογή. Βεβαιωθείτε ότι η συσκευή σας είναι κατάλληλη και έχει το κατάλληλο λογισμικό για την προβολή των ηλεκτρονικών οδηγιών χρήσης.
- es El manual de uso completo está disponible en un espacio web. en formato PDF. Para acceder a él, escanee el código QR debajo utilizando una herramienta o aplicación dedicada. Asegúrese de que su dispositivo sea adecuado y tenga el software apropiado para mostrar las Instrucciones de uso electrónicas.
- et Täielik kasutusjuhend on saadaval veebis PDF-vormingus. Juurdepääsuks palun skannige allolevat QR-koodi, kasutades selleks vastavat tööriista või rakendust. Veenduge, et teie seade sobib ja et selles on elektroonilise kasutusjuhendi kuvamiseks sobiv tarkvara.
- fi Täysi käyttöopas on saatavana verkosta PDF-muodossa. Saat pääsyn siihen skannaamalla alla olevan QR-koodin käyttäen siihen tarkoitettu työkalua tai sovellusta. Varmista, että laitteesi on sopiva ja sisältää asianmukaisen ohjelmiston sähköisten käyttöohjeiden esittämiseen.
- hr Potpun korisnički priručnik dostupan je na mrežnom prostoru u PDF formatu. Da biste mu pristupili, skenirajte QR kod u nastavku pomoću odgovarajućeg alata ili aplikacije. Provjerite je li vaš uređaj prikladan i ima li odgovarajući softver za prikaz elektroničkih uputa za upotrebu.
- hu A teljes felhasználói kézikönyv elérhető az interneten PDF formátumban. Eléréséhez olvassa be az alábbi QR-kódot egy erre szolgáló eszközzel vagy alkalmazással. Ellenőrizze, hogy eszköze képes és rendelkezik a megfelelő szoftverrel az elektronikus használati útmutató megjelenítésére.

id	<p>Panduan pengguna lengkap tersedia di ruang web dalam format PDF. Untuk mengaksesnya, silakan pindai kode QR di bawah ini menggunakan alat atau aplikasi khusus. Pastikan peranti Anda sesuai dan memiliki perangkat lunak yang layak untuk menampilkan petunjuk penggunaan elektronik.</p>
it	<p>Il manuale utente completo è disponibile in formato PDF su uno spazio Web. Per accedervi, leggere il codice QR sottostante mediante un apposito strumento o un'applicazione dedicata. Assicursi che il dispositivo sia adatto e che disponga di un software appropriato per visualizzare le istruzioni per l'uso in formato elettronico.</p>
ja	<p>完全なユーザーマニュアルは、PDF形式でウェブスペースから入手できます。アクセスするには、専用のツールまたはアプリケーションを使用して、以下のQRコードをスキャンしてください。お使いのデバイスが適切であり、電子説明書を表示する適切なソフトウェアがインストールされていることを確認してください。</p>
ko	<p>전체 사용 설명서는 웹 공간에 PDF 형식으로 있습니다. 이 설명서에 액세스하려면, 전용 도구 또는 앱을 사용하여 아래 QR 코드를 스캔하십시오. 사용자의 기기가 적합하고 전자적인 사용 설명서를 표시할 수 있는 적절한 소프트웨어가 있는지 확인하시기 바랍니다.</p>
lt	<p>Išsamaus naudotojo vadovo PDF formatu ieškokite interneto svetainėje. Kad jį atvertumėte, specialiu įrankiu arba programėle nuskaitykite toliau pateiktą QR kodą. Įsitinkite, kad jūsų įrenginys yra tinkamas ir turi tinkamą programinę įrangą elektroninems naudojimo instrukcijoms rodyti.</p>
lv	<p>Pilnā lietotāja instrukcija ir pieejama tīmeklī PDF formātā. Lai tai piekļūtu, lūdzu, noskenējiet tālāk redzamo kvadrātkodu, izmantojot tam paredzētu rīku vai lietojumprogrammu. Lūdzu, pārlicinieties, vai jūsu ierīce ir piemērota un vai tai ir atbilstoša programmatūra elektroniskās lietotāja instrukcijas attēlošanai.</p>
ms	<p>Manual pengguna yang lengkap boleh didapati di ruang laman dalam format PDF. Untuk mengaksesnya, sila imbas kod QR di bawah menggunakan alat atau aplikasi khusus. Sila pastikan yang peranti anda adalah serasi dan mempunyai perisian yang sesuai untuk memaparkan Arahan elektronik untuk tujuan penggunaan.</p>
nl	<p>De volledige gebruikershandleiding is in PDF-formaat beschikbaar op een website. U kunt de handleiding bereiken door de QR-code hiernaast te scannen met een geschikte applicatie. Uw apparaat moet geschikt zijn en over de juiste software beschikken om de elektronische gebruiksaanwijzing weer te geven.</p>
no	<p>Den komplette brukerhåndboken er tilgjengelig på et webhotell i PDF-format. For å få tilgang til den, skann QR-koden nedenfor ved hjelp av et dedikert verktøy eller applikasjon. Sørg for at enheten din er egnet og har en passende programvare for å vise den elektroniske bruksanvisningen.</p>
pl	<p>Kompletna instrukcja użytkownika jest dostępna na stronie internetowej w formacie PDF. Aby uzyskać dostęp, zeskanuj poniższy kod QR przy użyciu dedykowanego narzędzia lub aplikacji. Upewnij się, że urządzenie jest zgodne i wyposażone w odpowiednie oprogramowanie pozwalające wyświetlać elektroniczną Instrukcję obsługi.</p>
pt	<p>O manual do utilizador completo está disponível num espaço online no formato PDF. Para aceder a este, queira digitalizar o QR Code abaixo usando uma ferramenta ou uma aplicação dedicada. Certifique-se de que o seu dispositivo é compatível e possui um software apropriado para exibir as instruções eletrónicas de utilização.</p>
pt (brazil)	<p>O manual do usuário completo está disponível em um espaço online no formato PDF. Para acessar a este, por favor, digitalizar o QR Code abaixo usando uma ferramenta ou um aplicativo dedicado. Seu dispositivo deve ser compatível e possuir um software apropriado para exibir as instruções eletrônicas de utilização.</p>
ro	<p>Manualul de utilizare complet este disponibil online în format PDF. Pentru a-l accesa, scanați codul QR de mai jos folosind un instrument sau o aplicație dedicată. Asigurați-vă că dispozitivul dumneavoastră este potrivit și are un software adecvat pentru afișarea Instrucțiunilor de utilizare în format electronic.</p>
ru	<p>Полное руководство пользователя доступно в интернет-пространстве в формате PDF. Чтобы получить к нему доступ, отсканируйте QR-код ниже с помощью специального инструмента или приложения. Убедитесь, что ваше устройство подходит и имеет соответствующее программное обеспечение для отображения электронных инструкций по эксплуатации.</p>
sk	<p>Celý používateľský manuál je dostupný vo webovom priestore vo formáte PDF. Ak chcete získať prístup, naskenujte nižšie uvedený QR kód pomocou špeciálneho nástroja alebo aplikácie. Uistite sa, že máte vhodné zariadenie s vhodným softvérom na zobrazenie elektronickeho návodu na použitie.</p>

- sl Celoten uporabniški priročnik je na voljo kot dokument PDF na spletnem mestu. Za dostop optično preberite spodnjo kodo QR z namenskim orodjem ali aplikacijo. Prepričajte se, da je vaša naprava primerna in ima ustrezno programsko opremo za prikaz elektronskih navodil za uporabo.
- sr Kompletно uputstvo za korisnike je dostupno na veb prostoru u PDF formatu. Da biste mu pristupili, skenirajte QR kôd u nastavku pomoću namenske alatke ili aplikacije. Proverite da je vaš uređaj odgovarajući i da li ima potreban softver za prikaz elektronskog Uputstva za upotrebu.
- sv Den fullständiga bruksanvisningen finns tillgänglig på ett webbutrymme i PDF-format. För att komma åt den, vänligen skanna QR-koden nedan med ett dedikerat verktyg eller program. Se till att din enhet är lämplig och har en passande programvara för att visa de elektroniska användningsinstruktionerna.
- th สามารถรับคู่มือผู้ใช้ฉบับสมบูรณ์ในรูปแบบ PDF ได้จากบนเว็บไซต์ โดยในการเข้าถึง โปรดสแกนคิวอาร์โค้ดด้านล่างด้วยเครื่องมือหรือแอปพลิเคชันเฉพาะ โปรดตรวจสอบให้แน่ใจว่าอุปกรณ์ของคุณนั้นเหมาะสม และมีซอฟต์แวร์ที่สามารถใช้ในการแสดงคำแนะนำการใช้งานอิเล็กทรอนิกส์ได้อย่างถูกต้อง
- tr Kullanım kılavuzunun tamamı web alanında, PDF formatında mevcuttur. Buna erişmek için lütfen uygun bir araç veya uygulama kullanarak aşağıdaki QR kodunu okutun. Lütfen cihazınızın uyumlu ve elektronik kullanım talimatlarını görüntülemek için uygun bir yazılıma sahip olduğundan emin olun.
- uk Повна версія посібника користувача доступна в інтернеті в форматі PDF. Щоб отримати до нього доступ, скануйте QR-код нижче за допомогою спеціального додатку. Для перегляду електронного посібника користувача на вашому пристрої він повинен мати відповідні характеристики та програмне забезпечення.
- vi Hướng dẫn sử dụng đầy đủ có sẵn trên không gian web ở định dạng PDF. Để truy cập, vui lòng quét mã QR bên dưới bằng công cụ chuyên dụng hoặc bằng ứng dụng. Vui lòng đảm bảo rằng thiết bị của bạn phù hợp và có phần mềm phù hợp để hiển thị Hướng dẫn sử dụng điện tử
- zh 完整的操作手册以 PDF 格式在网络上提供。如需获取，请使用专门的工具或应用程序扫描下方二维码。请确保您的设备适用并安装有相应的软件，能够显示电子版使用说明。





Essilor International
147, rue de Paris – 94220 Charenton-le-Pont France
www.essilor.com

