

# VISION-R™ 800



## USER MANUAL

# CONTENTS

|  |           |
|--|-----------|
| <b>I. INTRODUCTION</b>   | <b>6</b>  |
| <b>II. SUPPLY PACKAGE</b>  | <b>8</b>  |
| 1. Unpacking and storage   | 9         |
| 2. List of accessories   | 9         |
| a. Standard accessories  | 9         |
| b. Optional accessories  | 9         |
| c. Detachable parts  | 9         |
| <b>III. GENERAL DESCRIPTION</b>                                    | <b>10</b> |
| 1. Intended use  | 11        |
| a. Intended purpose  | 11        |
| b. Indications for use   | 11        |
| c. Expected clinical benefit                                       | 11        |
| d. Intended population   | 11        |
| e. Intended users  | 11        |
| 2. Device description  | 11        |
| a. Refraction head - (Ref. V01012)                                 | 12        |
| b. Console - (Ref. V01KB1)   | 13        |
| c. Power supply box - (Ref. V01PS1)                                | 14        |
| d. Test presentation screen  | 15        |
| <b>IV. INSTALLATION / CONNECTION</b>                               | <b>16</b> |
| 1. Installation of the device                                      | 17        |
| 2. Turning ON/OFF  | 17        |
| a. Turn on the instrument  | 17        |
| b. Turn off the instrument   | 18        |
| 3. Connection to other instruments                                 | 18        |
| <b>V. ADJUSTMENTS BEFORE THE EXAMINATION</b>                       | <b>19</b> |
| 1. Configure the instrument  | 20        |
| a. Set the instrument data to zero                                 | 20        |
| b. Pass from the manual mode to the automatic mode                 | 21        |
| c. Import and export data  | 21        |
| 2. Setting up the patient  | 22        |
| a. Adjusting the horizontality of the refraction head              | 22        |
| b. Adjusting the inter-pupillary distances                         | 22        |
| c. Adjusting the forehead rest                                     | 23        |
| d. Going from far-vision mode to near-vision mode                  | 24        |
| <b>VI. BASIC FUNCTIONS FOR PERFORMING A REFRACTION EXAMINATION</b> | <b>26</b> |
| 1. Choose a test   | 27        |
| a. Select a test   | 27        |
| b. Start an existing test program                                  | 28        |
| 2. Checking the optical module                                     | 30        |
| a. Changing the checked eye  | 30        |
| b. Change the controlled settings                                  | 30        |
| c. Modify the power and the incrementation steps                   | 31        |
| d. Modify the incrementation steps                                 | 32        |
| e. Value locking function  | 33        |
| 3. Mask an eye and check the filters                               | 34        |
| a. Check the masks   | 34        |

|  |            |
|--|------------|
| b. Check and modify the filters                                  | 34         |
| c. Modify the type of occlusion                                  | 35         |
| 4. View exported data at the end of the exam                     | 36         |
| 5. Manage the patient data                                       | 38         |
| a. Add a patient folder  | 38         |
| 6. Access with contextual assistance                             | 39         |
| <b>VII. PERFORMANCE OF TESTS DURING A REFRACTION EXAMINATION</b> | <b>41</b>  |
| 1. Patient refraction data input                                 | 42         |
| a. Objective   | 42         |
| b. Data importing from Essibox.com                               | 42         |
| c. Manual entry  | 43         |
| 2. Standard tests  | 46         |
| a. Refraction tests  | 46         |
| b. Near vision tests   | 71         |
| 3. Smart tests   | 71         |
| a. Refraction tests  | 72         |
| 4. Refraction to Prescription [PVP]                              | 77         |
| 5. Refraction comparison (Bluetouch)                             | 79         |
| a. Alert function in the comparison screen                       | 82         |
| <b>VIII. VERTEX DISTANCE MEASUREMENT</b>                         | <b>84</b>  |
| <b>IX. REFRACTION PROGRAMS</b>                                   | <b>88</b>  |
| 1. Standard programs   | 89         |
| 2. Customized programs   | 89         |
| a. Editing and customizing programs and tests                    | 89         |
| b. Favorite tests selection                                      | 96         |
| <b>X. INSTRUMENT SETTINGS</b>                                    | <b>99</b>  |
| 1. General information   | 100        |
| 2. Measurement data  | 103        |
| 3. Import/Export data  | 106        |
| 4. Communication settings  | 110        |
| 5. Local settings  | 112        |
| 6. Backups restore   | 114        |
| <b>XI. ERROR DISPLAY</b>   | <b>116</b> |
| <b>XII. SAFETY CONSIDERATION</b>                                 | <b>118</b> |
| 1. Symbols (document, device & packaging)                        | 119        |
| a. On the document   | 119        |
| b. On the device and packaging                                   | 119        |
| 2. Precautions for use   | 120        |
| 3. Contraindication  | 121        |
| 4. Side effects  | 121        |
| 5. Exclusion of liability clause                                 | 121        |
| 6. Power source  | 122        |
| 7. Precautions regarding IT Network                              | 123        |
| 8. Electromagnetic compatibility                                 | 123        |
| a. Length of cables, cords, etc.                                 | 124        |
| b. Recommended separation distance                               | 124        |
| c. Electromagnetic emissions                                     | 124        |
| d. Magnetic and electromagnetic immunity                         | 124        |
| e. Electromagnetic immunity, radio frequencies                   | 125        |

|  |            |
|--|------------|
| <b>XIII. TROUBLESHOOTING</b>   | <b>126</b> |
| <b>XIV. MAINTENANCE</b>  | <b>128</b> |
| 1. Storage and handling condition  | 129        |
| 2. Cleaning  | 129        |
| a. Cleaning and disinfection the head  | 129        |
| b. Cleaning the console  | 130        |
| 3. Periodical inspection and maintenance                                       | 130        |
| 4. Disassembly of the product and transport                                    | 130        |
| 5. Disposal  | 131        |
| <b>XV. SPECIFICATIONS</b>  | <b>132</b> |
| 1. Technical data  | 133        |
| a. Centering   | 133        |
| b. Measurement range   | 133        |
| c. Auxiliary lenses  | 133        |
| d. Dimensions and weight   | 133        |
| e. LEDs  | 134        |
| f. Input/Output  | 134        |
| 2. Connectivity to other devices   | 134        |
| 3. It requirements   | 134        |
| <b>XVI. ANNEX</b>  | <b>135</b> |
| 1. Frequently Asked Questions  | 136        |
| a. What is the point of determining the refraction with a precision of 0.01 D? | 136        |
| b. Can patients really notice refraction changes below 0.25 D?                 | 136        |
| <b>XVII. QR CODE</b>   | <b>137</b> |



# I. INTRODUCTION





The latest version of this user manual is available on a web space.  
To access other available languages, please scan the QR code available at the end of this user manual > QR Code Chapter (p. 137).

For a safer, more effective use, follow the instructions outlined in this manual.

Copyright © 2021 Essilor - Original manual All rights reserved.

All reproduction of the content of this document, whether in part or as a whole, for the purpose of its publication or dissemination by any means and in any format whatsoever, even free of charge, is strictly prohibited without Essilor's prior written consent

## II. SUPPLY PACKAGE



## 1. Unpacking and storage

This section is not applicable.

## 2. List of accessories

While unpacking, check that the following standard accessories are included.

### a. Standard accessories

- Communication cables:
  - 1 electric cable running from the refraction head (2 m) with a 1 extension (2 m)
  - 1 electric cable running from the console (7 m)
  - 2 CBOX/Vision-R™ 800 network cables running to the local network
- Face shield, ref V01S47 (x2)\*
- Forehead rest (x1)
- Forehead rest cover, ref V0122G (x2)\*
- Near vision test chart with near vision test bar (70 cm) and near vision test chart, ref V01S50
- Screw attachment of the head M6 (x1), mounted on the arm
- Screw of safety M5 (x1)
- M4 (x1) and M5 (x1) Allen key
- 16 Gb USB key, ref CE7781
- Protective cover:
  - Refraction head, ref V01A01 (x1)
  - Console, ref V01A02 (x1)
- Quickstart Guide (x1)
- Screw M5 (x4) for fixing the power supply box if needed
- Plastic bag with a cable support and 1 screw, to fix on the power supply box
- Cleaning swab (x20)
- Disinfectant wipes (x100)

\* Applied parts



The forehead rest cover is applied to improve patient comfort.

### b. Optional accessories

- Printer
- Printer paper (x5)

### c. Detachable parts

- Power cable 2 m (x1), Europe type
- Power cable 2 m (x1), US type



Vision-R™ 800 is entirely compatible with chart systems approved and connected by Essilor Instruments.

### **III. GENERAL DESCRIPTION**



## 1. Intended use

### a. Intended purpose

Vision-R™800 (V01) is an automated phoropter that enables you to perform a refraction test. Its function is to determine optical correction (or compensation), thereby providing examinees with optimal vision. This device performs a subjective refraction.

This part of the eye examination is commonly referred to as subjective refraction, because it refers to the patient's responses. In the majority of cases it is performed using preliminary data which may come from:

- The old correction performed using the lensmeter,
- From a measurement of the objective refraction using an auto-refractometer, an aberrometer or a skiascope/retinoscope,
- The old correction archived in a patient file.



Since this is a so-called “automatic” head, its integration into the examination environment also includes the control of the test projection systems from the same control panel.

The patient's subjective refraction is made possible by inserting an optical correction or a diopter compensation and/or filters in front of the patient's eyes.

The measurements can be taken under monocular or binocular vision conditions and subsequently allow for a binocular vision examination to be performed.

The instrument allows the user to carry out continuous variations of optical characteristics (sphere, cylinder, axis and prism).



The intended part of the body applied to the device are: cheeks and front skin are in contact with the device.  
Skin in the contact with the device must be in healthy condition without wounds, irritation or inflammation.



Operating principle: basic operating cycle is: patient installation / patient's eyes centering / refraction protocol selection & launch / refraction result recovery (data export, printing or manual recording) / removal from patient.

### b. Indications for use

The instrument allows the user to control the patient's visual acuity. The instrument allows the user to carry out continuous variations of optical characteristics (sphere, cylinder, axis and prism).

The device must be installed in a refraction environment according to environmental conditions written in this document.

### c. Expected clinical benefit

#### Confidentiality of patient data

The instrument is a system that can save, store and share relative information with the patient such as refraction measurements, name or photo. It is the device user's responsibility to comply with patient data confidentiality regulations, applicable on their site.

### d. Intended population

Any adult or child with pupillary distance from 49mm to 80mm.

### e. Intended users

This device is intended for eye care professionals use only.

## 2. Device description

The main components that make up the Vision-R unit™ 800 are:

- A refraction head
- A console
- A power supply box

## a. Refraction head - (Ref. V01012)

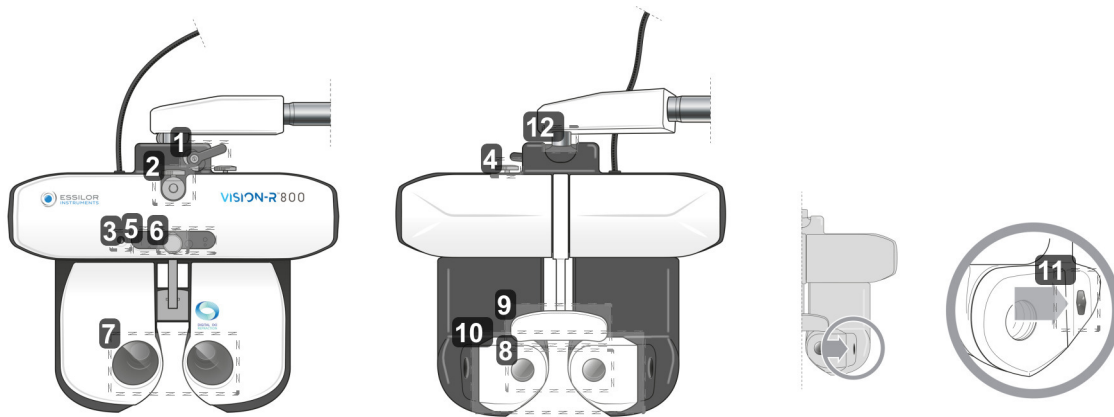

### 1. Tilt blocking lever

Used to adjust the tilt angle (near vision position) and block it.

### 2. Near vision test support rod hook

Used to position the near vision test chart support rod.

### 3. Near vision camera

### 4. Horizontal adjustment knob

Used to adjust the horizontality of the refraction head.

### 5. LED panel

Used for:

- Adjust the horizontality of the head and to illuminate the near-vision card.
- Call up the tests display on the screen.

### 6. Forehead rest adjustment knob

Used to adjust the Vertex distance by advancing or moving back the forehead rest.

### 7. User-side observation windows

Patient eyes observation side.

### 8. Patient side observation windows (SCV module)

Patient side: front area where the patient is positioned and through which he or she looks during the eye test.

### 9. Forehead rest cover\* and forehead rest

Area on which the patient's forehead must rest during the test.

\*Applied part.

### 10. Movable face shield

Area which may be in contact with the patient's cheeks.

Applied part.

### 11. Measurement cameras for Vertex distance

Used to measure the Vertex distance of the patient and to light up their eyes if necessary during the pupillary distance adjustment.

### 12. Rotation axis

360° rotation movement, during the handling of the instrument.

## b. Console - (Ref. V01KB1)

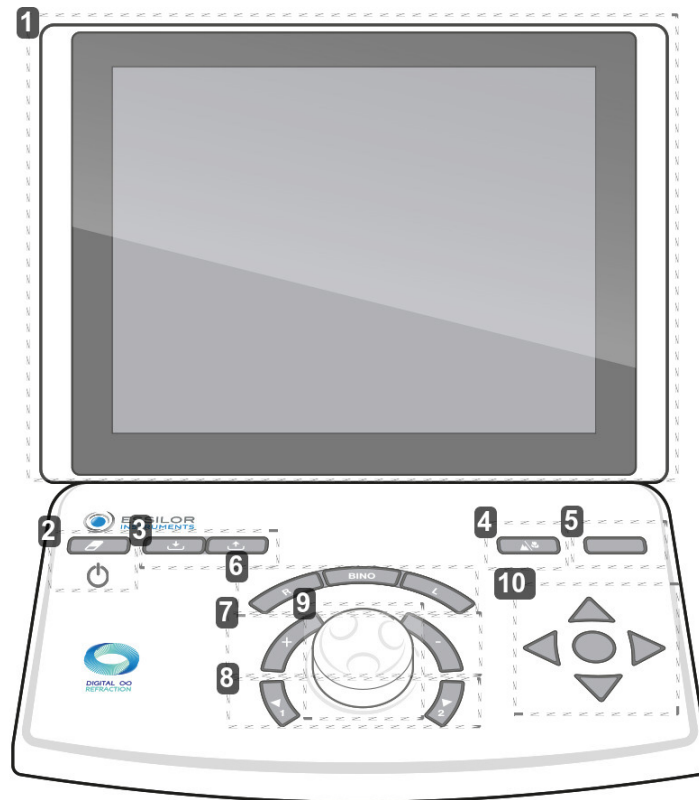

### 1. Touch screen

### 2. Touch [Clear]



Used for:

- Resetting the current session (quick press).
- Turning the instrument on or off (long press).

### 3. Keys [Import/export]

Used for importing  and exporting  the patient's refraction data.

### 4. Touch [Far vision/Near vision]

Used for changing to far-vision mode  or near-vision mode .

### 5. Touch [Bluetouch]

Used for comparing different refraction measurements and rendering the data.

### 6. Buttons [R/BINO/L]

Used for selecting the vision condition:

- Monocular right eye (R) by de-selecting and blocking out the left eye.
- Monocular left eye (L) by de-selecting and blocking out the right eye.
- Binocular (Bino)

### 7. Keys [+/-]

Used for increasing or decreasing the power values.

- Key "+": allows you to increment the positive power values.
- Key "-": allows you to increment the negative power values.

### 8. Keys [Position 1/Position 2]

Used for:

- Navigating through the list of variation steps of the selected optical setting
- Introducing one of the two positions of the cross cylinder while performing the cross-cylinder test

### 9. Central button

Used for:

- Modifying (+), the power values via rotation of the central button
- Navigating through the controlled settings (e.g. S, C, A) by pressing the central button

### 10. Acuity navigation buttons

Used for:

- Navigating through the acuity charts (changing the size of the letters, charts, lines or columns) and saving the answers.
- Navigating through the answers of the dissociated tests
- Confirming the answers of the dissociated tests with the middle button



There are two USB ports located on the side of the console.



## c. Power supply box - (Ref. V01PS1)

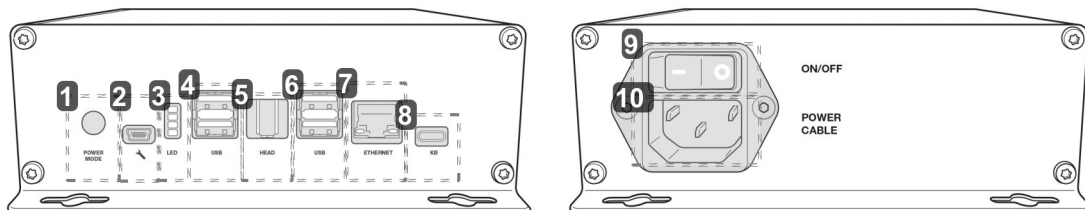

#### 1. Start-up mode

- Position 1: turning on the refraction head by pressing on On/Off with the console.
- Position 2: turning on the phoropter head using the ON/OFF switch on the power supply box.

#### 2. Service technician socket

#### 3. Information indicator lights

#### 4. USB port

#### 5. Refraction head connection port

Used for the connection to the phoropter head.

#### 6. USB port

#### 7. Ethernet port

#### 8. Console connection port

Used for the connection to the console

#### 9. On/off switch

Network isolation switch.

#### 10. Power cable socket

## d. Test presentation screen

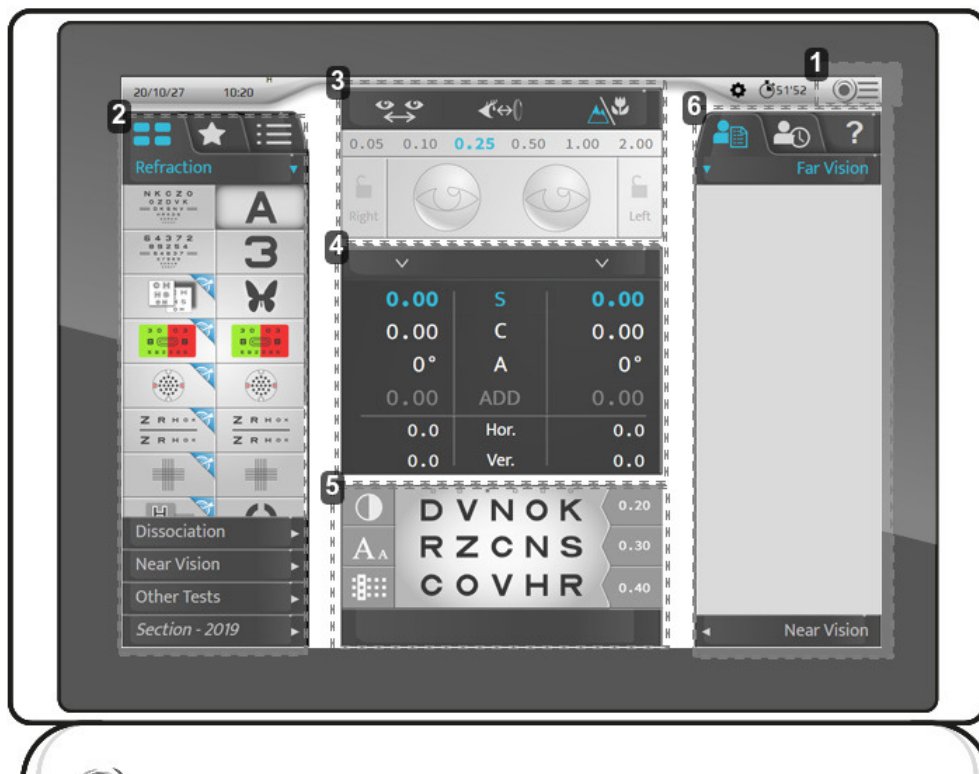

### 1. Access to the main menu

Permits access to the instrument configuration screens.

### 2. Optotypes, tests

Used to display the various categories of types and tests (manual or automatic), associated optotypes and programs.

### 3. Configuration for the setup of the patient

Used to check and manage:

- The inter-pupillary distance.
- The Vertex distance.
- The far vision or near vision mode.
- To apply filters or masks to the eyes of the patient.
- To modify the steps of the current setting.
- To lock an eye.

### 4. Controlled parameters

Used to select and modify the values of the presented optical settings.

### 5. Visualization of the current test.

Used to visualize, personalize the test in progress and to include the answers of the patient.

### 6. Management of the patient data and user help display

Allows you to:

- Manage the patient data.
- Display and call up memorized data.
- Display the contextual assistance.

## **IV. INSTALLATION / CONNECTION**





This instrument must be installed by a specialized technician. To install the instrument or to change its connection, please contact your Essilor dealer.

Respect the precautions below:

- Do not install the instrument in a location:
  - where dust or dirt accumulates,
  - directly exposed to the light rays,
  - oxygen rich,
  - displaying extreme temperatures and humidity levels,
  - likely to undergo strong oscillations or sudden shocks.
- Do not use the instrument with flammable anaesthetics or in conjunction with flammable agents.
- The instrument should not fall; that would likely cause malfunctions. If it does fall, the instrument could also crush your body or feet.
- Do not place your hand between the mounting arm and the instrument. You could get your hand wedged.
- To avoid any risk of injury, be careful when installing or using the near-vision support bracket.

## 1. Installation of the device



Position the mounting arm to the phoropter head and attach it using the fixing screw (6-sided key).

> To prevent the phoropter head from falling, fasten it with the screw located below the arm of the head.

> Despite the holes, the power supply box does not need to be fixed.

> But, if you want to fix the power supply horizontally you need to use 4 M5 screws.

## 2. Turning ON/OFF

### a. Turn on the instrument

- 1 During the first powering up of the instrument, press the ON/OFF switch on the power supply unit.



For future instrument use, the power unit can stay turned on.

In this case, go directly to step 2.

- 2 Press on the ON/OFF switch [Clear] on the console.



> The system is initialized (refraction head and console).

- 3 Then, press the ON/OFF switch on the chart screen.

> The instrument is ready to be used.

## b. Turn off the instrument

- 1 Press and hold the ON/OFF switch [Clear] on the console.
  - > The message [Clear all dated] is displayed.
- 2 Hold the switch down until the console turns off.
  - > The console turns off.

## 3. Connection to other instruments

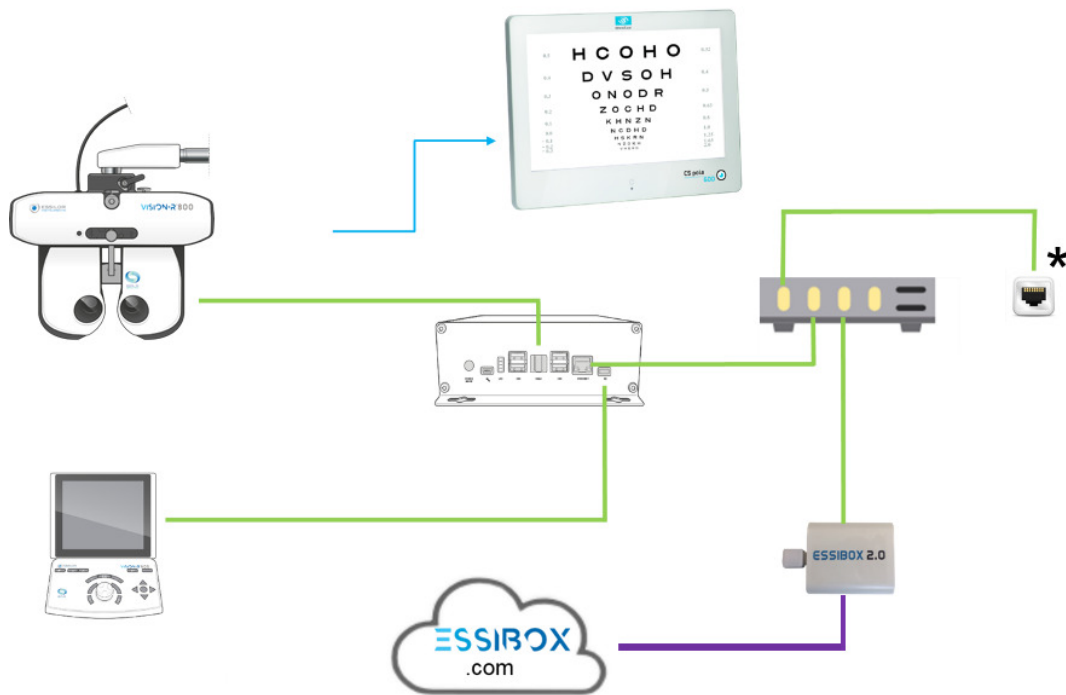

### With:

- — Cable connection
- — Infrared connection
- — Web connection
- \* Wall plug RJ-45

## **V. ADJUSTMENTS BEFORE THE EXAMINATION**





Operating principle: basic operating cycle is: patient installation / patient's eyes centering / refraction protocol selection & launch / refraction result recovery (data export, printing or manual recording) /removal from patient.

## 1. Configure the instrument



### a. Set the instrument data to zero

At the end of each examination, it is possible to set the instrument data to zero. The expert can then start a new session with a new patient.

Restoring the instrument data can be carried out:

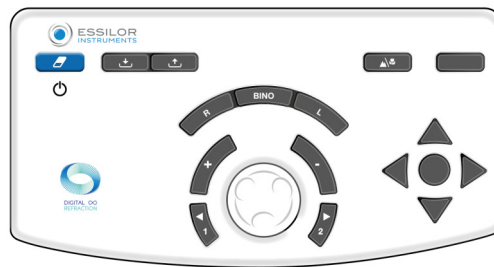
- On the console keyboard, by quickly pressing on the key [Clear].



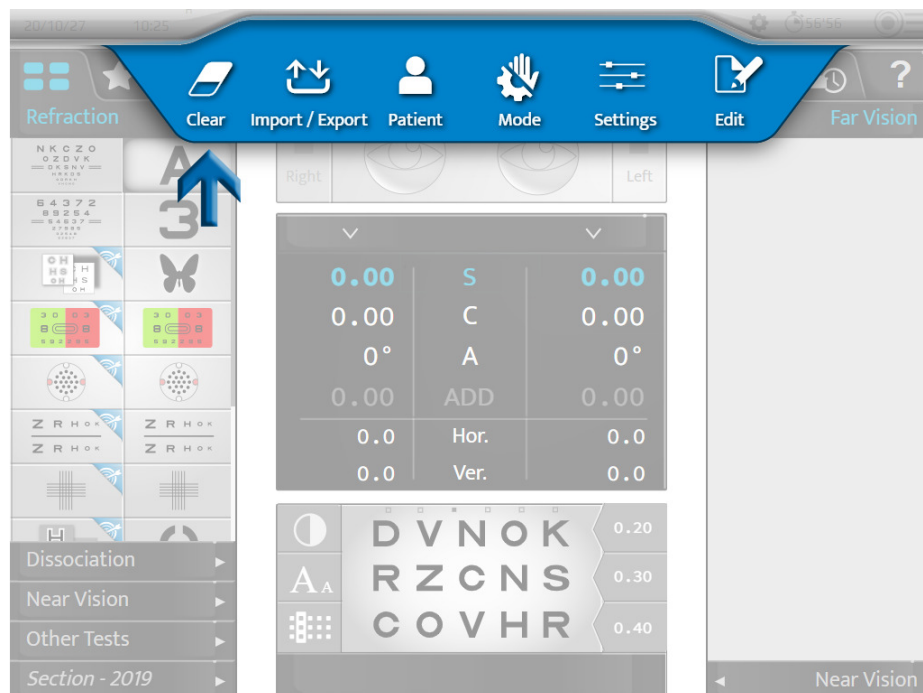

- On the touch screen, by pressing on  > .



The restoring of the patient data does not cause the instrument to turn off.



## b. Pass from the manual mode to the automatic mode

Changing from manual mode to automatic mode can be carried out on the touch screen by pressing on:

-  or,
-  (displayed by default).





Once the mode is chosen, the display of the upper strip changes:



-  for manual mode.
-  for automatic mode.

## c. Import and export data

The importing and exporting of the instrument data can be carried out:

- On the console keyboard, by pressing on the [Import]  or [Export]  keys.



- On the touch screen, by pressing on  > .

Once import or export has been selected, the corresponding windows open:

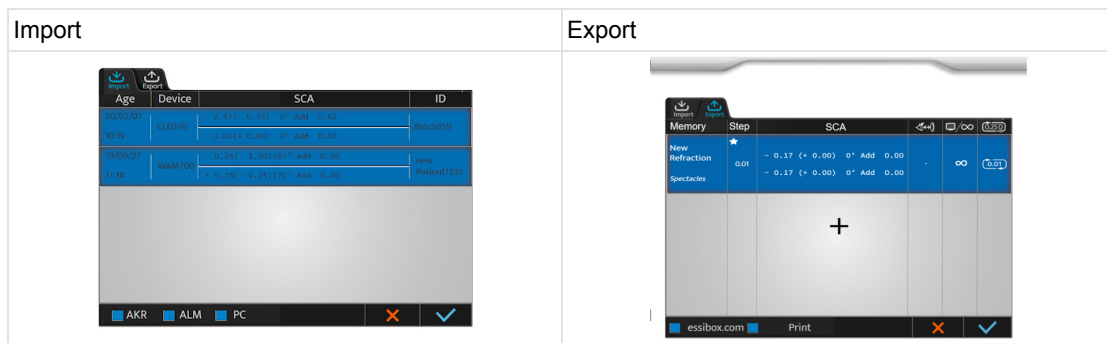



It is possible to choose which data should be imported:

- AKR (Auto-kerato-refractometer)
- ALM (Lensmeter)
- PC (Computer)

The data is saved automatically in the corresponding memory.

Press:

-  to confirm the importing or the export of the data.
-  to cancel the importing or the export of the data.



You can select several types of products.

## 2. Setting up the patient

Before each refraction examination, perform various adjustments.



The adjustment below can be carried out via the touch screen or the keyboard on the console.

It is advisable to adjust:

- The horizontality of the refraction head with the knob located on the top of the refraction head,
- Monocular or Binocular pupillary distances ,
- The forehead position with the knob located on the front of the refraction head.

It is also advisable to check the Vertex distance .



Correct installation must:

- Allow the patient to have a comfortable posture which guarantees his or her stability throughout the examination.
- Prevent the patient from being in contact with the optics (eyelash rubbing for example).

### a. Adjusting the horizontality of the refraction head

Horizontality adjustments are performed manually by using the knob located on the top of the refraction head.

In pupillary distance mode , the LEDs placed on the front of the head provide an indication of its horizontality. If:

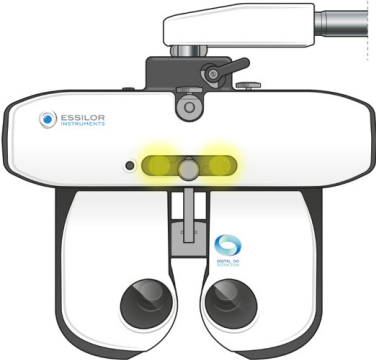
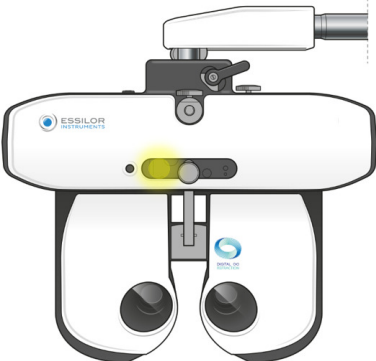
|   |  |
|---|--|
| <ul style="list-style-type: none"> <li>• when both LEDs are lit up, the adjustment is correct.</li> </ul>   |  |
| <ul style="list-style-type: none"> <li>• when only one of the LEDs flickers or if a LED is not lit up, it is necessary to adjust the horizontality by using the adjustment knob.</li> </ul> |  |

### b. Adjusting the inter-pupillary distances

Before adjusting the distances, position the refraction head in front of the patient's eyes and ensure that the patient is comfortably seated. The chart screen must be in the middle of the patient's field of vision.

The adjustment of the inter-pupillary distances is carried out via the console touch screen by pressing on .

> The reticles are placed in front of the patient's eyes and the right and left distance values are displayed.



It is possible to regulate the pupillary distances in far vision and near vision.

The value:

- Of an eye corresponds to monocular half PD,
- Of the two eyes corresponds to the total binocular distance.



By default, the step is 1 mm for the total distance.

The adjustment of the inter-pupillary distances can be carried out on the console:

- By turning the central button clockwise or counterclockwise.



- By pressing on the keys [+/-].

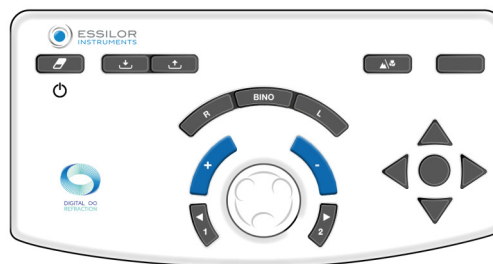

### c. Adjusting the forehead rest

The forehead rest adjustment is performed manually thanks to the knob located on the front of the head of refraction.



Adjustment of the forehead rest affects the Vertex distance. So, it is better to place the refraction head as close as possible to the patient's eyes.

Check the Vertex distance

The inspection of the Vertex distance is performed on the touch screen by pressing on .

> Images of the patient's right eye and the left eye appear at the top of the console screen.

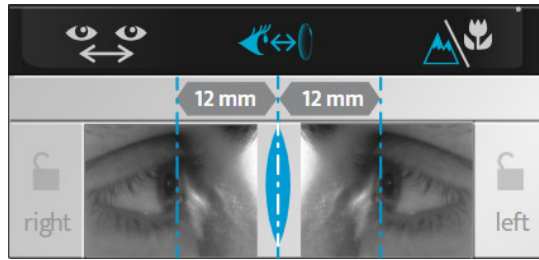

> Adjust the position of the vertical lines to match the corneal apex of each eye using the central button or the incrementation keys (+/-) on the console keyboard.





The Vertex distance can be modified by adjusting the forehead rest using the knob located on the front of the refraction head.

#### **d. Going from far-vision mode to near-vision mode**

Going from far-vision mode to near-vision mode can be performed:

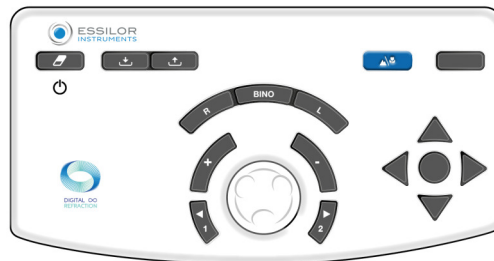

- On the console keyboard, by pressing on the key [NV/FV].

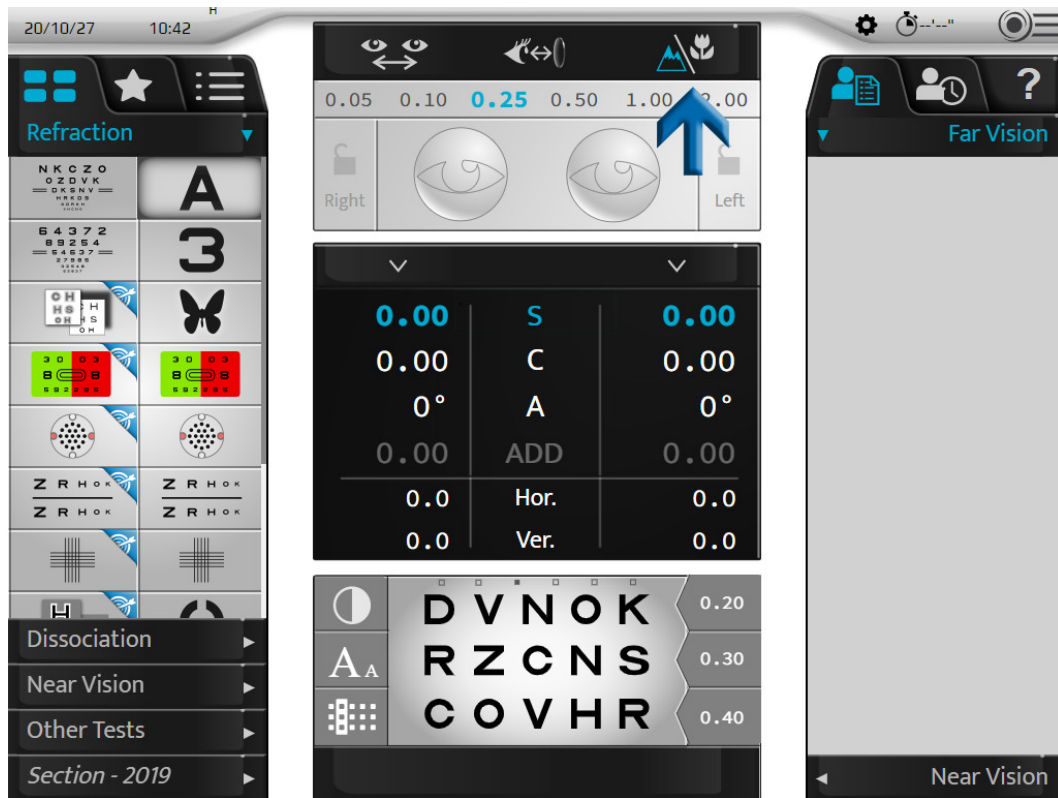

- On the touch screen, by pressing on .



The icon corresponding to the selected mode is displayed in blue on the interface:

-  for far-vision mode.
-  for near-vision mode.



Switching to near vision mode modifies, the inter-pupillary distances, the convergence of the refraction head and the lighting up of the LEDs.

## **VI. BASIC FUNCTIONS FOR PERFORMING A REFRACTION EXAMINATION**

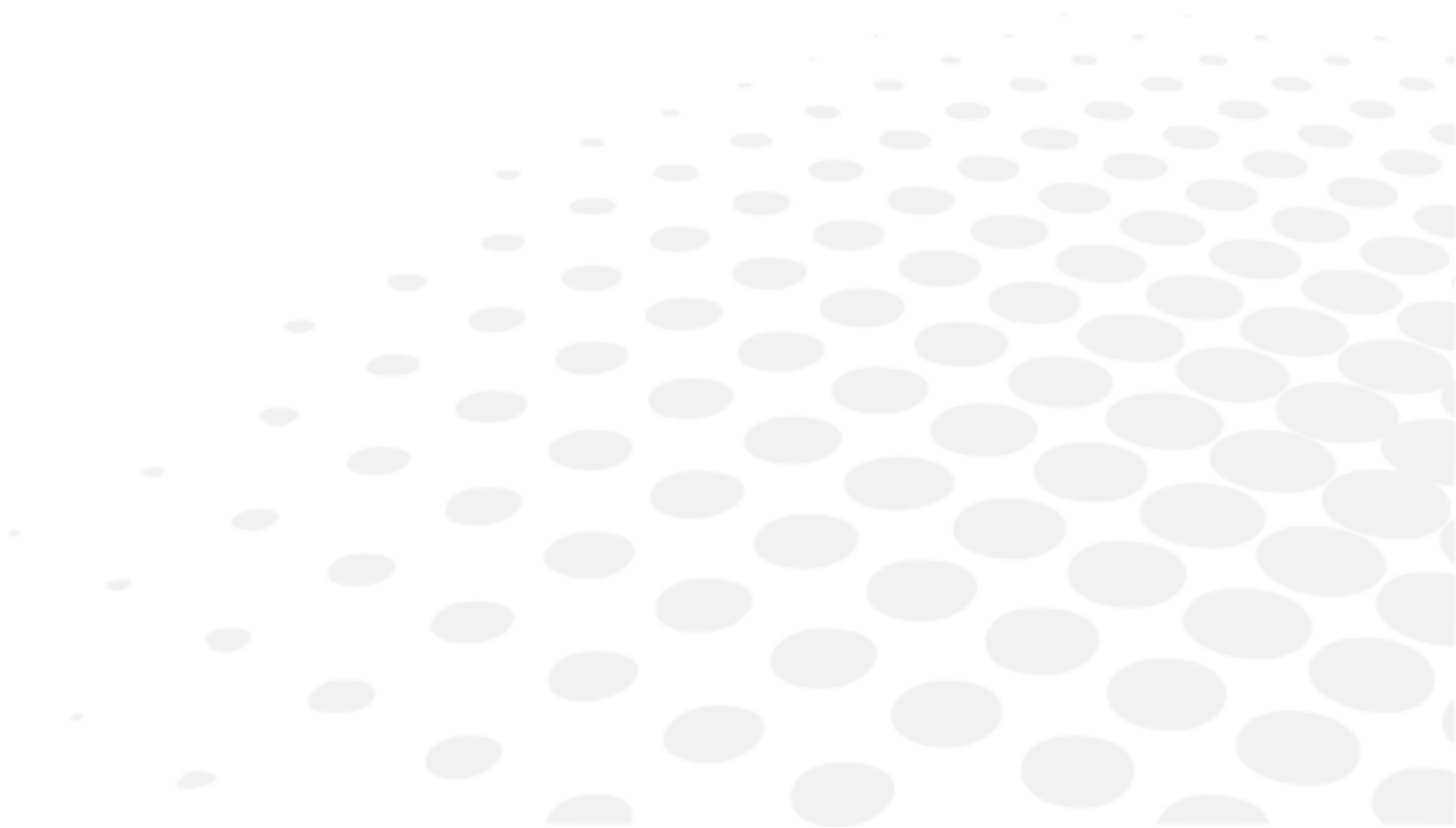

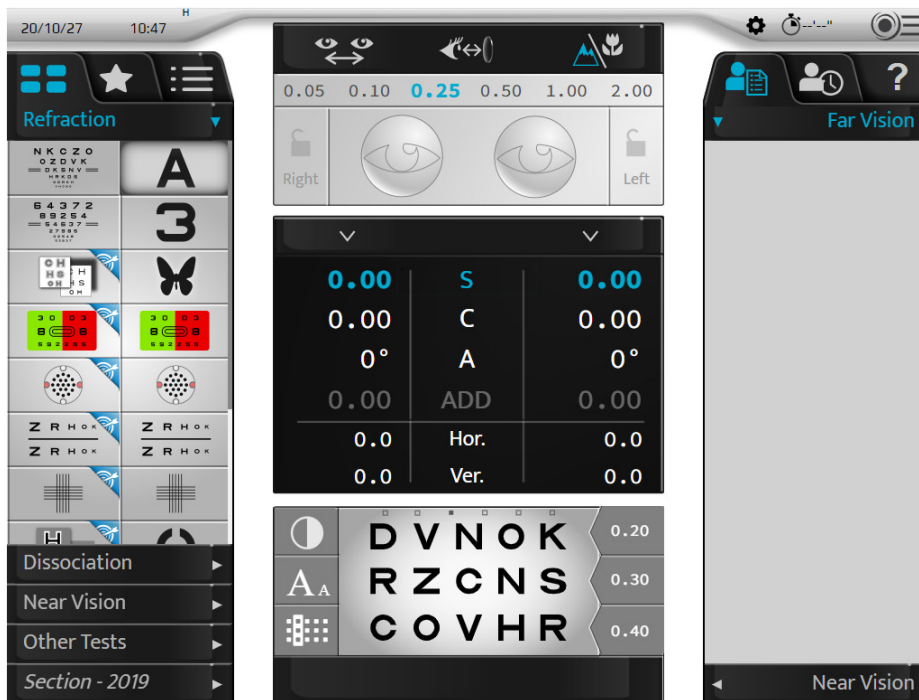

## 1. Choose a test

The choice of the tests is done on the left part of the main screen.



Several test formats are available. Press:

-  to access the list of tests available,
-  to access the pre-selected favorite tests,
-  to access the standard or personalized test programs.



### a. Select a test

Press on the icon of the test that you want to start. A visualization of the test is displayed at the bottom of the main screen.



When you select a test, the controlled settings as well as the applied filters are automatically modified.

If you wish to deactivate this function, go into manual mode on the touch screen by pressing on:

-  > , or,
-  (displayed by default).

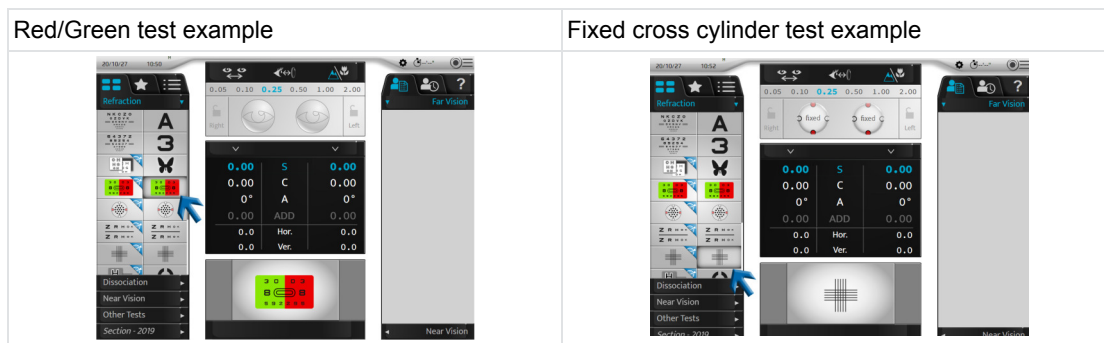

## b. Start an existing test program

- 1 Press on the icon of the test program .



- > The list of available test programs are displayed depending of the lensmeter, autorefractometer memories and/or age of the patient, one program is suggest.

This one appears in bold.



The Vision-R<sup>TM</sup>800 has the ability to recommend the best program to perform on the patient. This recommendation is calculated by the information imported into the phoropter.

For the most completed recommendation the ECP will need to enter objective measurement, lensmeter and age of the patient. Then, the recommended program will appear in bold.



- 2 Select the program that you wish to use.
  - > The test program is displayed and the first test is set up automatically.

You can:

- Follow the program's progression on the progression bar.
- Leave the program at any time by clicking on [STOP].
- Go to the following test by pressing on:
  - the associated icon,
  - [NEXT] in the case of smart tests.



If you wish to select a test outside the program in progress, press on the test list or favorite tests .

It is possible to return to the running program by pressing on the corresponding icon.

## 2. Checking the optical module

### a. Changing the checked eye

Selecting the examined eye can be done:

- On the touch screen by selecting:
  - the power of the right eye or the left eye, for the separate inspection of each eye or,
  - on the settings (S, C, A, ADD, Hor., Ver.) for the simultaneous inspection of both eyes.

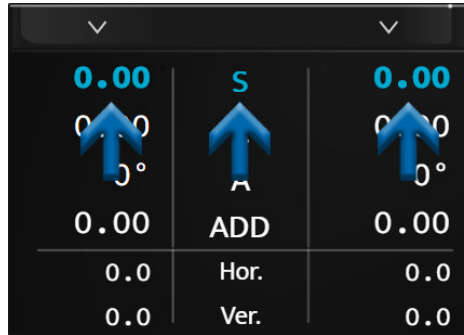

- On the console keyboard, by pressing on the keys [R, BINO, L].



### b. Change the controlled settings

Moving from one controlled setting (S, C, A, ADD, Hor., Ver.) to another can be carried out:

- On the touch screen, by pressing on the setting that you wish to check (on the value of the right eye or the left eye or on the setting).

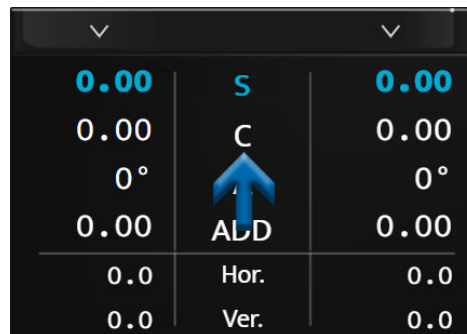

- On the console keyboard, by pressing on the central button.

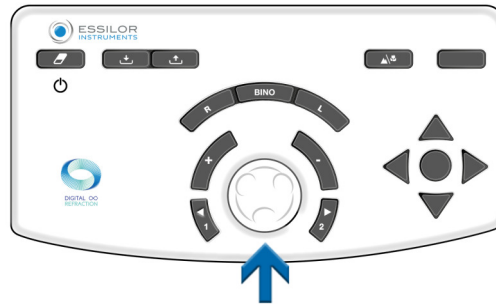

Depending on the instrument's status, the operation can be carried out in various ways:

| Far vision  | Near vision | Prism |      |      |   |      |    |   |    |      |     |      |     |      |     |     |      |     |   |      |   |      |      |   |      |    |   |    |      |     |      |     |      |     |     |      |     |   |      |   |      |      |   |      |    |   |    |      |     |      |     |      |     |     |      |     |
|---|-------------|-------|------|------|---|------|----|---|----|------|-----|------|-----|------|-----|-----|------|-----|---|------|---|------|------|---|------|----|---|----|------|-----|------|-----|------|-----|-----|------|-----|---|------|---|------|------|---|------|----|---|----|------|-----|------|-----|------|-----|-----|------|-----|
| <table border="1"> <tr><td>0.00</td><td>S</td><td>0.00</td></tr> <tr><td>0.00</td><td>C</td><td>0.00</td></tr> <tr><td>0°</td><td>A</td><td>0°</td></tr> <tr><td>0.00</td><td>ADD</td><td>0.00</td></tr> <tr><td>0.0</td><td>Hor.</td><td>0.0</td></tr> <tr><td>0.0</td><td>Ver.</td><td>0.0</td></tr> </table> | 0.00        | S     | 0.00 | 0.00 | C | 0.00 | 0° | A | 0° | 0.00 | ADD | 0.00 | 0.0 | Hor. | 0.0 | 0.0 | Ver. | 0.0 | <table border="1"> <tr><td>0.00</td><td>S</td><td>0.00</td></tr> <tr><td>0.00</td><td>C</td><td>0.00</td></tr> <tr><td>0°</td><td>A</td><td>0°</td></tr> <tr><td>0.00</td><td>ADD</td><td>0.00</td></tr> <tr><td>0.0</td><td>Hor.</td><td>0.0</td></tr> <tr><td>0.0</td><td>Ver.</td><td>0.0</td></tr> </table> | 0.00 | S | 0.00 | 0.00 | C | 0.00 | 0° | A | 0° | 0.00 | ADD | 0.00 | 0.0 | Hor. | 0.0 | 0.0 | Ver. | 0.0 | <table border="1"> <tr><td>0.00</td><td>S</td><td>0.00</td></tr> <tr><td>0.00</td><td>C</td><td>0.00</td></tr> <tr><td>0°</td><td>A</td><td>0°</td></tr> <tr><td>0.00</td><td>ADD</td><td>0.00</td></tr> <tr><td>0.0</td><td>Hor.</td><td>0.0</td></tr> <tr><td>0.0</td><td>Ver.</td><td>0.0</td></tr> </table> | 0.00 | S | 0.00 | 0.00 | C | 0.00 | 0° | A | 0° | 0.00 | ADD | 0.00 | 0.0 | Hor. | 0.0 | 0.0 | Ver. | 0.0 |
| 0.00  | S           | 0.00  |      |      |   |      |    |   |    |      |     |      |     |      |     |     |      |     |   |      |   |      |      |   |      |    |   |    |      |     |      |     |      |     |     |      |     |   |      |   |      |      |   |      |    |   |    |      |     |      |     |      |     |     |      |     |
| 0.00  | C           | 0.00  |      |      |   |      |    |   |    |      |     |      |     |      |     |     |      |     |   |      |   |      |      |   |      |    |   |    |      |     |      |     |      |     |     |      |     |   |      |   |      |      |   |      |    |   |    |      |     |      |     |      |     |     |      |     |
| 0°  | A           | 0°    |      |      |   |      |    |   |    |      |     |      |     |      |     |     |      |     |   |      |   |      |      |   |      |    |   |    |      |     |      |     |      |     |     |      |     |   |      |   |      |      |   |      |    |   |    |      |     |      |     |      |     |     |      |     |
| 0.00  | ADD         | 0.00  |      |      |   |      |    |   |    |      |     |      |     |      |     |     |      |     |   |      |   |      |      |   |      |    |   |    |      |     |      |     |      |     |     |      |     |   |      |   |      |      |   |      |    |   |    |      |     |      |     |      |     |     |      |     |
| 0.0   | Hor.        | 0.0   |      |      |   |      |    |   |    |      |     |      |     |      |     |     |      |     |   |      |   |      |      |   |      |    |   |    |      |     |      |     |      |     |     |      |     |   |      |   |      |      |   |      |    |   |    |      |     |      |     |      |     |     |      |     |
| 0.0   | Ver.        | 0.0   |      |      |   |      |    |   |    |      |     |      |     |      |     |     |      |     |   |      |   |      |      |   |      |    |   |    |      |     |      |     |      |     |     |      |     |   |      |   |      |      |   |      |    |   |    |      |     |      |     |      |     |     |      |     |
| 0.00  | S           | 0.00  |      |      |   |      |    |   |    |      |     |      |     |      |     |     |      |     |   |      |   |      |      |   |      |    |   |    |      |     |      |     |      |     |     |      |     |   |      |   |      |      |   |      |    |   |    |      |     |      |     |      |     |     |      |     |
| 0.00  | C           | 0.00  |      |      |   |      |    |   |    |      |     |      |     |      |     |     |      |     |   |      |   |      |      |   |      |    |   |    |      |     |      |     |      |     |     |      |     |   |      |   |      |      |   |      |    |   |    |      |     |      |     |      |     |     |      |     |
| 0°  | A           | 0°    |      |      |   |      |    |   |    |      |     |      |     |      |     |     |      |     |   |      |   |      |      |   |      |    |   |    |      |     |      |     |      |     |     |      |     |   |      |   |      |      |   |      |    |   |    |      |     |      |     |      |     |     |      |     |
| 0.00  | ADD         | 0.00  |      |      |   |      |    |   |    |      |     |      |     |      |     |     |      |     |   |      |   |      |      |   |      |    |   |    |      |     |      |     |      |     |     |      |     |   |      |   |      |      |   |      |    |   |    |      |     |      |     |      |     |     |      |     |
| 0.0   | Hor.        | 0.0   |      |      |   |      |    |   |    |      |     |      |     |      |     |     |      |     |   |      |   |      |      |   |      |    |   |    |      |     |      |     |      |     |     |      |     |   |      |   |      |      |   |      |    |   |    |      |     |      |     |      |     |     |      |     |
| 0.0   | Ver.        | 0.0   |      |      |   |      |    |   |    |      |     |      |     |      |     |     |      |     |   |      |   |      |      |   |      |    |   |    |      |     |      |     |      |     |     |      |     |   |      |   |      |      |   |      |    |   |    |      |     |      |     |      |     |     |      |     |
| 0.00  | S           | 0.00  |      |      |   |      |    |   |    |      |     |      |     |      |     |     |      |     |   |      |   |      |      |   |      |    |   |    |      |     |      |     |      |     |     |      |     |   |      |   |      |      |   |      |    |   |    |      |     |      |     |      |     |     |      |     |
| 0.00  | C           | 0.00  |      |      |   |      |    |   |    |      |     |      |     |      |     |     |      |     |   |      |   |      |      |   |      |    |   |    |      |     |      |     |      |     |     |      |     |   |      |   |      |      |   |      |    |   |    |      |     |      |     |      |     |     |      |     |
| 0°  | A           | 0°    |      |      |   |      |    |   |    |      |     |      |     |      |     |     |      |     |   |      |   |      |      |   |      |    |   |    |      |     |      |     |      |     |     |      |     |   |      |   |      |      |   |      |    |   |    |      |     |      |     |      |     |     |      |     |
| 0.00  | ADD         | 0.00  |      |      |   |      |    |   |    |      |     |      |     |      |     |     |      |     |   |      |   |      |      |   |      |    |   |    |      |     |      |     |      |     |     |      |     |   |      |   |      |      |   |      |    |   |    |      |     |      |     |      |     |     |      |     |
| 0.0   | Hor.        | 0.0   |      |      |   |      |    |   |    |      |     |      |     |      |     |     |      |     |   |      |   |      |      |   |      |    |   |    |      |     |      |     |      |     |     |      |     |   |      |   |      |      |   |      |    |   |    |      |     |      |     |      |     |     |      |     |
| 0.0   | Ver.        | 0.0   |      |      |   |      |    |   |    |      |     |      |     |      |     |     |      |     |   |      |   |      |      |   |      |    |   |    |      |     |      |     |      |     |     |      |     |   |      |   |      |      |   |      |    |   |    |      |     |      |     |      |     |     |      |     |

### c. Modify the power and the incrementation steps

#### Modify the power

The modification of the power can be carried out:

- On the touch screen, by pressing a second time on the desired controlled setting.



> In this case, a numeric keypad is displayed. Enter the desired value and confirm ✓.

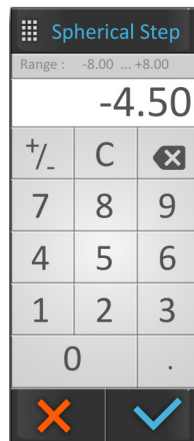

Once input is complete, do not forget to save the initial prescription in the memory of your choice.

- On the console keyboard:
  - by turning the central button clockwise or counterclockwise, or

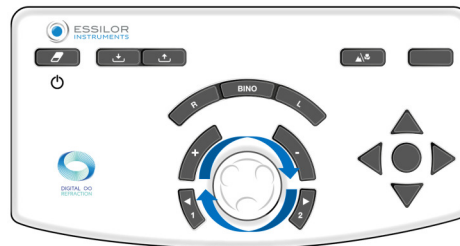

- by pressing on the keys [+/-].

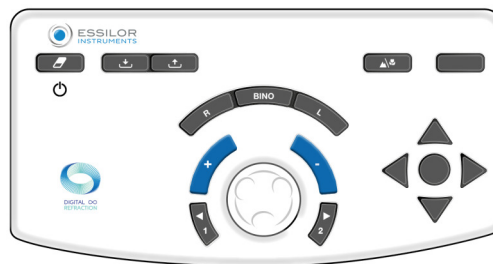

**Example:**

If you wish to modify the sphere (S), it is possible to modify the values of the right eye or the left eye independently, or both at the same time by selecting “S” directly.

**d. Modify the incrementation steps**

Three step variation choices are configurable:

1. Sphere and cylinder variation step
2. Axis variation step
3. Prism variation step

The value is displayed in the upper blue strip and depends on the active setting.

The unit and the step value depend on this setting. The modification of the incrementation step can be carried out:

- On the touch screen, by selecting the desired step value.

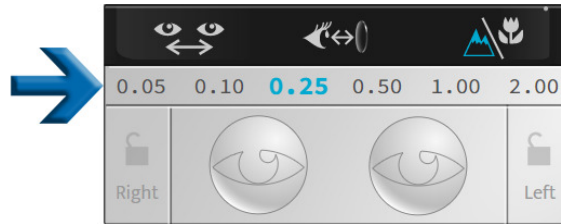

- On the console keyboard, by pressing on the keys [1 and 2].



According to the controlled settings, the values are not the same:

- The sphere (S), the cylinder (C) and additions (ADD) are displayed in diopters and are adjustable to 0.05, 0.10, 0.25, 0.50, 1.00 or 2.00D.  
> **By default, the step is 0.25D.**
- The axis (A) are displayed in degrees and are adjustable to 1°, 5°, 10°, 20°, 45° or 90°.  
> **By default, the step is 5°.**
- The prisms (Hor. and Vert.) are displayed in prismatic diopters and are adjustable to 0.1, 0.5, 1.0, 2.0, 3.0 or 6.0 R.  
> **By default, the step is 1D.**

### e. Value locking function

The value locking function is useful if you wish to lock in different values. To do this, press on the lock icon.

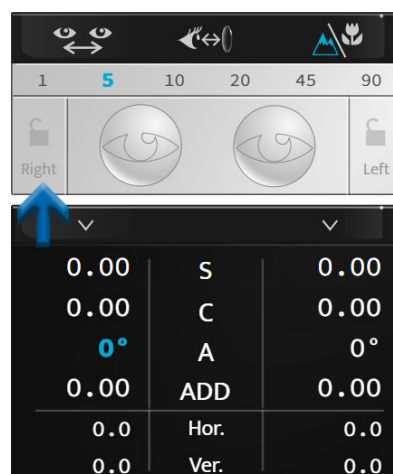



The icon of a closed lock is displayed, the values are grayed and cannot be modified any more.

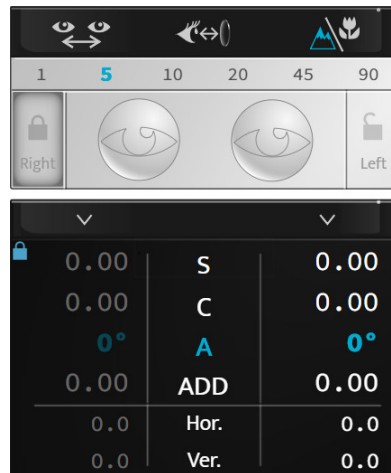

To unlock the values, press on the lock icon again.

### 3. Mask an eye and check the filters

#### a. Check the masks

Press on the eye which you wish to mask.

> The mask is applied automatically in front of the eye of the patient.



The mask can be:

- A black mask.
- A spherical power, in this case a lens of this power is applied in front of the eye of the patient.
  - > The value of this is displayed on the selected eye.



The mask set up is automatic during the automated refraction tests, contrary to the dissociated tests.



If you wish to deactivate this function, go into manual mode on the touch screen by pressing on:

- > or,
- (displayed by default).

#### b. Check and modify the filters

To personalize the filters to be applied in front of the eyes of the patient, press and hold on one of the two eyes.

A window opens:



You can select the different filters:



- Monocular, separate right eye and left eye,
- Binocular with filter couples.



The action is manual. If filters are applied for a test, the adjustment is temporary up to the start of a new session.

The selected filters are displayed in the top part of the window.

Once this is done, press on:

-  to confirm the selection.
-  to cancel.

### c. Modify the type of occlusion

To personalize the type of occlusion to be applied in front of the unchecked eye, press and hold on one of the two eyes.

A window opens:

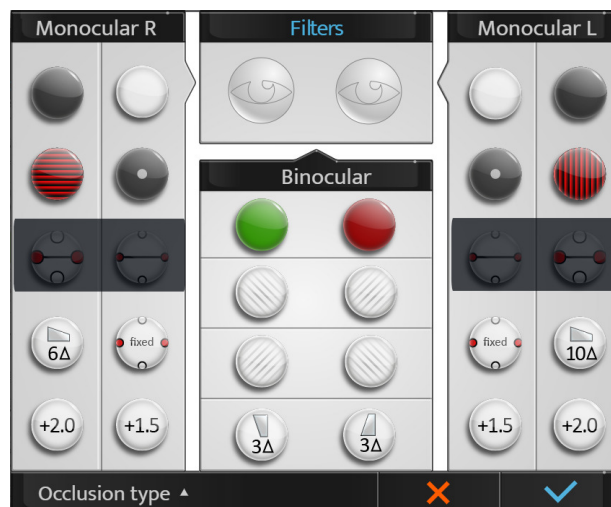



Press on [Occlusion type] and select the desired type of occlusion from the list:



The action is manual. If a type of occlusion is applied, the adjustment is temporary up to the start of a new session.

#### 4. View exported data at the end of the exam

To view exported data press on  > .

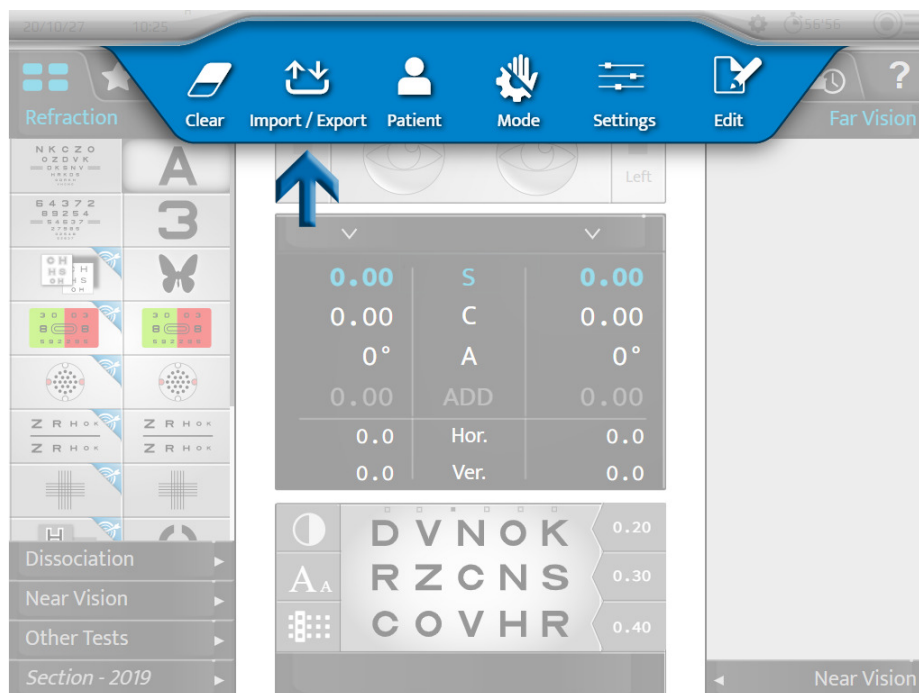

- On the console keyboard, by pressing on the [Export] .



The following page appears:

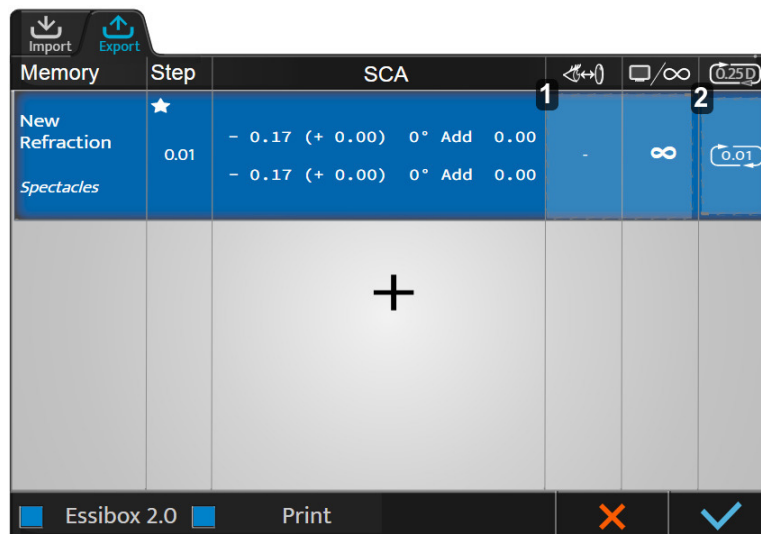

### 1. Zone 1

By clicking on this area, the different settings can be changed again:

- Name
- Source
- Screen Distance
- Vertex distance
- Rounding
- Day vision/night vision

### 2. Zone 2

Rounding values can be viewed and selected by clicking on this area.

Click on  in the [Step] box to define which primary requirement will be exported first and which one will be chosen if the choice of correction needs to be made.



Click on  to access a list of predefined export data types (based on memory information) and select one.



If the Vertex distance has not been measured, it is not indicated for the glasses correction and adjusted to 0 mm for the contact lens correction starting from the reference vertex distance (chosen with the phoropter settings).

To change the values, click on the box in the corresponding column.

The export data configuration page appears. Changes are made as described above.

## 5. Manage the patient data

### a. Add a patient folder

To create a patient folder press on   .

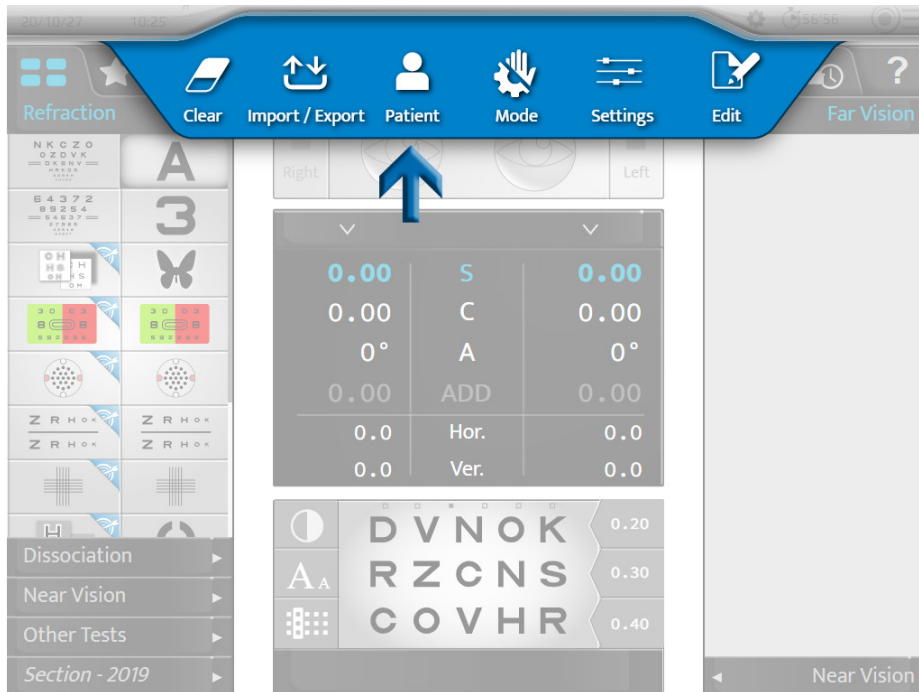

> The patient folder creation page is displayed:

Fill in the required fields:



**Reminders**

- ♂: male
- ♀: female

Once the folder is filled in, press on:

- ✓ to confirm.
- ✗ to cancel.

**6. Access with contextual assistance**

To access with contextual assistance, press on **?**.

The phraseology of the tests as well as actions to be performed on the console are displayed on the right part of the screen.

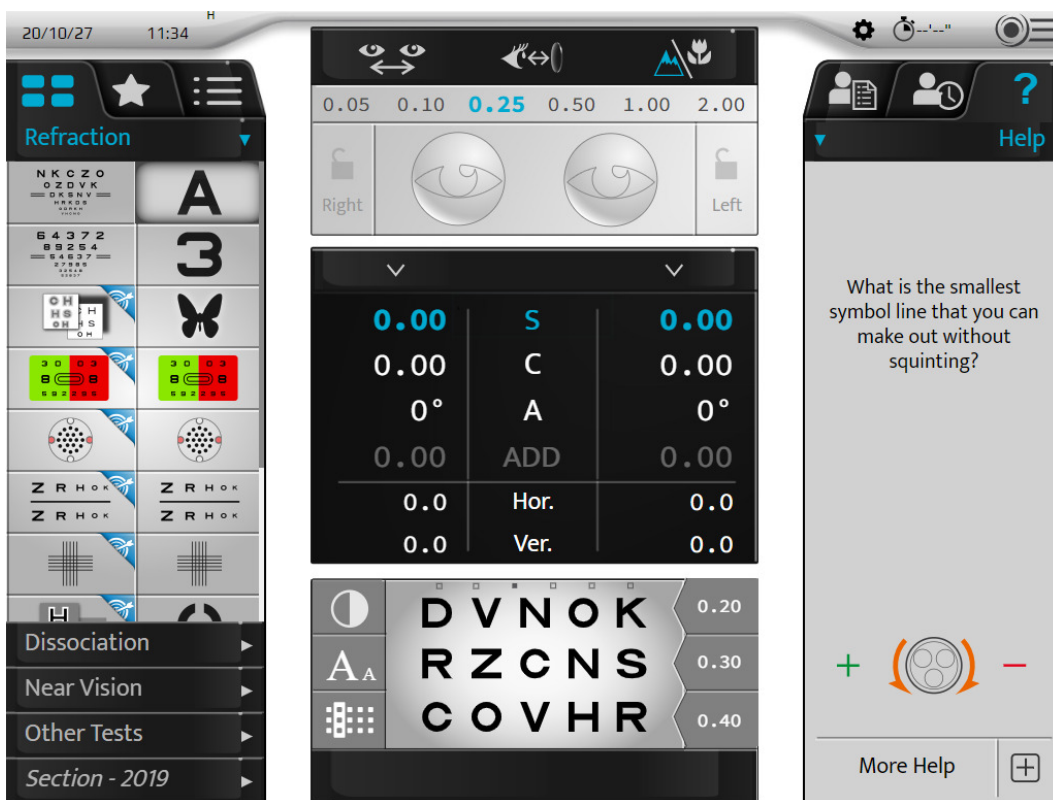

If you wish to display more information on the test, press on [More help] **+**.

An additional help page is displayed:

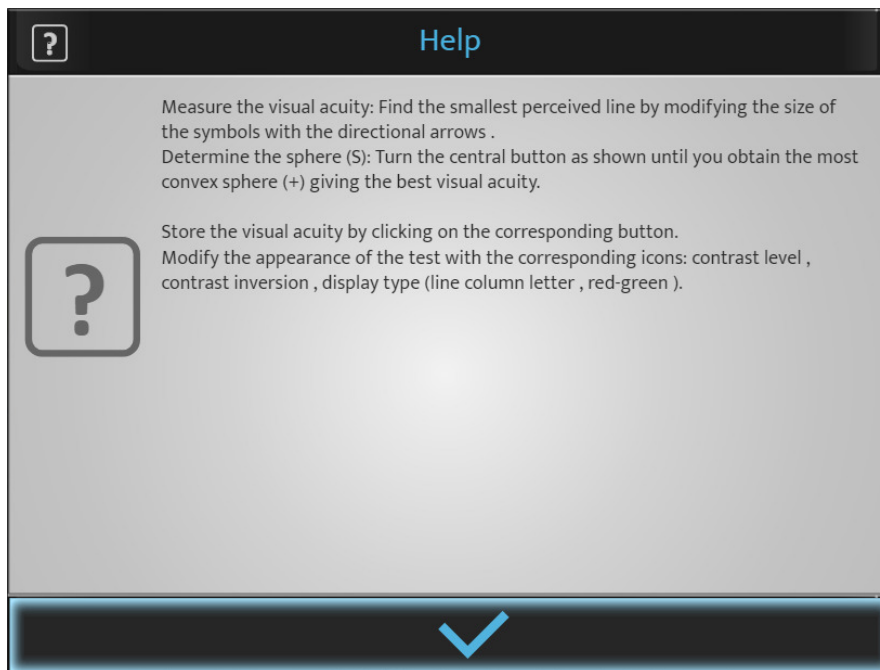

Press on ✓ to close the page.

## **VII. PERFORMANCE OF TESTS DURING A REFRACTION EXAMINATION**

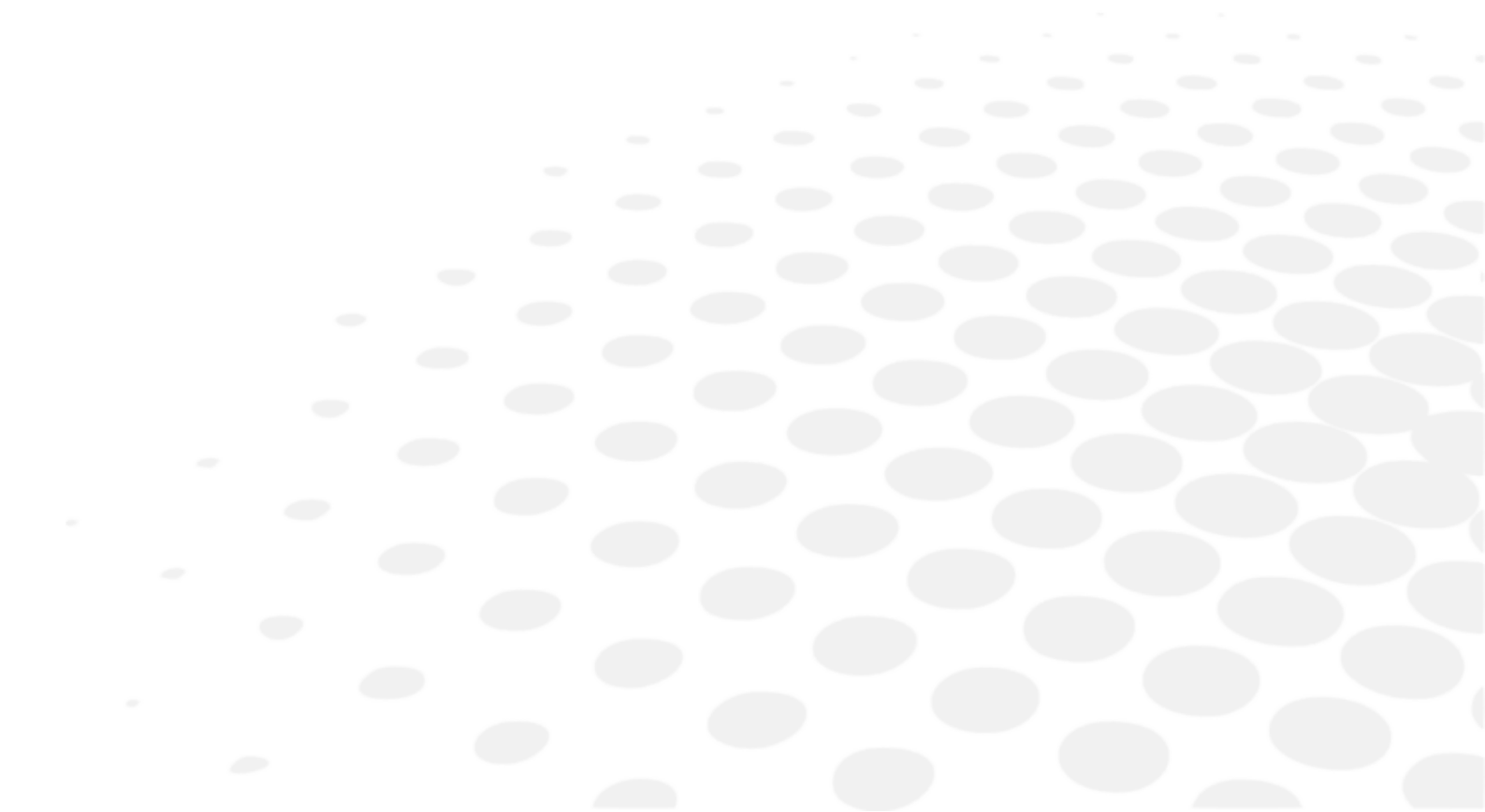

## 1. Patient refraction data input

### a. Objective



Before performing the refraction tests, it is necessary to first enter the data of patient's initial refraction into the instrument.

These data can come from:

1. The previous measured refraction on the glasses of the patient,
2. The objective refraction:
  - o measured with the auto-refractometer or a skiascope/retinoscope,
  - o determined by an aberrometer.
3. The patient folder.

### b. Data importing from Essibox.com

The patient refraction data importing from Essibox.com can be done:

- On the touch screen, by pressing on  > .

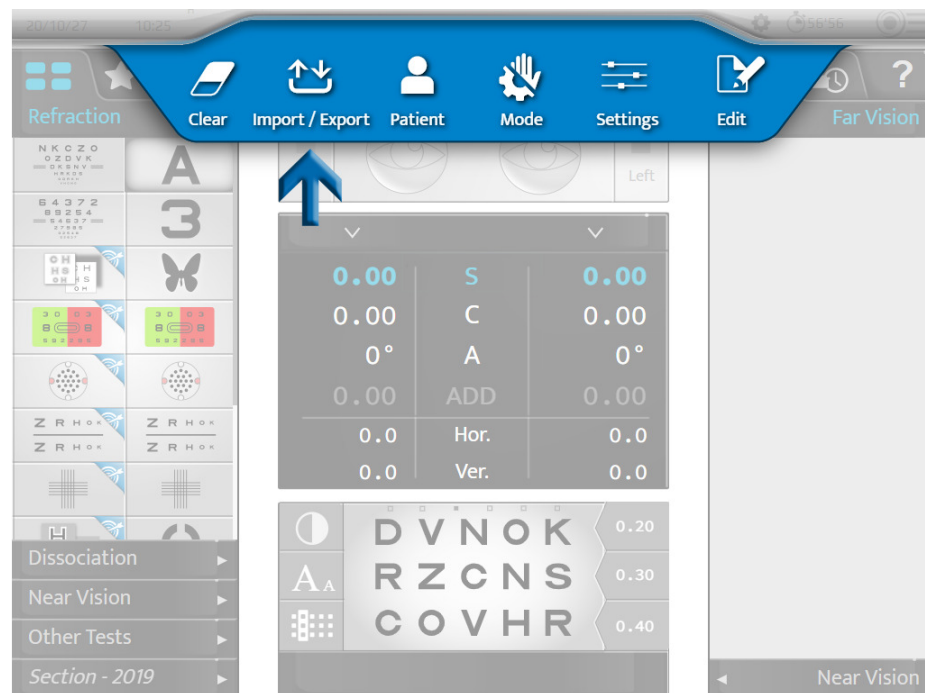

- On the console keyboard, by pressing on the [Import] .

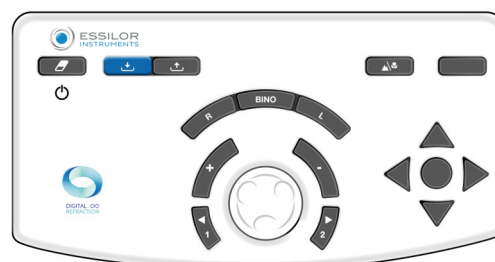

According to imported information and the phoropter settings, the refraction data is automatically placed in one of the memories of the phoropter:

- [Lensmeter]: previous correction
- [Autorefractor]: objective refraction measured with the auto-refractometer or the aberrometer
- [Retinoscopy]: refraction measured by skiascope/retinoscope
- [Patient file]: refraction from the patient folder
- [Subjective night]
- [Auto-kerato-refractometer night]
- [Memory 1]
- [Memory 2]
- [Memory 3]
- [Memory 4]



10 memories are available in all.  
 It is possible to rename the memories.

### c. Manual entry

The entry of the starting refraction can be performed either:

- Eye by eye
- Two eyes at the same time

You can manually enter the patient's refraction data into the phoropter in two different ways:

1. By using the console touch screen, or
2. By using the console keyboard.

#### 1 - Using the console touch screen

- 1 Press on the setting which you wish to enter.
  - Sphere (S)
  - Cylinder (C)
  - Axis (A)



The selection can be done independently for the right eye, the left eye or in binocular.

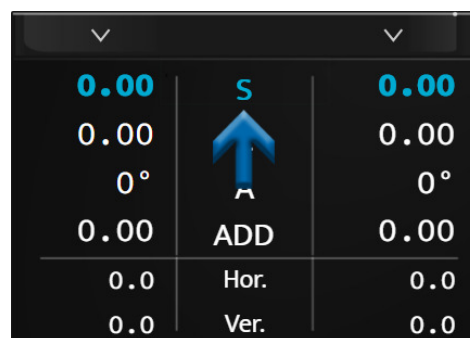

- > The line of the selected setting is displayed in blue. Press the selected parameter again to display the numeric keypad.

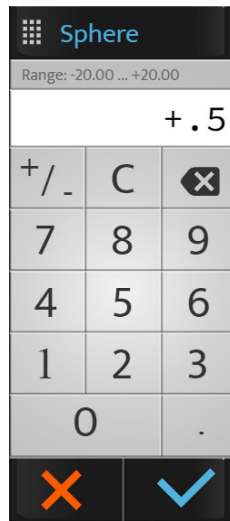

2 Enter the desired value and press:

- o ✓ to confirm.
- o ✗ to cancel.

- > The data is displayed on the screen and is applied in front of the eye or the eyes of the patient.

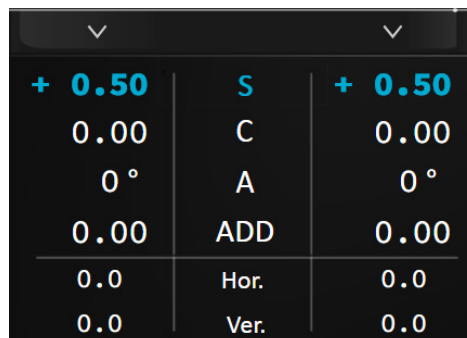

3 Then press on other settings if necessary.

## 2 - Using of the console keyboard

1 Press on the keys [R, BINO or L].

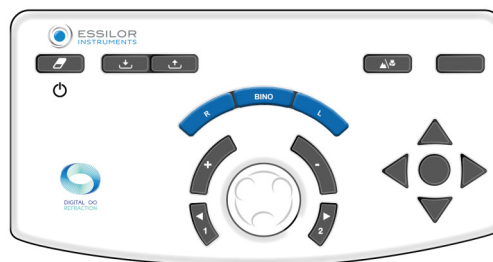

2 Turn the console keyboard's central button clockwise (-) or counterclockwise (+).

- > The values of the selected setting change.

3 Press on the central button on the keyboard to change the setting if necessary.



Do not forget to save the data entered in one of the available memories (here [Lensmeter]).

### 3 - Data memorization

1 Press:

|      |      |      |
|------|------|------|
| 0.00 | S    | 0.00 |
| 0°   | C    | 0.00 |
| 0.00 | A    | 0°   |
| 0.0  | ADD  | 0.00 |
| 0.0  | Hor. | 0.0  |
| 0.0  | Ver. | 0.0  |

> The list of the available memories is displayed.

|              |
|--------------|
| Save         |
| Lensmeter    |
| Autorefracto |
| Retinoscopy  |
| Patient File |
| Memory 1     |
| Memory 2     |
| Memory 3     |
| Convert      |
| Adjust       |

- 2 Choose the desired memory.
  - > The saved data is displayed on the right part of the screen.

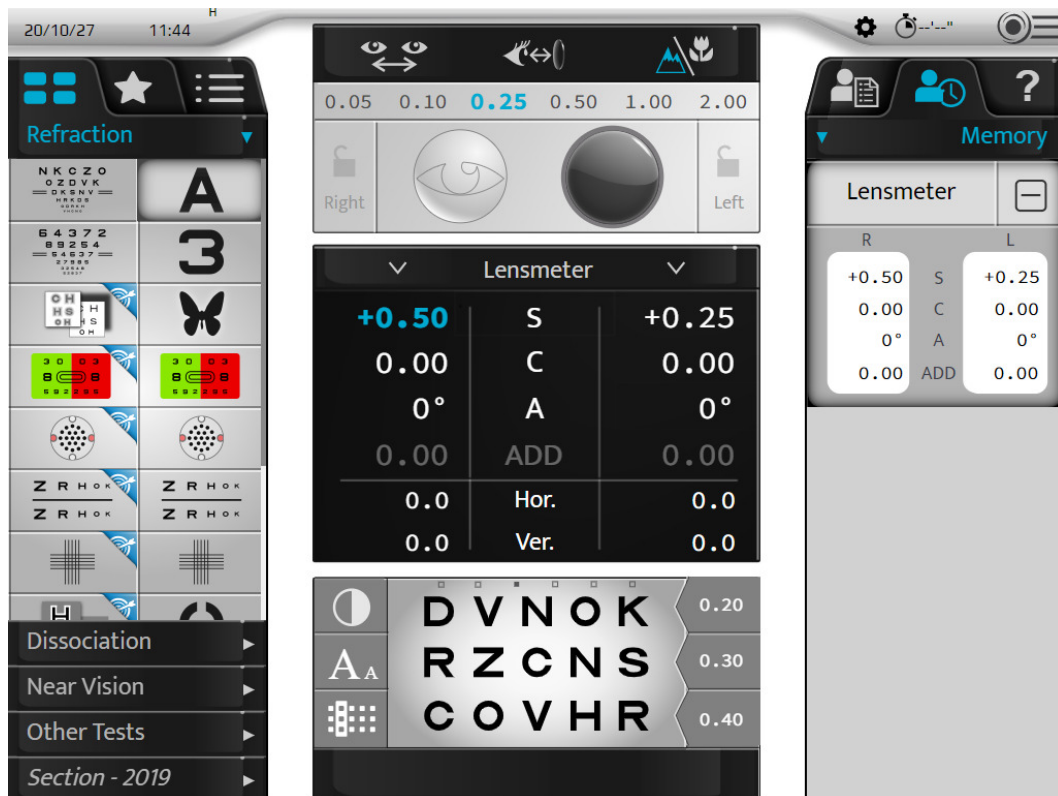

## 2. Standard tests

There are three types of standard tests:

1. The far-vision refraction tests
2. The binocular-vision tests
3. The near-vision tests

### a. Refraction tests

The following refraction tests will be detailed:

- Visual acuity
- Red/Green or Duochrome
- Fixed cross cylinders
- Reserved cross cylinders
- Bi-ocular balance



This list is not exhaustive.

Some main tests are only detailed here to help understand operation of the instrument.



For each test, a contextual “in situation” help is available by pressing on .

User is prompted to refer to this.

**Reminder**

Before performing the refraction tests, it is recommended to first enter the data of the patient's initial refraction into the instrument.

This data can come from:

1. The previous measured refraction on the glasses of the patient,
2. The objective refraction:
  - measured with the auto-refractometer or a skiascope,
  - determined by an aberrometer.
3. The patient folder.

Visual acuity**Objective**

Measure the visual acuity of the patient with and/or without correction in:

- Far vision,
- Monocular vision condition:
  - right eye (RE),
  - left eye (LE),
- Binocular vision condition (RLE i.e. RE and LE simultaneously).

**Choice of optotypes scale**

It is possible to choose two types of optotypes scales:

1. Rational progression scale (in opposite and decimal acuity)
  - letters
  - numbers
  - C of Landolt
  - E of Snellen
  - stylized figures
2. Logarithmic progression scale
  - letters
  - numbers
  - C of Landolt
  - E of Snellen

Once you have made your choice, press on the icon of the desired test. The visualization of the test is then displayed at the bottom of the main screen:

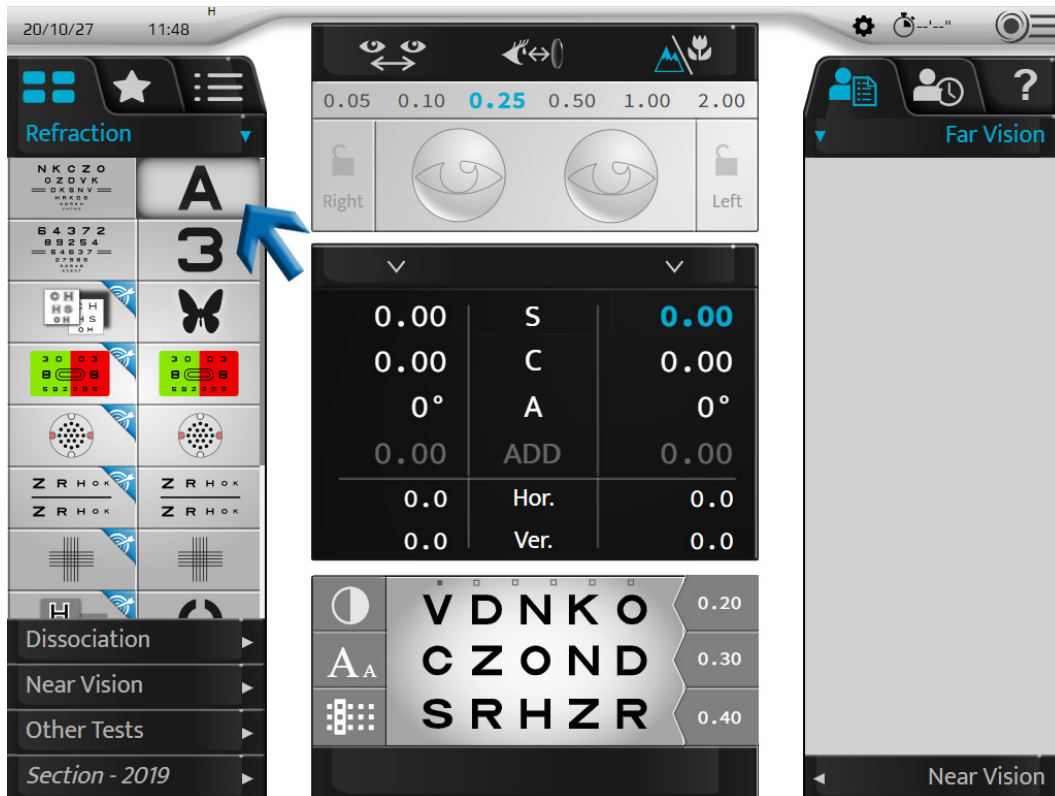

The test display area allows you to:

- Visualize the optotypes presented.
- Display the acuity values in the unit chosen during configuration:
  - decimal acuity (x/10)
  - Snellen acuity in meters (6/x)
  - Snellen acuity in feet (20/x)











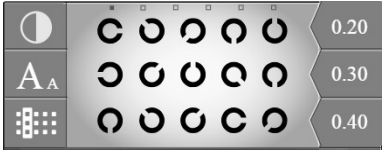

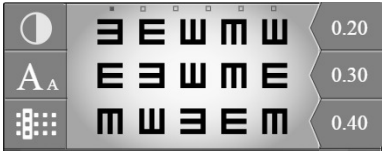

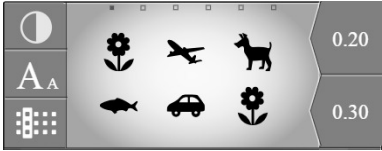
The table of optotypes allows you to:

- Display the value of corresponding acuity,
- Display the unit of acuity.

#### Choice of optotypes scale

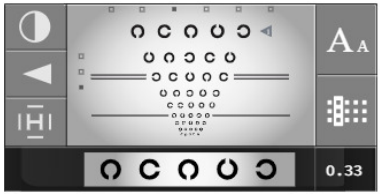
| Scales of acuity           | Types   | Icons    | Display zone at the bottom of the screen |
|----------------------------|---------|----------|--|
| Rational progression scale | letters | <b>A</b> |  |
|                            | numbers | <b>3</b> |  |

|                               |                  |   |   |
|-------------------------------|------------------|---|---|
|                               | C of Landolt     |    |    |
|                               | E of Snellen     |    |    |
|                               | stylized figures |    |    |
| Logarithmic progression scale | letters          |    |    |
|                               | numbers          |   |   |
|                               | C of Landolt     |  |  |
|                               | E of Snellen     |  |  |



So that the patient does not memorize the series, for each scale of acuity, six series of optotypes are available. You can change the series while maintaining the same letter size:

- On the touch screen, by pressing on the points above the optotypes.

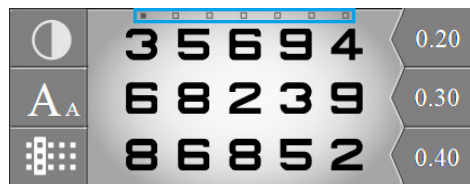

- On the console keyboard, by pressing on the horizontal keys.



### Display of the visual acuity values

To display acuity values, press on **A<sub>A</sub>**.

The acuity values are displayed below the table with the visual acuity value(s) currently being presented highlighted in blue.

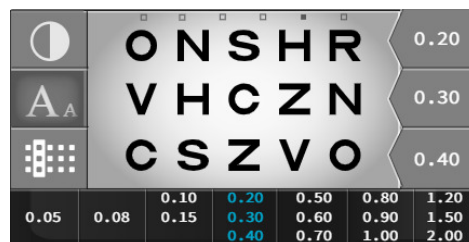

You can change the visual acuity values on the console keyboard by pressing on the vertical keys:



Record the patient's acuity value by pressing the key in the middle of the four arrows or by pressing on the acuity value on the screen.

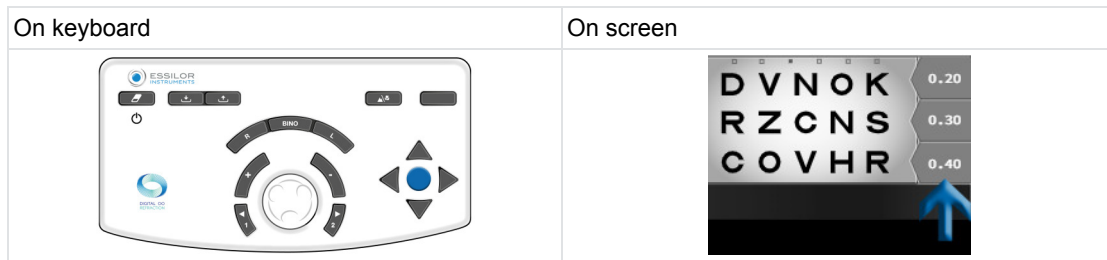





### Choice of optotype table display

To choose a kind of display press on **⋮**.

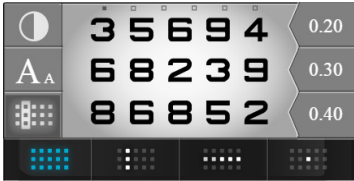
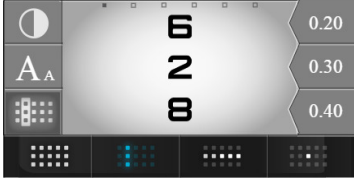
It is possible to choose four display types of optotypes:

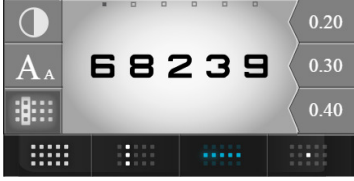
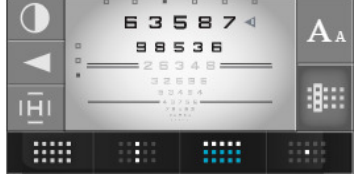

1. In table
2. In column
3. In line
4. In isolated optotype

| Display types                                  | Display in zone at the bottom of the screen  |
|--|--|
| Table  |    |
| Column   |    |
| Multiple column (press on the same icon again) |   |
| Line   |  |
| Multiple line (press on the same icon again)   |  |
| Isolated optotype                              |  |

**Fix patient focus**

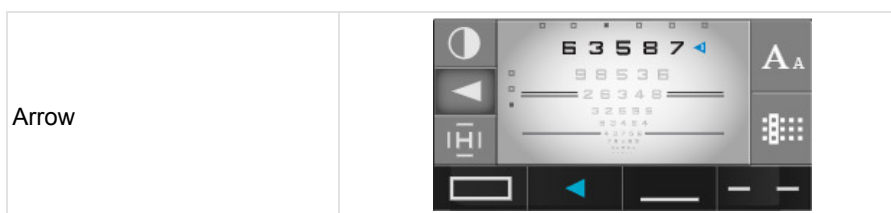
In this section, the ECP can fix the focus of the patient on a specific area. Press . Now it is possible to focus from:

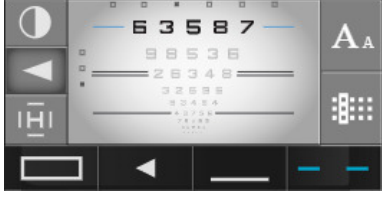

|                |  |
|----------------|--|
| Block          |  |
| Underline      |  |
| Opposite lines |  |

### Choice of contrast type

To choose a type of contrast, press on .

It is possible to choose three types of contrasts:

1. Red-green, in 100% contrast,
2. White on black background
3. Black on white background, with choice of contrasts from 0 to 100%.



### Procedure - Determine the visual acuity of the patient

- 1 Select the optotypes on the touch screen.



Check that the optotypes that appear correctly on the test presentation screen.

- 2 Select the right eye, the left eye or both eyes by using the keys [R, L or BINO] on the console keyboard.

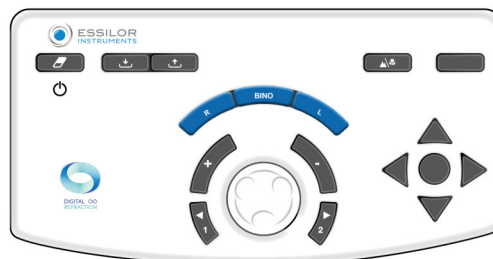

- 3 Scroll through the acuity tests using the vertical arrows on the console keyboard.



- 4 Ask the patient the following question:  
*“Look at the test, what is the smallest symbole line that you can make out without squinting?”*
  - > If the patient manages to make out 3 out of 5 optotypes on the same line of acuity, the level of acuity is considered as achieved.
- 5 Save the visual acuity value. You can save this value:
  - o On the console keyboard, by pressing on the key located in the middle of the 4 arrows.



 Only for rational scale if a line or a symbol is isolated.

- o On the touch screen, by pressing on the acuity value appearing in the display area.



- > The value of the visual acuity of patient (RE, LE or BINO) changes into blue and is saved in the section “Patient Data”, in the memory “Visual Acuity”.

> It appears in the dial on the right of the screen.

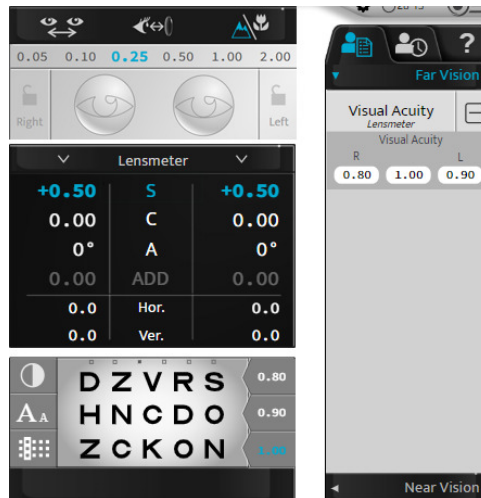

Red/Green or Duochrome (non-smart test)

**Objective**

Adjust the patient's spherical correction value in:

- Far vision,
- Monocular vision condition:
  - right eye (RE),
  - left eye (LE),
- Binocular vision condition (RLE i.e. RE and LE simultaneously).

### Procedure - Performing the test

1 Press .

> The Red/Green test is displayed in the display area in the bottom of the touch screen of the console.



> The corresponding table of optotypes is displayed on the test presentation screen.



To perform this test in the best conditions, a more softly lit environment is advised.

2 Ask the patient the following question:

*"Look at the test, do the characters seem clearer in the green background, on the red background or do they appear identical on both backgrounds?"*

If the answer is:

- > - **clearer on the red background** add -0.25 D (\*) to the value of the sphere. Either:
  - o On the console keyboard, by pressing on the key " - ".

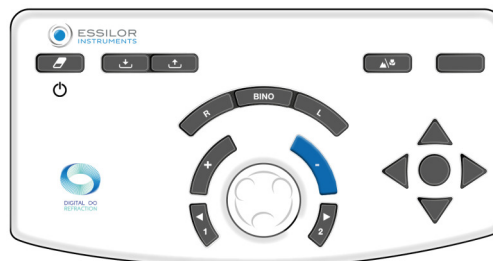

- On the console keyboard, by turning the central button clockwise (\*).



> Start the test again until the patient sees the equal blackness for the characters on the red background and the green background or the preference for the green background.

- **clearer on the green background** add +0.25 D (\*) to the value of the sphere. Either:
  - On the console keyboard, by pressing on the key “+”.

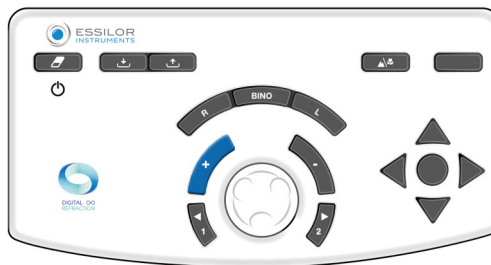

- On the console keyboard, by turning the central button anticlockwise (\*).



> Start the test again until the patient sees the equal clarity for the characters on the red background and the green background or the preference for the red background.

- **identical on the red background and the green background** retain this sphere value.

In the event of preferred red and green inversion between two sphere steps, retain the last values:

- red** for a patient **with myopia**
- green** for a patient **with hypermetropia**

## Notes

- To avoid the disturbing effects of the accommodation of the patient (which can make him prefer the red), it is possible to:
  - ask the patient to look on the green background before proceeding to the red/green comparison,
  - lightly blur by adding a power of +0.50 D in order to obtain a preference for the red and to then clear it up until obtaining the balance between the red and the green.
- Several successive preferred answers for the red can indicate that the patient unintentionally involves his accommodation. This can occur in particular with young patients who can sometimes appear short-sighted by the excessive inclusion of their accommodation. It is thus important to make sure not to let it result in a too concave (or negative) sphere value.



(\*)

This information corresponds to the phoropter default settings. The **sphere variation step is by default 0.25 D** but can be adjusted in settings.

Fixed cross cylinders

**Objective**

Adjust the patient's spherical correction value in:

- Far vision,
- Monocular vision condition:
  - right eye (RE),
  - left eye (LE),
- Binocular vision condition (RLE i.e. RE and LE simultaneously).

**Procedure - Performing the test**

1 Press .

- > A cross made up of black horizontal and vertical lines on a white background is displayed in the display area at the bottom of the touch screen on the console.

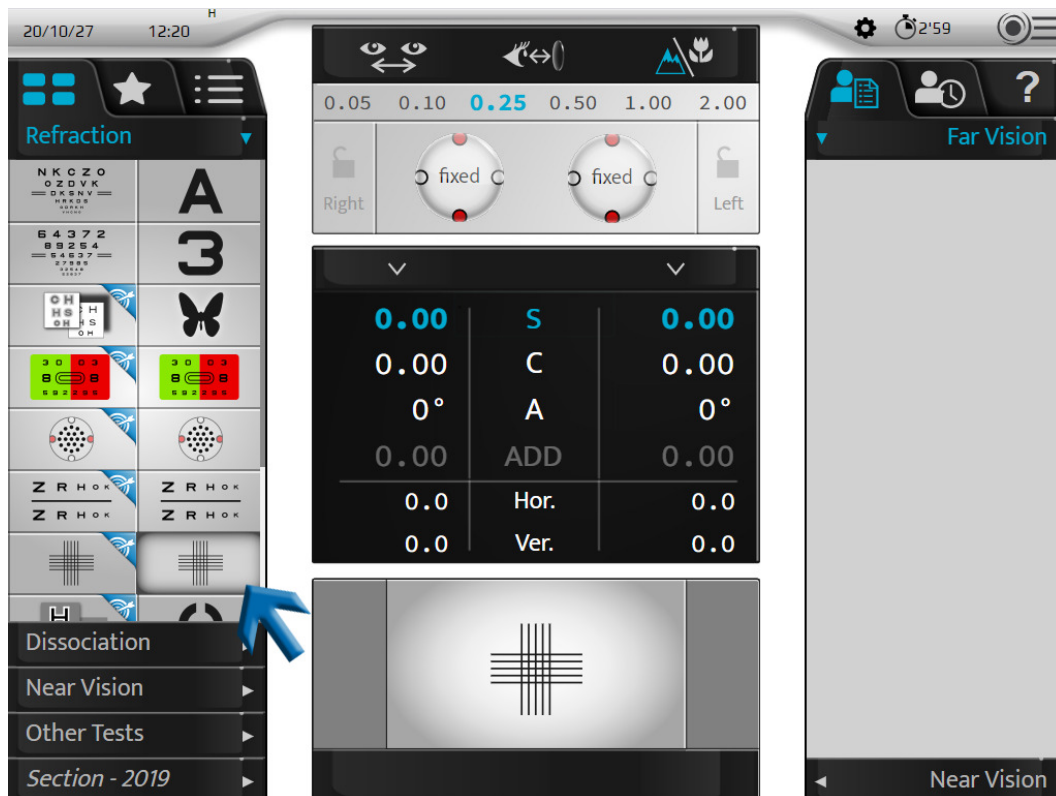

- > A cross is displayed on the test presentation screen.
- > A fixed cross cylinder with a “+0.50 (- 1.00) 90°” formula is added to the patient's correction (on the right eye, the left eye or both eyes).



This cylinder is **automatically** generated by the optical module through combination with the patient's correction. It is not an additional lens added in front of the correction of the patient (as in the traditional phoropters).

2 Ask the patient the following question:

*“Look at the cross. Tell me if the horizontal or vertical lines appear clearer to you or darker or if they have the same darkness.”*

If the answer is:

- > - **clearer vertical lines** add -0.25 D (\*) to the value of the sphere. Either:
  - o On the console keyboard, by pressing on the key “-”.



- o On the console keyboard, by turning the central button clockwise (\*).



> Start the test again until the patient sees equal clearness between the horizontal and vertical lines or a greater clearness for the horizontal ones.

- > - **clearer horizontal lines** add +0.25 D (\*) to the value of the sphere. Either:
  - o On the console keyboard, by pressing on the key “+”.

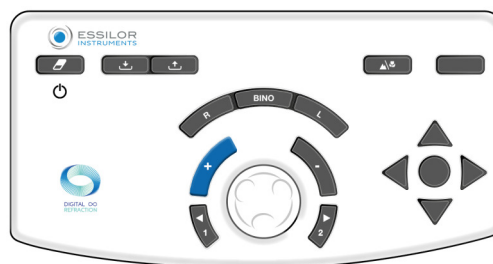

- o On the console keyboard, by turning the central button anticlockwise (\*).



- > Start the test again until the patient sees equal clearness between the horizontal and vertical lines or a greater clearness for the vertical ones.
  - > **- equality of darkness between the horizontal and vertical ones** retain this sphere value.
- In the event of preferred inversion between the horizontal and vertical lines between two sphere steps, retain the last values:
- **vertical** for a patient **with myopia**
  - **horizontal** for a patient **with hypermetropia**

### Notes

- To avoid the disturbing effects of accommodation, it is possible to blur the patient (with a convex power) until you obtain the preference for the vertical lines and to then clear up it until you achieve a balance between the horizontal and vertical lines.
- The test of the fixed cross cylinders supposes an exact correction of the astigmatism of the eye. The result can be distorted if a direct astigmatism (cylinder axis further from 0°) or the opposite (cylinder axis further from 90°) is over or under-corrected.
- At the end of the test, the horizontal and vertical lines are slightly fuzzy (because the patient looks at them through a cylinder of 1.00 D). The important thing is that the blurring is identical on the horizontal and vertical lines.



(\*)

This information corresponds to the phoropter default settings. The **sphere variation step is by default 0.25 D** but can be adjusted in settings.

### Reserved cross cylinders

#### Objective

Determine the value of the patient's cylindrical correction:

- Axis,
- In power,
- In far vision,
- In single-eyed vision (right eye or left eye).



Historically, the reserved cross cylinders test was performed using a lens made up of a positive cylinder and a negative cylinder of the same powers and perpendicular portions between them. This lens was mounted on a shaft and allowed the position of positive and negative cylinders to be manually reversed by turning the lens over itself.



Unlike traditional manual and automated phoropters, there is no reversal in the Vision-R™ 800 or "changing" lens manuals. The cross cylinder move positions instantaneously. It is determined by a calculation which, in combination with the correction in place, is directly generated by the optical module. The patient sees a change occurring instantly and without interruption and thus perceives differences more easily.

#### Principle

The principle of the test is to combine the astigmatism of the lens with the uncorrected residual cylinder value of the eye (the one resulting from the combination of the eye's astigmatism and the correction in place).

- If the astigmatism is properly corrected, the patient does not perceive any difference between the positions of the cross cylinder. They are seen as equally blurred.
- If the astigmatism is not perfectly corrected, the patient perceives a blurring difference between the different positions of the cross cylinder.

The reversed cross cylinder test takes place in three stages:

1. Cylinder axis search
2. Cylinder power search
3. Sphere power adjustment (based on the cylinder value)



### Reminder - cylinder axis search

The search for the cylinder axis consists of comparing two positions:

1. The negative axis of the corrective cylinder
2. The cylinder axis of the patient correction

If the axis of the correction is correct, the patient does not perceive any difference between the two positions.

However, if the patient perceives a difference between the two positions, the correction axis must be adjusted by 5° (\*) in the direction of the negative axis of the preferred cross cylinder. The operation must be repeated until the patient no longer perceives a difference between the two positions or indicates a return to the previous axis position.



### Reminder p Cylinder power search

The search for the cylinder power consists of positioning the meridians of the cross cylinder according to the direction of the axis of the correction and comparing the two positions of the cross cylinder.

If the power of the cylinder is correct, the patient does not perceive a difference.

However, if the patient perceives a difference it is necessary to modify the power of the cylinder. If the patient prefers:



- The position of the cross cylinder with the negative axis aligned with that of the correction: it is necessary to **increase** the negative cylinder value of the correction by 0.25 D (\*).
- The position where the negative axis of the cylinder is perpendicular to the axis of the correction (corresponds to the positive cylinder axis aligned with that of the correction): it is necessary to **reduce** the cylinder value by 0.25 D (\*).

Repeat the operation until the patient no longer perceives a difference or indicates a return to the previous position of the cross cylinder.

**Note:** after a change of 0.50 D to the cylinder, do not forget to adjust the sphere power of 0.25 D in order to maintain the constant equivalent spherical power.

**Procedure - Test Performance, Step 1 Cylinder Axis Search**

1 Press .

 This test can also be performed with a letter target .

> The reversed cross cylinder test is displayed in the display area in the bottom of the touch screen of the console.

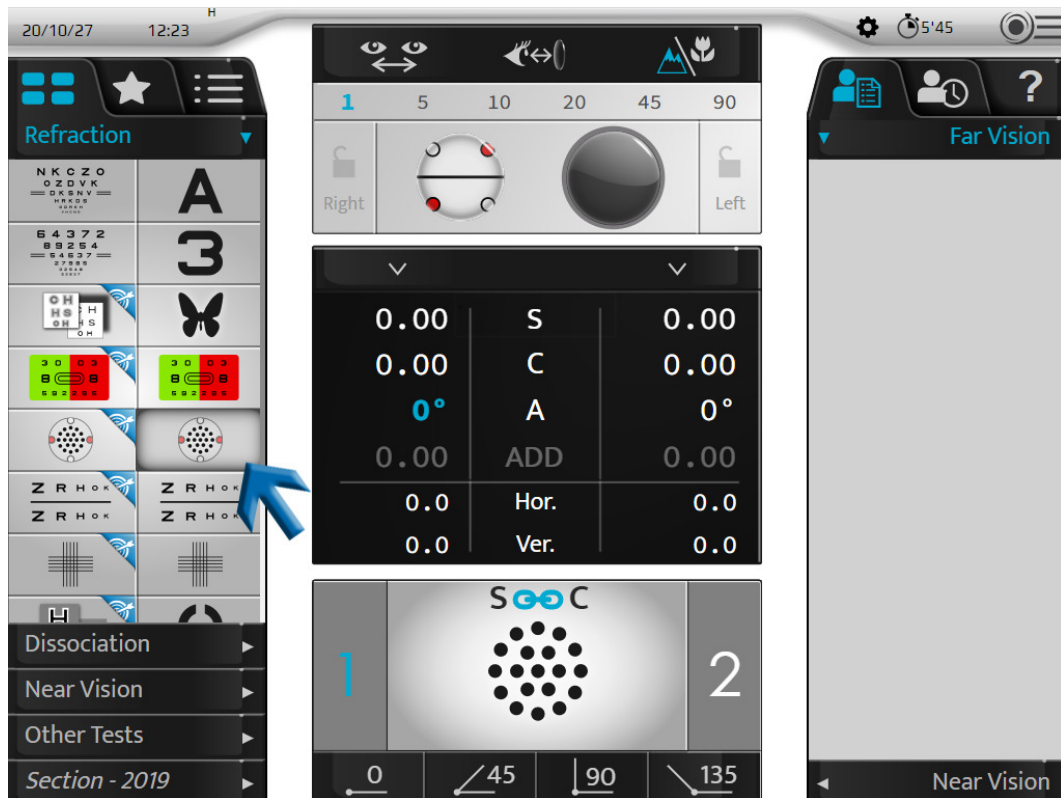

- > The dot test is displayed on the test presentation screen.
- > The cross cylinder is placed in the cylinder axis verification position, oriented according to the direction of the negative axis of the patient's correction cylinder.

This axis is visually represented by the black line below.



The white dots represent the positive axis.



It is also possible to place it directly in the axis search position by clicking once on the value of the cylinder axis for the eye concerned.

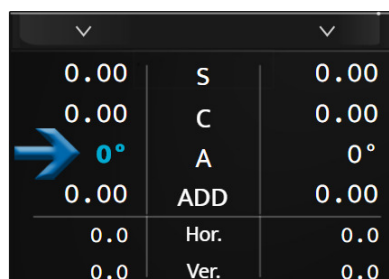



2 Ask the patient the following question:

"Look at the dots. Tell me if they look sharper, darker, more contrasted in position 1, position 2 or if they look identical to you?"



To:





|  |  |
|--|--|
| <p>Show the dots in position 1, press the "1" key on the console keyboard.</p>           |  |
| <p>To show the dots in position 2, press, press the "2" key on the console keyboard.</p> |  |



It is important to always propose the three options:

- o Position 1
- o Position 2
- o Same

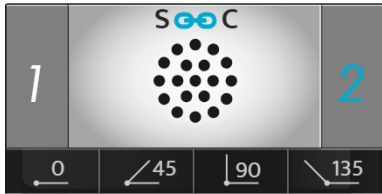
> The position change appears in the test presentation area in two ways:

| Blue highlighting of positions 1 and 2  | Cross cylinder position change   |
|---|--|
|  |  |
|  |  |



Reminder:

- o The red points mark the negative axis of the cross cylinder
- o The white points mark the positive axis of the cross cylinder

If the answer is:

> - **clearer in position 1**, press the + key on the console keyboard:



The axis (the negative cylinder of the correction and the cross cylinder) rotate in the direction of the negative axis of the patient's preferred position(\*).

> Repeat the test until the patient no longer sees any difference between the two positions in the cross cylinder.

- > - **clearer in position 2**, press the + key on the console keyboard:

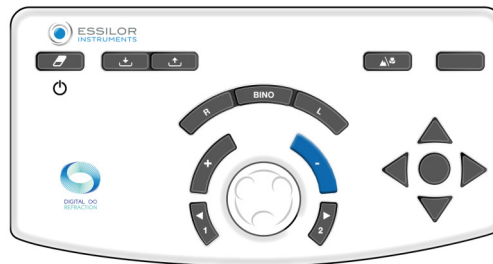

The axis (the negative cylinder of the correction and the cross cylinder) rotate in the direction of the negative axis of the patient's preferred position (\*).

> Repeat the test until the patient no longer sees any difference between the two positions in the cross cylinder.

- > - **no difference**, press on the keyboard's central button on the console:

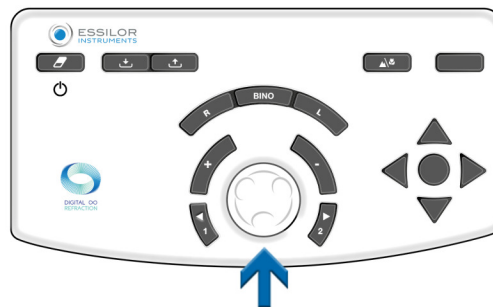

> Retain this value for the cylinder axis.

- > The refraction head then is automatically set up in the cylinder power verification position.

If you prefer to reverse position 1 to position 2, hold the first value of the axis or a middle value. Validate it using the central button on the console keyboard.

**Notes**

If no starting cylindrical correction is available, first locate the cylinder axis on a range of 45° by comparing positions 0° and 90°, then 45° and 135°.

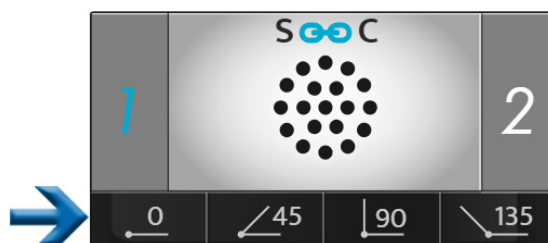

It will be necessary to place a negative cylinder of -0.50 D in the specified range of 45° and then perform the above procedure.



(\*)

This information corresponds to the phoropter default settings.

- The **no change in cylinder axis is by default 5°** but can be adjusted in settings.
- It can also be modified during the examination by selecting it in the steps display area.



### Procedure - Test run, step 2 cylinder power search

- 1 Select the power of the cylinder. Either:
  - On the console keyboard, by pressing on the central button.

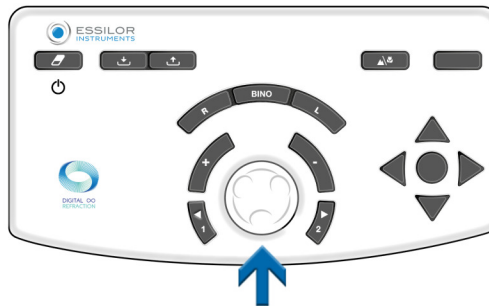

- On the touch screen of the console, by clicking once on the setting value of the particular eye.

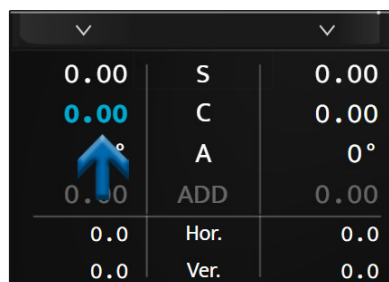

- > The cross cylinder is positioned in the power verification position of the cylinder, oriented according to the direction of the negative axis of the corrective cylinder for the patient correction.





It is turned 45° from its position when searching for the cylinder axis.

2 Ask the patient the following question:

"Look at the dots. Tell me if they look sharper, darker, more contrasted in position 1, position 2 or if they look identical to you?"



To:



|   |  |
|---|--|
| <p>Show the dots in position 1, press the "1" key on the console keyboard.</p>    |  |
| <p>To show the dots in position 2, press the "2" key on the console keyboard.</p> |  |



It is important to always propose the three options:

- o Position 1
- o Position 2
- o Same

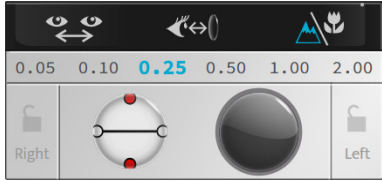
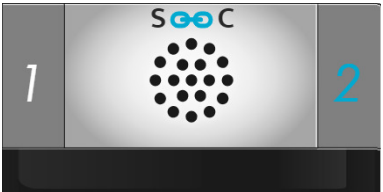
> The position change appears in the test presentation area in two ways:

| Blue highlighting of positions 1 and 2  | Changing of cylinder axis position   |
|---|--|
|  |  |
|  |  |



Reminder:

- o The red points mark the negative axis of the cross cylinder
- o The white points mark the positive axis of the cross cylinder

If the answer is:

> - **clearer in position 1**, press the + key on the console keyboard:

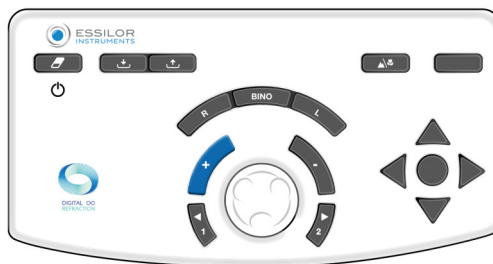

The negative cylinder value of the correction is then reduced by +0.25 D.

> Repeat the test until the patient no longer sees any difference between the two positions in the cross cylinder.

> - **clearer in position 2**, press the + key on the console keyboard:



The negative cylinder value of the correction is then increased by -0.25 D.

> Repeat the test until the patient no longer sees any difference between the two positions in the cross cylinder.

> - **no difference**, press on the keyboard's central button on the console:

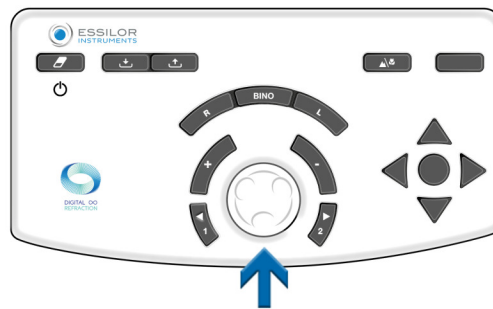

> Retain this value for the cylinder power.

If preferably reversed between position 1 and position 2, retain the lowest value of the two cylinder values found.



(\*)

This information corresponds to the phoropter default settings.

- The variation step of the cylinder power is by default 0.25 D, but it can be adjusted in the settings.
- It can also be modified during the examination by selecting it in the steps display area.



### Procedure - Test run, step 3 sphere power adjustment

1 Adjust the sphere value to maintain the constant spherical equivalent.



Perform this operation in case two power step variations have been made.

Example: if -0.50 D cylinder has been added, the sphere should be adjusted by +0.25 D (\*).

- 2 This adjustment, by correction of the sphere, is manual. You can do it:
- On the console keyboard, by pressing on the central button.

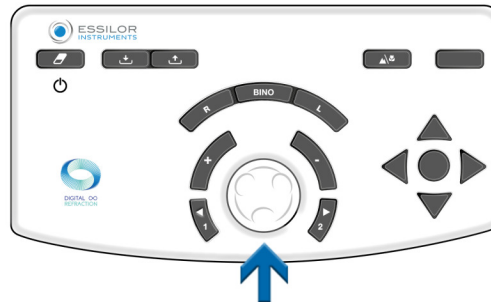

- On the touch screen of the console, by clicking once on the setting value of the particular eye.

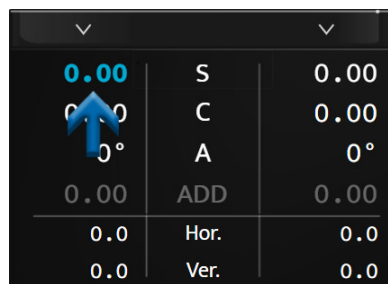

(\*)

If the variation step in the cylinder power was chosen at a value other than 0.25 D, the automatic adjustment of the sphere power will also occur after two variation steps in the cylinder.

For example: if the pitch is 0.10 D, the sphere value will be corrected by +0.10 D after a change in cylinder power of -0.20 D.

### Bi-ocular balance

#### **Objective**

Adjust the equilibrium of corrections between the right and left eye in a bi-ocular vision condition (both eyes open but simultaneously perceiving different targets).

#### **Principle**

The principle of the test is to slightly blur the patient's vision by introducing a power of +0.50 D (or +0.75 D) in front of both eyes to make it easier to compare the vision of the right eye and the left eye.



It is easier to compare two fuzzy visions to two sharp ones.

If the patient sees more clearly with one eye than with the other, blur the eye that sees the best, increasing the power by +0.25 D (or +0.10 D or +0.05 D depending on the chosen step) so as to obtain a blurred vision balance between the two eyes.

Once the equilibrium has been achieved, remove the previously introduced +0.50 D (or +0.75 D) power and retain the power, if any, added on one of the two eyes.

#### **Note**

The practice of bi-ocular equilibrium testing assumes that the visual acuity of both eyes is identical or similar.

In the case of significantly different visual acuities between the right and left eye, a polarized red/green test or a vertical prism dissociation test should be used. It will allow the patient to simultaneously take a different red/green test for each eye. It will then be possible to simultaneously search for red/green equality for each eye, with both eyes open.

### Procedure - Performing the test

1 Press .

> The bi-ocular equilibrium test is displayed in the display area at the bottom of the touch screen of the console.



- > The polarized filters are placed in front of the patient's eyes so that the vision is separated from the eyes.
- > Masks are displayed .
- > Two polarized letter lines appear on the test presentation screen.



The patient can see:

- o The upper line with the right eye (\*)
- o The bottom line with the left eye (\*)

- 2 Insert the +0.50 D (or +0.75 D) power in front of both eyes (so as to slightly blur the patient's vision).



You can introduce the power in two ways. By pressing [Bino] and then (once the "S" parameter is selected):

1. By turning the center button counterclockwise twice (+0.50 D) or three times (+0.75 D).



2. By pressing the "+" key twice (+0.50 D) or three times (+0.75 D).

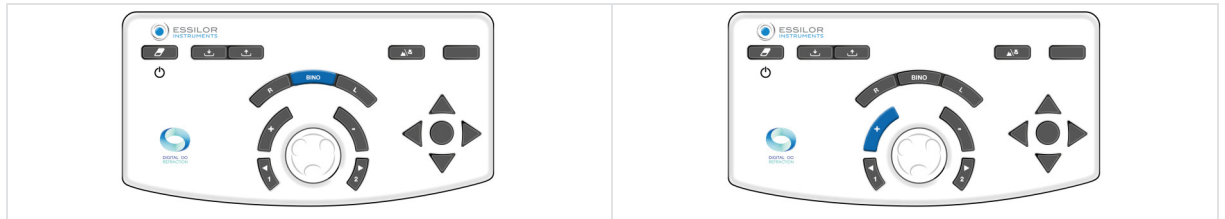

- 3 Ask the patient the following question:

*"Look at the two lines of letters. Tell me if the letters look clearer on the top line, on the bottom line, or if they look identical to you?"*

If the answer is:

- > - **sharper letters on the top line**, add +0.25 D (\*) to the value of the sphere on the right eye. To do this:  
Press the [R] key on the console keyboard.

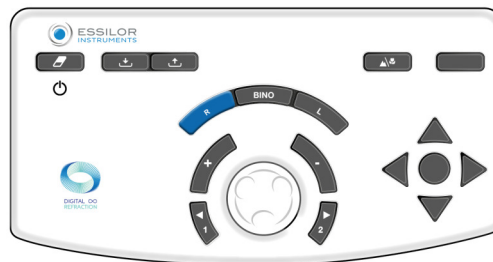

On the console keyboard:

- o Press the "+" key.

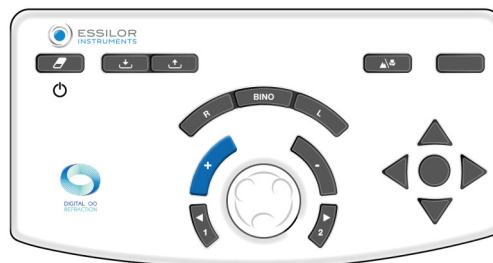

- Or, turn the center button counterclockwise (\*).



> Repeat the operation until the patient sees a balance in the blurred vision between the top and bottom lines or its reversal.

- > - **sharper letters on the bottom line** add +0.25 D (\*) to the value of the sphere on the left eye. To do this: Press the [L] key on the console keyboard.



On the console keyboard:

- Press the "+" key.

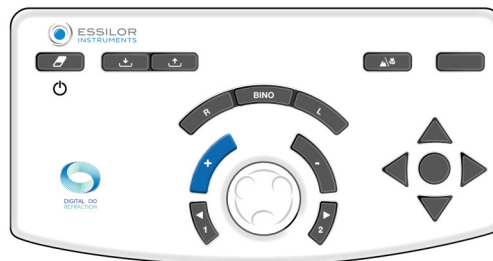

- Or, turn the center button counterclockwise (\*).



> Repeat the operation until the patient sees a balance in the blurred vision between the top and bottom lines or its reversal.

> - **identical letters on top and bottom lines**, bi-ocular equilibrium is achieved. Note this value.

In case of preferred inversion between the top and bottom lines between the proposals:

- o Reduce the gap in the variance step to determine the exact bi-ocular equilibrium or
- o Keep the balance that gives preference to the dominant eye of the patient.



The dominant eye of the patient is determined during preliminary refraction tests.

4 Once bi-ocular equilibrium has been achieved, remove the +0.50 D (or +0.75 D) powers introduced at the beginning of the test.



You can remove the power in two ways. By pressing [Bino] and then (once the "S" parameter is selected):

1. By turning the center button clockwise twice (+0.50 D) or three times (-0.75 D).

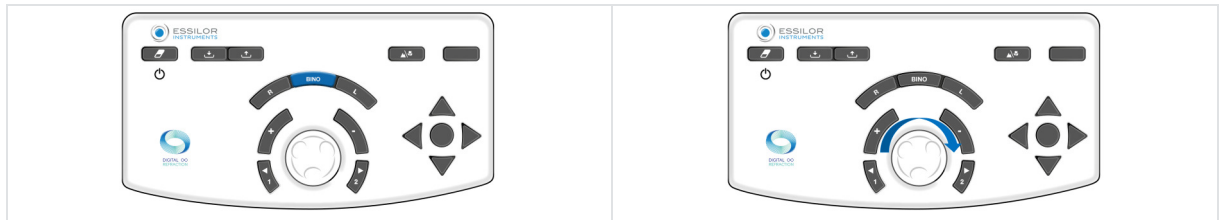

2. By pressing the "-" key twice (-0.50 D) or three times (-0.75 D).

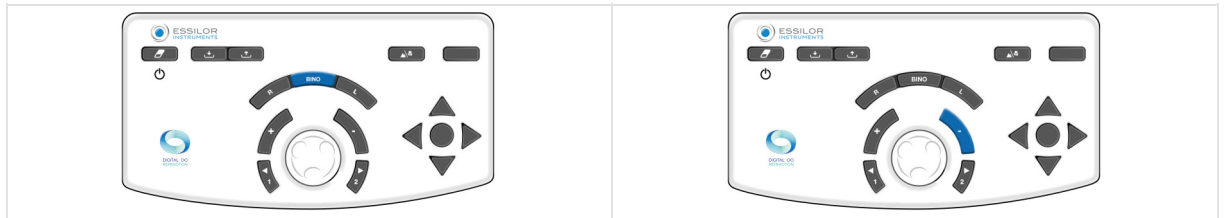

Following the bi-ocular equilibrium test, perform a binocular sphere check with the red/green test (to be performed with both eyes open).

## Notes

- If the patient reports that the lines appear and disappear or shift horizontally or vertically, he is likely to have a binocular vision problem (difficulty simultaneously viewing or merging images).
- It is worthwhile to ask the question routinely at this stage of the test in order to ensure that the patient has simultaneous vision in both eyes and that the patient's vision is stable.



(\*)

This information corresponds to the phoropter default settings. The **sphere variation step is by default 0.25 D** but can be adjusted in settings.

## b. Near vision tests

Near vision tests to be performed with rod and near point chart.

## 3. Smart tests

A smart test is a semi-automatic test using an algorithm that can determine more precisely the subjective refraction of the patient. At the time of a smart test, all the answers are saved and integrated automatically in order to prescribe the best possible correction.



The smart tests are identifiable through a pictogram located on the right of the icon .



Some main tests are only detailed here to help understand operation of the instrument.



For each test, a contextual “in situation” help is available by pressing on **?**.



All the smart tests function are based on the principle of inserting patient answers and the progression of the algorithm to determine the checked setting. And this, until the right value is found.

## a. Refraction tests

### Red/Green or Duochrome smart test

#### Objective

Refine the patient’s spherical correction value in:

- In far vision,
- Monocular vision condition:
  - right eye (RE),
  - left eye (LE),
- Binocular vision condition (RLE i.e. RE and LE simultaneously).

#### Procedure - Performing the test

1 Press .

> The test view window in the bottom of the touch screen of the console allows you to choose under which conditions the test will be performed (RE, LE, BINO).



- 2 Once the condition is selected, start the test.
  - o On the touch screen by pressing on [Start].



- o On the console keyboard, by pressing on the central button.



- > The Red/Green smart test is shown in the display area in the bottom of the console's touch screen.

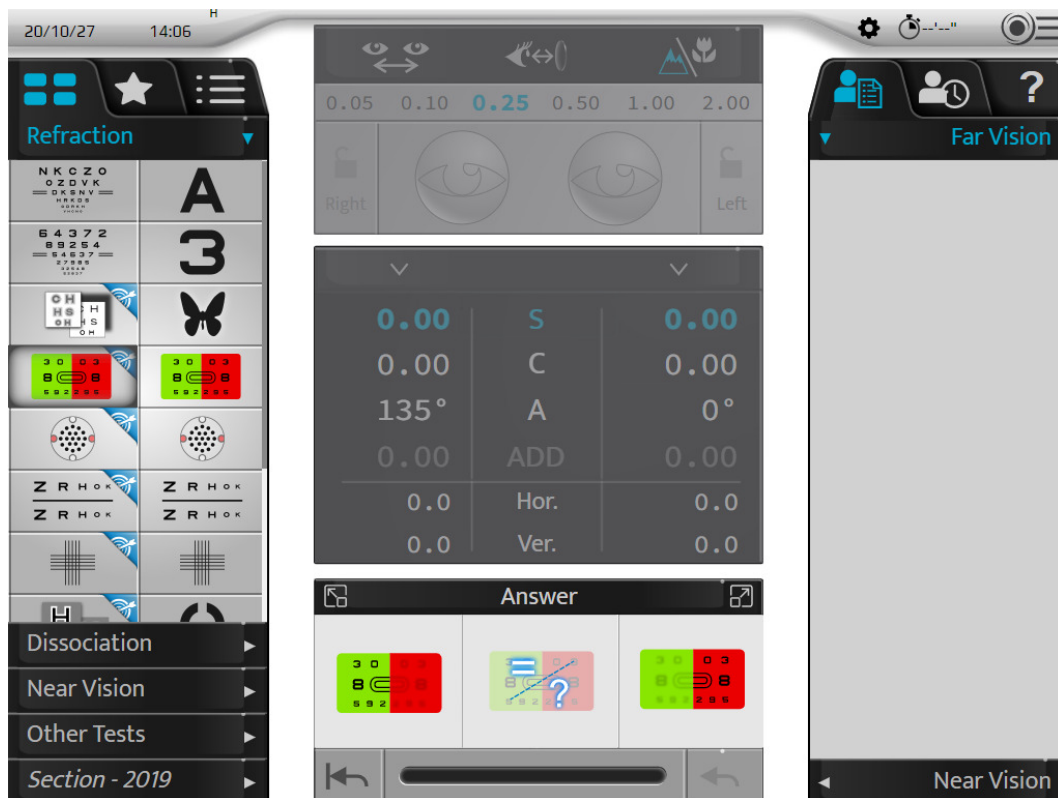

The center part of the screen appears grayed out. It is no longer possible to modify the values of controlled settings, the masks, the filters or the adjustments of the instrument.

- > The corresponding table of optotypes is displayed on the test presentation screen.

- 3 Ask the patient the following question:

*“Look at the characters on the red background and the green background. Do they seem clearer on the red background, on the green background, or do they appear identical on both backgrounds.”*

If the answer is:

- > - **darker on the green background.** Select the answer by either:
  - o Pressing on the corresponding answer on the touch screen.

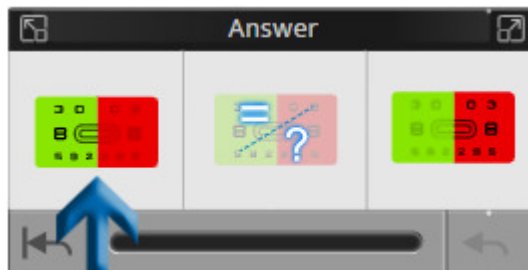

- o On the console keyboard, by pressing on the key “+”.

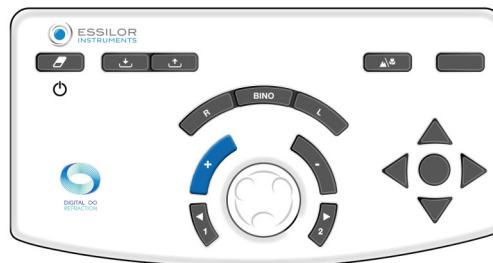

- > - **darker on the red background.** Select the answer by either:

- o Pressing on the corresponding answer on the touch screen.

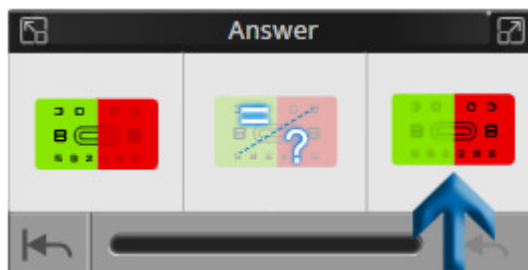

- o On the console keyboard, by pressing on the key “-”.

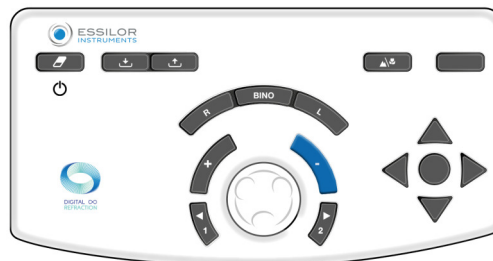

- > - **no preference, doesn't know**. Select the answer by either:
  - o Pressing on the corresponding answer on the touch screen.



- o On the console keyboard, by pressing on the central button.

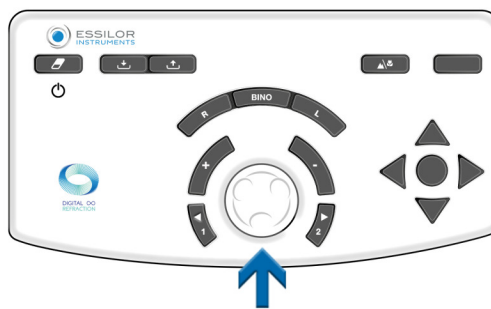

The response window also allows for:

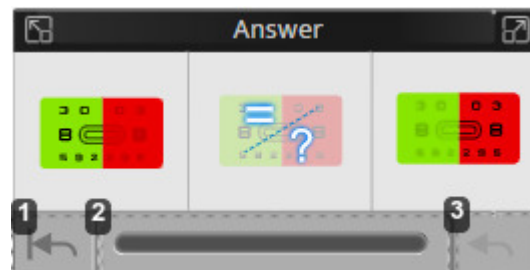

1. *Return to the beginning of the test*
2. *Visualize the progress of the test*  
Three status indications on the progression bar are available.
3. *Cancel the last answer*



An error message may appear, if there is an anomaly during the test.

EXAMPLE:

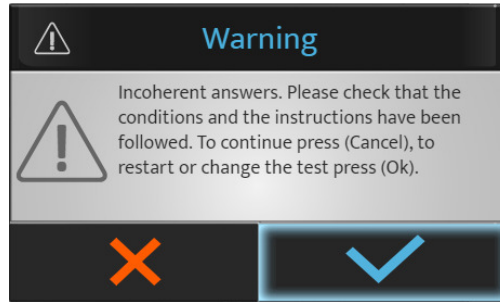

Press:

- ✓ to stop or start the test again.
- ✗ to continue the test.

- 4 At the end of the sequence, close the test by pressing on [Closed].

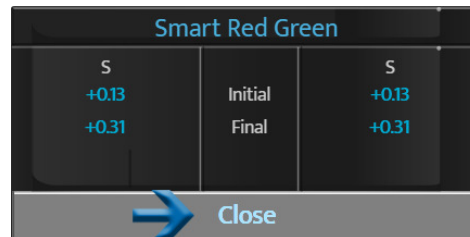

- 5 Select the following test on the touch screen by pressing on the desired test in the available list.



In the case of a test program, moving to the following test is done:

- On the touch screen by pressing on [Next].

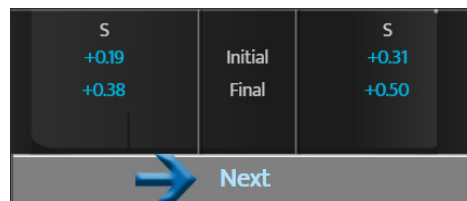

- On the console keyboard, by pressing on the central button.

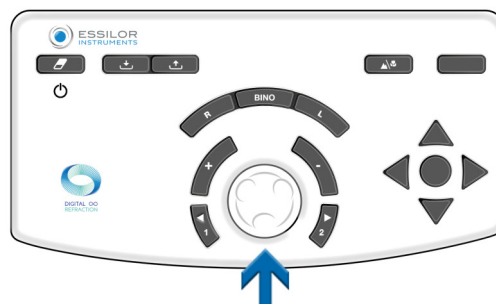

## 4. Refraction to Prescription [PVP]

The [PVP] test [Prescribe Vision Performance] has been developed to assist the ECP in transforming the precise refraction into the final prescription.

Access to the [PVP] test can be done using the action button accessible in the Smart programs after the far vision refraction.



The following screen appears :

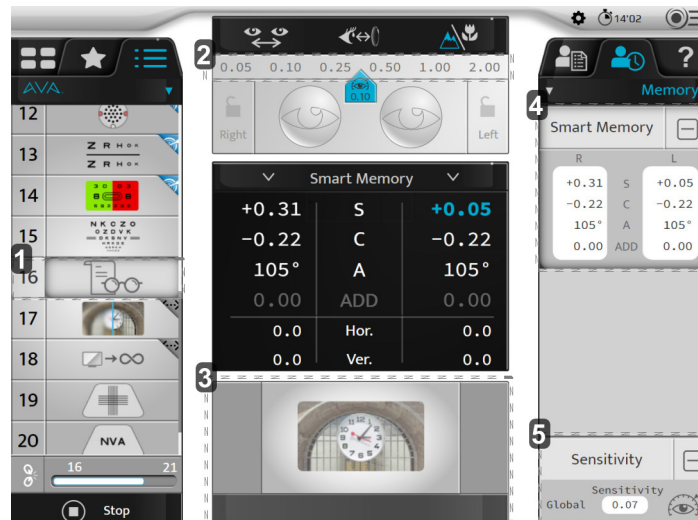

### 1. PVP action button

New test available in the AVA smart program at the end of the far vision refraction to help ECP in adjusting the precise refraction to become the perfect prescription.

### 2. Personalized step

Current step calculated to fit patient's sensitivity.

### 3. Innovative image seen by the patient

Accurate target that include multiple stimuli with high and low frequency, contrast, depth, texture, colors and direction seen by the patient in order to focus on visual performance (clarity and visual performance) while adjusting the refraction.

### 4. Calculation of the differences of correction

The calculation of the differences of correction can be done between new refraction and all the memorized correction such as current spectacles.

It includes the differences of sphere power, cylinder power, anisometropia, axis (in degree and diopter) and near sphere power.

### 5. Sensitivity factor

The sensitivity of the patient is automatically calculated all along the AVA smart program thanks to algorithms and allows us to provide a personalized step used in PVP.

### Example: How to compare new refraction vs previous refraction

Once you reached this step after the far vision refraction, the PVP screen appears.



First, look at the results on the right hand side of the screen to determine which adjustment (sphere, cylinder power, axis...) you need to focus on depending on the differences between the old correction and the new one.

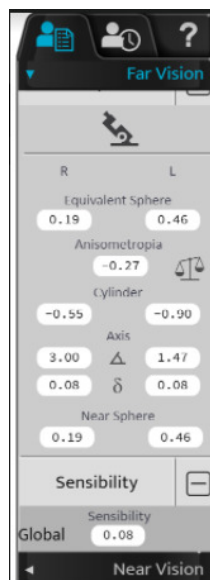

For example, you want to reassure your new refraction is not too concave.

- 1 Click on the binocular sphere value.

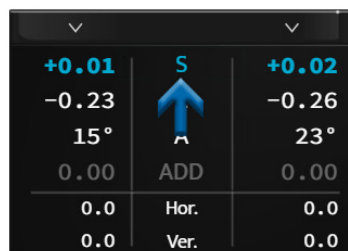

- > The sensitivity step is selected by default at the top.

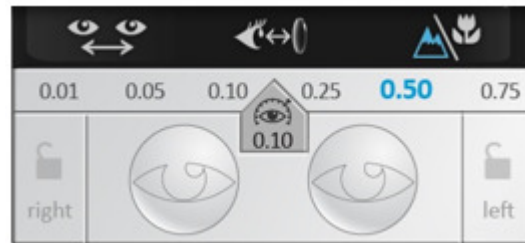

- > The image is already on the screen.

2 Then, ask the patient the following question:

*"Look at the image as a whole. Does the image appear clearer and more comfortable with position 1 or position 2? Please focus on the different textures of the bricks and the window, on the different contrasts and shadows of the clock and the building and on the different lines and curves of the image."*

While the patient is looking at the new image, you can proceed as follow :

- 3 Ask the patient if the image is clear and comfortable with the current lens.
- 4 Add more plus by turning the dial to the left to confirm there is a decrease of comfort, if yes, go to the step 3, if not, continue to add more plus until the comfort decrease.
- 5 Add more minus by turning the dial to the right until no improvement is seen in comfort and clarity.
- 6 Once this point has been reached, you have reached the final prescription.



To be able to perform the [PVP] step, the sensitivity of the patient is needed. To be calculated by our algorithm, at least 2 tests (Smart RG and Smart CC) have to be performed for one eye. On the contrary, the [PVP] icon will inaccessible.

| Available | Non available |
|-----------|---------------|
|           |               |

## 5. Refraction comparison (Bluetouch)

The access to the comparison screen can be done:

- On the console keyboard, by pressing the comparison button.

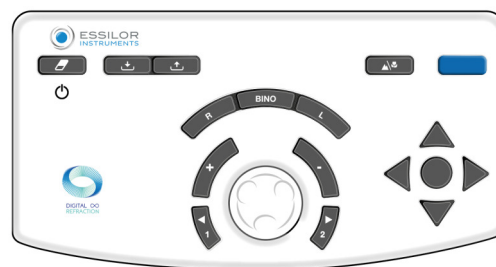

- With the action button which can be set up in a personalized test.

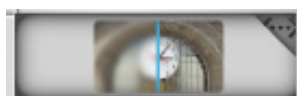

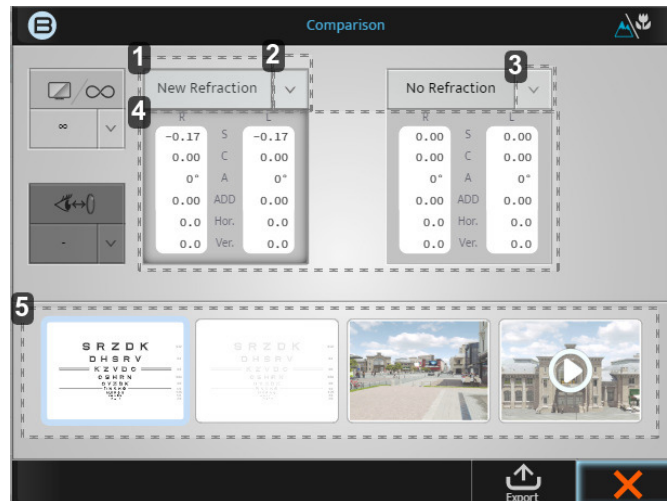

**1. [New refraction] tab**

This value will give the refraction done last and if you press on the block those powers will be displayed.

**2. Down arrow**

Clicking on the down arrow will allow you to select other saved data to compare, such as:

- o Lensmeter
- o Auto-Kerato-Refractometer
- o Etc

**3. Down arrow**

Clicking on the down arrow will allow you to select other saved data to compare, such as:

- o Lensmeter
- o Auto-Kerato-Refractometer
- o Etc

**4. Datas**

If you click on the grey block itself, the power in the phoropter will change to those values.

**5. Display windows**

The 4 display windows will allow you to change the screen being viewed, comparing from log-MAR to 3D, and video.



Once you know what data you want to compare to which image it is always best to switch between the two datas repeatedly and ask the patient which they prefer.

**Example: How to compare new refraction vs previous refraction**

- 1 Once the datas are updated, click on:

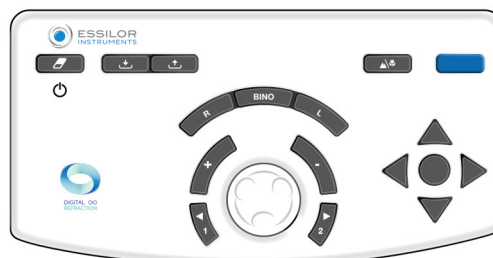

or,



> The following screen appear:



On the initial screen, the default comparison values are [New refraction] and [No refraction]. As you had a lensmeter value in the memory bank, it will automatically have these two comparisons already selected.

For this example you will need to change the [No refraction] to [Lensmeter].

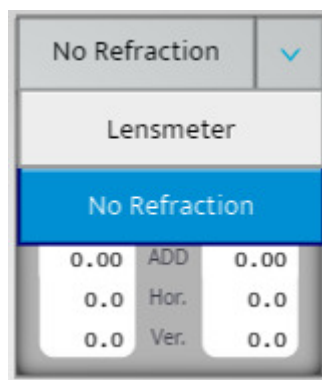

- 2 After selecting the screen to do the comparison on, you can alternate between the two prescriptions by clicking on the two grey boxes.
- 3 Ask the patient whether they see a difference when comparing the two values. (The patient should prefer the new refraction).

- 4 You can inform the patient that when you select the new refraction, this is how he/she will see with their new spectacles and that he/she should be able to see the improvement.

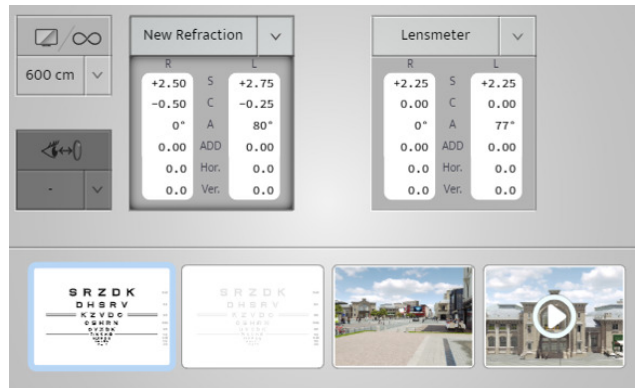

This is way we call it the “money button” >it converts your refraction into a sale by showing to the patient the difference he will see.

### a. Alert function in the comparison screen

The “Alert function” has been developed to assist the ECP to be aware if there are any significant changes from the patients' previous information. This auto alert function is an option, which can be activated and personalized in the [Setting] menu.

When activated, this alert will appear in red as shown in the image below.

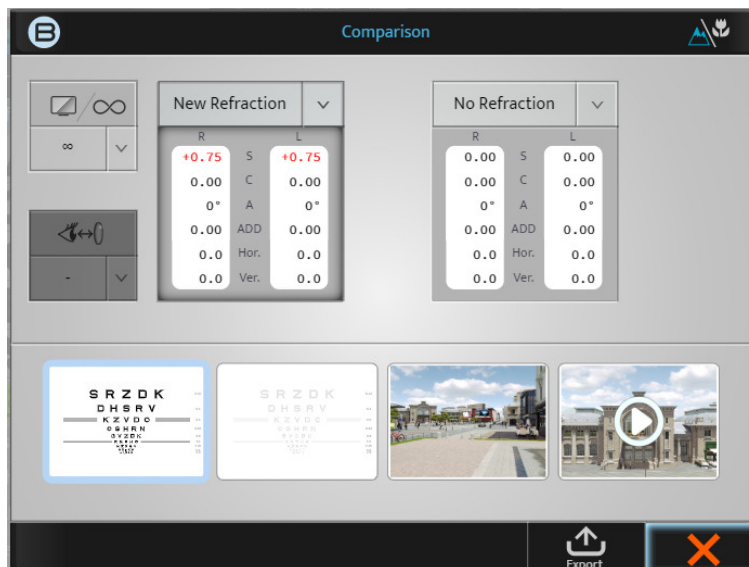

Note that this function can be activated, deactivated or personalized in the following [Setting] screen.

|                         | Data Format / Units | Distance             | Lens Step            |       |       |
|-------------------------|---------------------|----------------------|----------------------|-------|-------|
| Unit Distance           | cm                  | inch                 | diopter              |       |       |
| Far Exam Distance       | 600 cm              |                      |                      |       |       |
| Near Exam Distance      | 28 cm               | 33 cm                | 40 cm                | 50 cm | 67 cm |
| Vertex Distance         | 12 mm               | 13.75 mm             | 16 mm                | 18 mm | 20 mm |
| Comparison screen       | Infinity            |                      | Screen distance      |       |       |
| Comparison screen alert | None                | When $\Delta > 0.5D$ | When $\Delta > 1.0D$ |       |       |

When activated, the ECP can decide whether to see this “Alert” when the dioptric difference is greater than 0.50 D or when greater than 1.00 D.

## VIII. VERTEX DISTANCE MEASUREMENT





The “Vertex Distance” is the distance from the back side of a correcting ophthalmic lens (at the rear surface) to the patient's eye (at the apex of the cornea). The Vertex distance has always been of importance in refraction since the refraction value of an eye depends on the distance at which the corrective lens is located in front of the eye. Indeed, the further away the lens from the eye, the more minus the corrective power; the closer the lens to the eye, the more plus the power, whatever the ametropia.

### Measuring the Vertex distance could be very important

- If the patient is set up and tested at a different distance compared to the Vertex distance of the spectacles, the power change could have an effect on the performance of the spectacles.
- This is even more evident on higher powers

#### Measurement procedure

- 1 Ask the patient to position himself/herself behind the phoropter and rest their head against the forehead support while looking into the distance at the chart screen.
- 2 The practitioner checks that the phoropter is located close enough to the patient eye's, so as to offer a wide field of vision, but far enough to avoid the patient's eyelashes to be in contact with the back side window of the optical module.
- 3 The distance can easily be adjusted by using the rotating button located in front side of the Vision-R, turning it clockwise to reduce the Vertex distance and anti-clockwise to increase it.



- 4 The patient is then asked to look at distance and open the eyes widely. The practitioner press on the Vertex distance icon located at the top of the console screen.

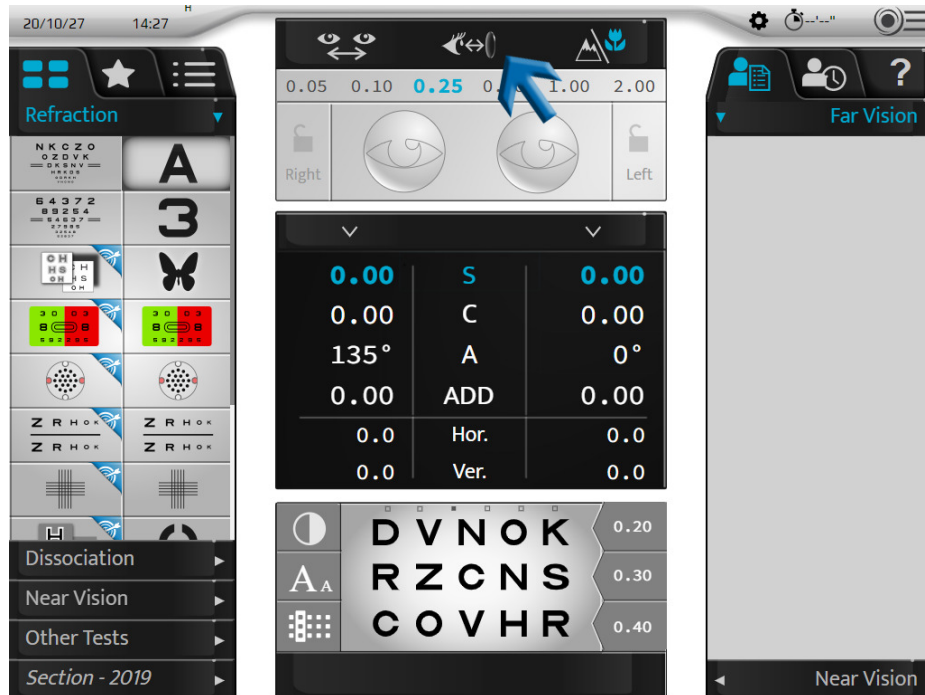

- 5 The two cameras capture images of the eyes which is displayed on the console.

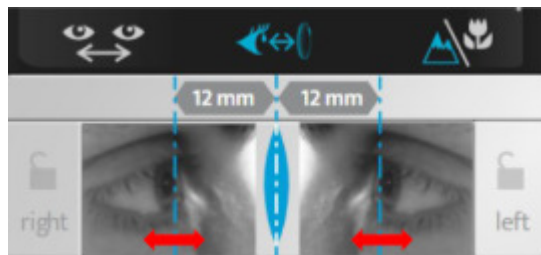

- > Two vertical lines appear on the images and the practitioner just has to align them with the apex of the cornea, either binocularly or minocularly.

On the console keyboard:

- o by turning the central button clockwise or counterclockwise, or

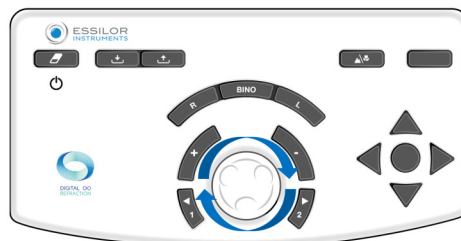

- o by pressing on the keys [+/-].

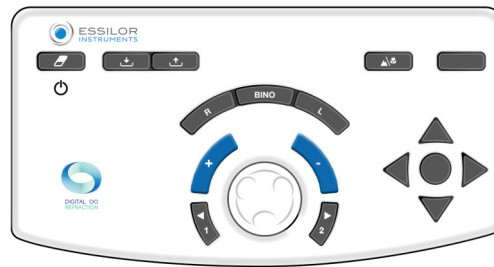

- > The value(s) of the Vertex distance(s) are automatically displayed and can then be recorded. A Vertex distance of 10 to 20 mm is appropriate.

## **IX. REFRACTION PROGRAMS**

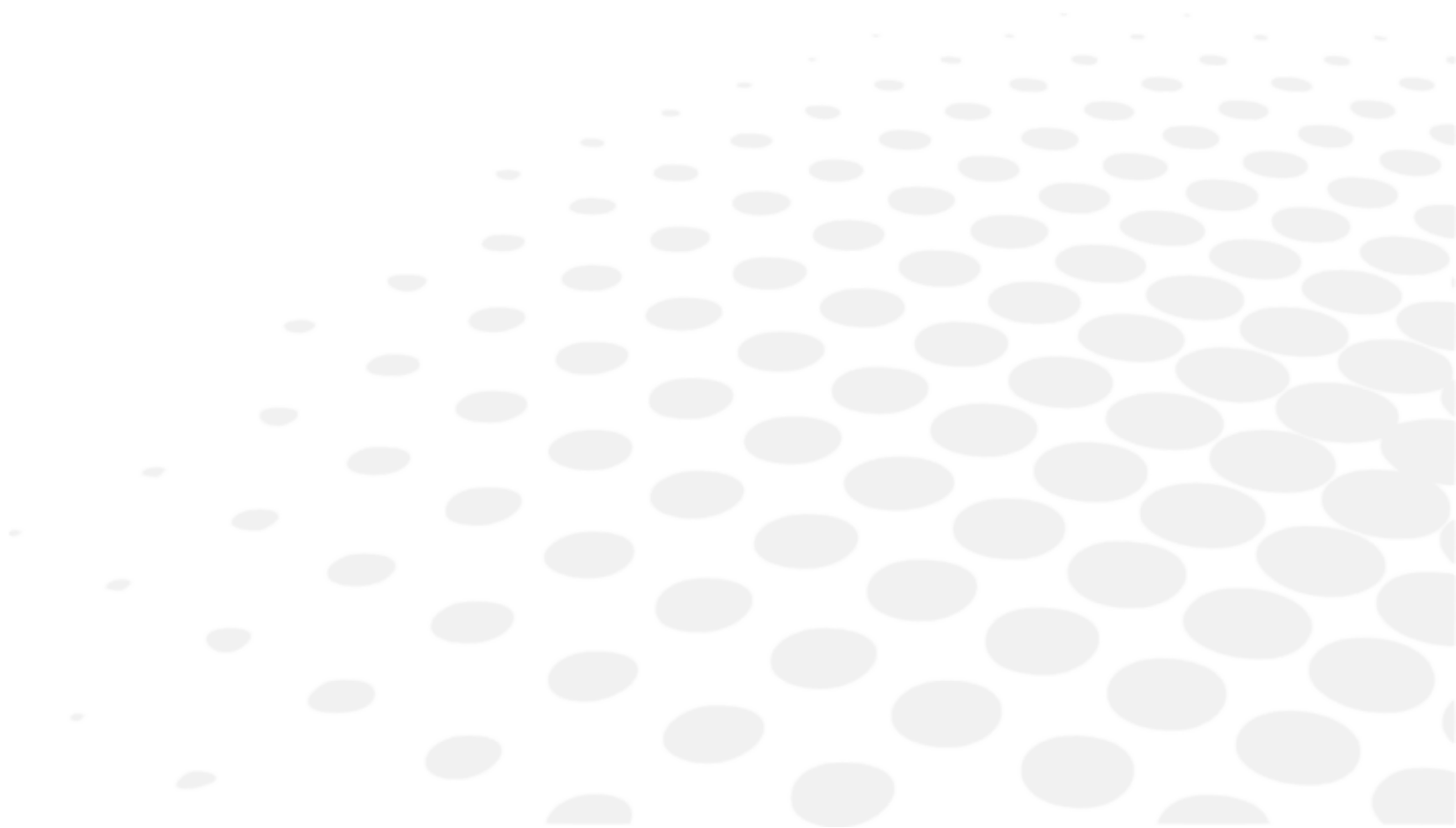

## 1. Standard programs

This section is not applicable.

## 2. Customized programs

### a. Editing and customizing programs and tests

#### Customize program

The Vision-R™800 allows you to personalize your test sequence (program).



Personalizing a program refers to the program itself and not the detail within the test.

- 1 Press on  > .

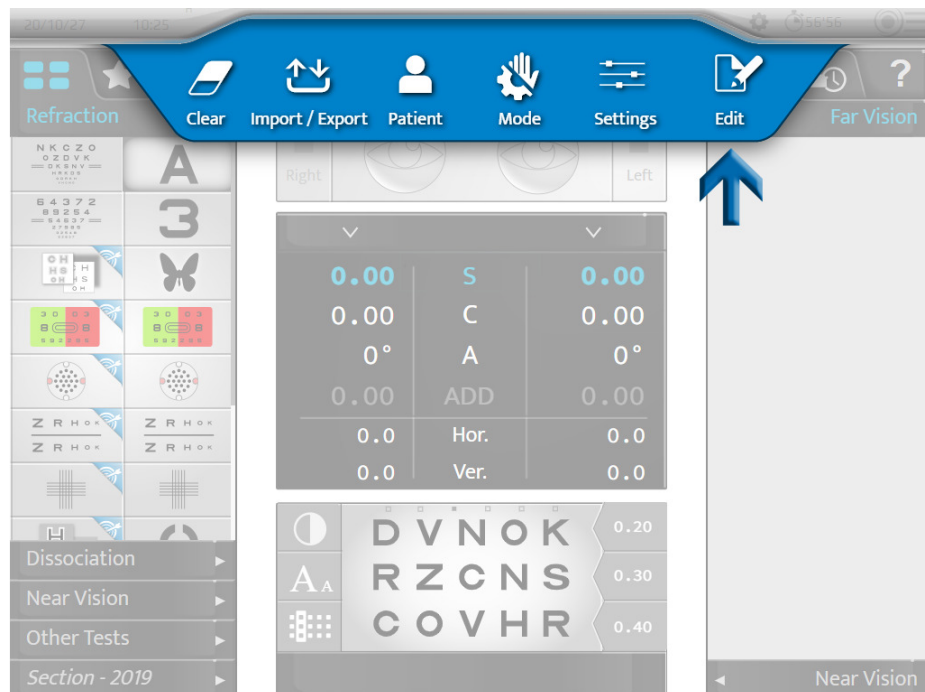

- 2 Click on  and click on [+] to create a new program.

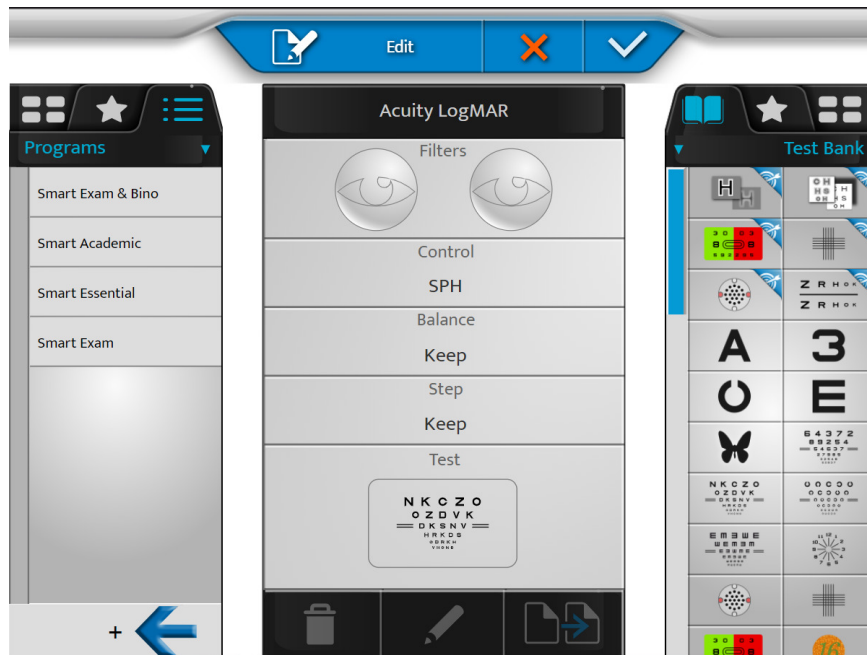

- > The following page appears:

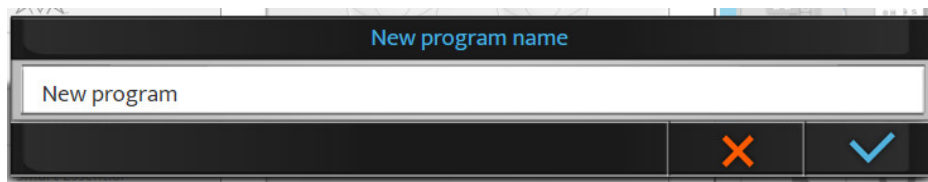

By default, the name is [New program]. At this stage, it is possible to modify the name of the program.



3 Name the program and click on .

> The new program appears in italics in the list of programs.

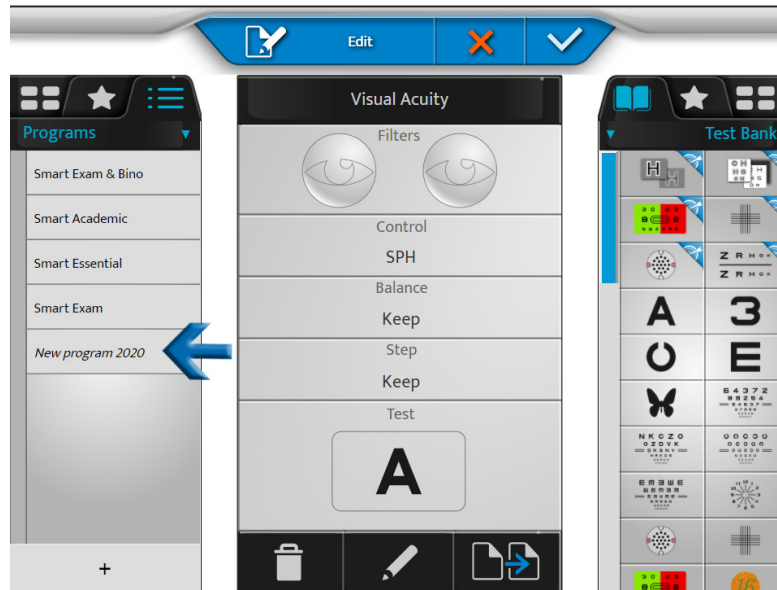

4 Click and hold on the name of the program to change its name or order in the list of program.

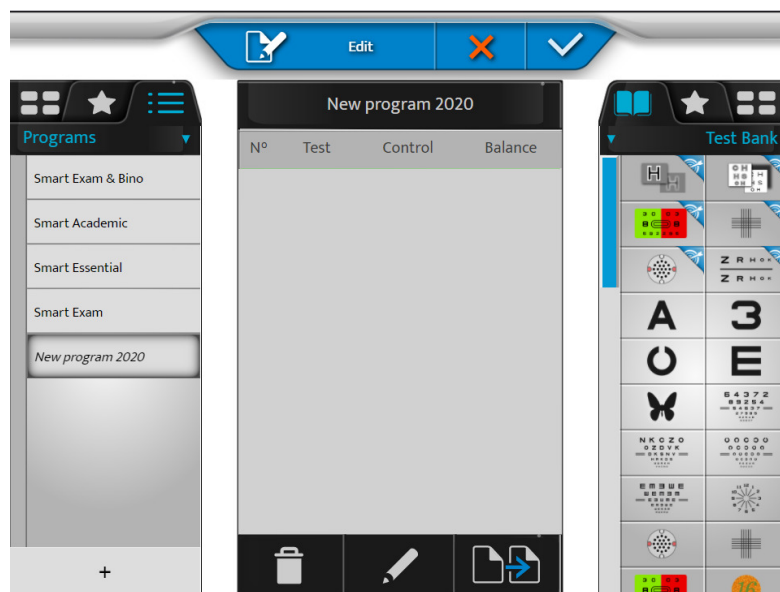

5 Click on  to edit the program.

> The list of tests appears in the right column.

- 6 Select a first test from the test bank, favorites or the library (by clicking on the corresponding tab at the top of the right column).

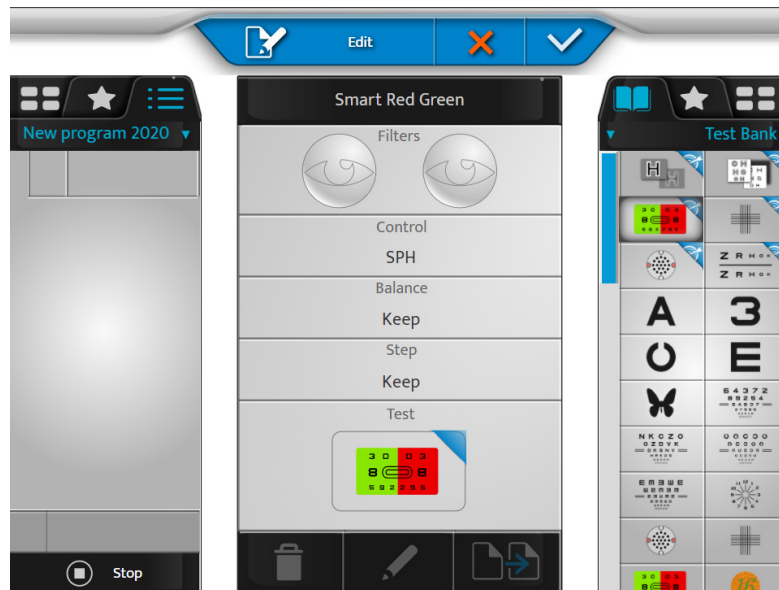

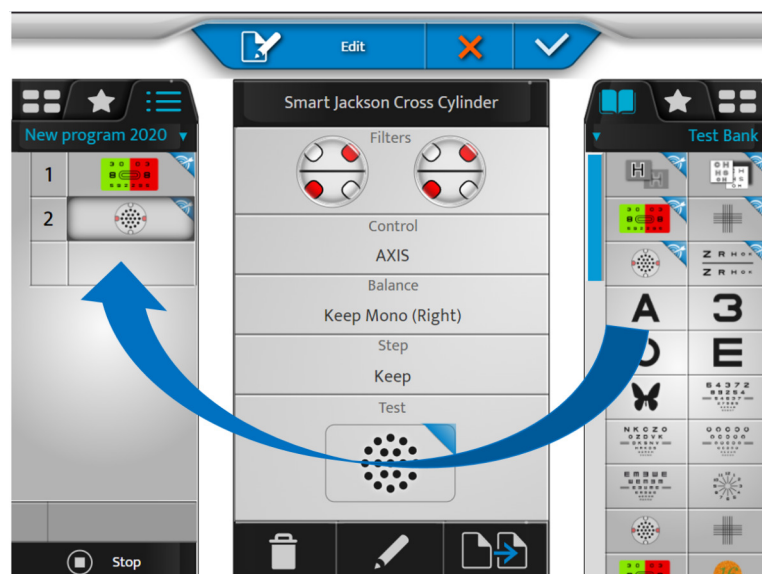

- o The test contents appear in the center block of the screen.
- o The contents of the program appear in the left section.

- 7 Click on the test and drag it and drop it in the program's test list (left column) in the intended location.



- 8 Do the same for the following tests to compose your program.

- 9 You can then click on:

- o  > to remove the selected test
- o  > to edit and change the test
- o  > to duplicate the program



> It is possible to change the order of the tests by dragging and dropping the list of tests in the program.

10 Click on  to validate the changes.



You can click on [Stop] to return to the list of programs, edit tests or favorites before you exit edit mode by validating with the key .

Customize test

The Vision-R™800 allows you to edit the specific test in great detail.

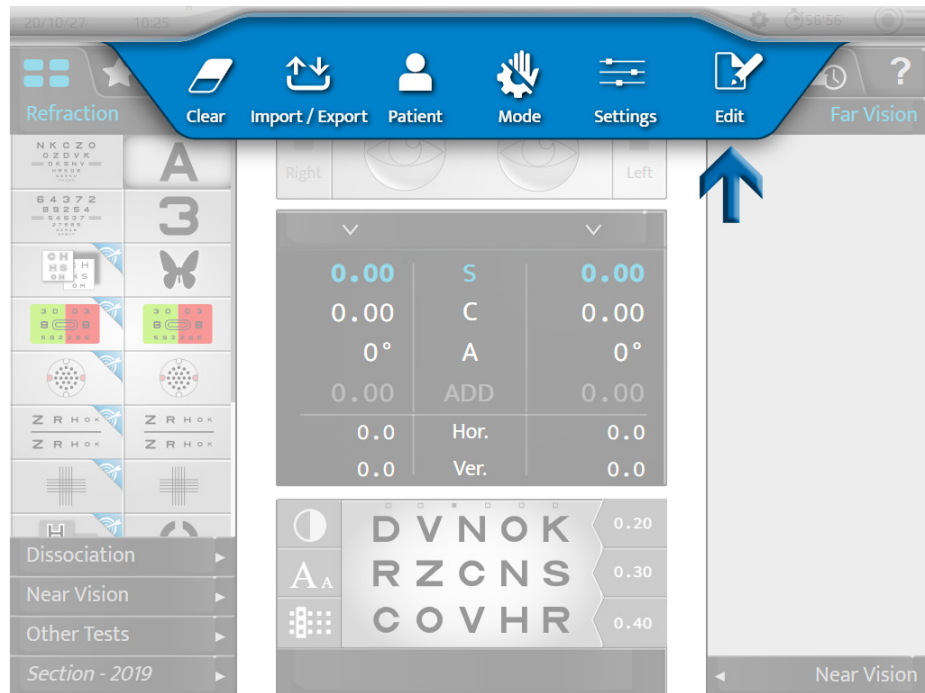

1 Press on  > .

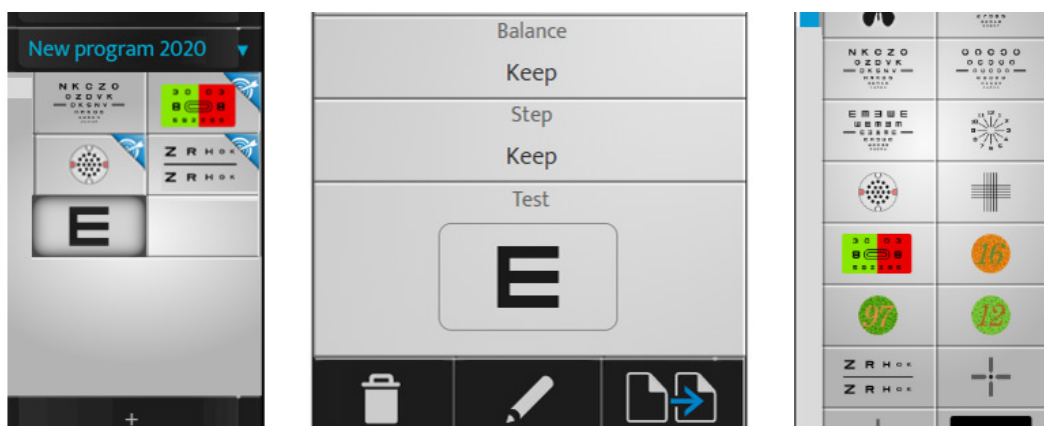

2 Select the test to customize (on the left column).



3 You can then click on:

- o  > to remove the selected test
- o  > to edit and change the test
- o  > to duplicate the test

> The following page appears:

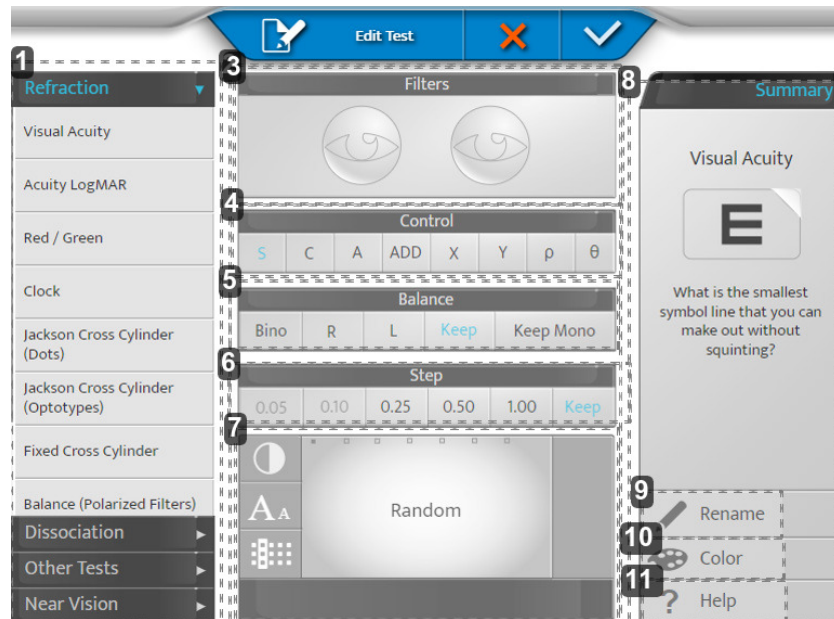

**1. Zone 1**

Set the test category and apply the default settings for that category.

**2. Zone 2**

Allows you to adjust the different settings of the test.

**3. [Filters]**

Allows you to view and select the filters placed in front of the patient's eyes (Red & Green, Maddox, Prisms, Stenopeic Holes, etc.) press long on the eyes.

**4. [Control]**

Allows you to choose the controlled optical parameter (Sphere, Cylinder, Axis, Addition, Prism components).

**5. [Balance]**

Allows you to choose the condition of the test (Bino, Right, Left, keep the previous condition, retain or impose the single-eye condition).

> [Keep Mono]: If the previous test is in binocular condition then the condition of the test is forced into monocular.

This setting is particularly recommended for astigmatism testing.

**6. [Step]**

Allows you to choose the power variation step (0.05, 0.10, 0.25, 0.50, 1.00 or kept the same as before).

**7. Display**

Allows you to view and change the display of the target presented during the test.

> For acuity boards: allows you to choose either random board selection (depending on the condition) or a particular board. And to define how it is presented (rows, columns, letters), its acuity level and the contrast or background.

**8. Zone 3**

Allows you to customize the test icon and test help.

**9. [Rename]**

Allows you to rename the test

**10. [Color]**

Allows you to change the color of the corner (top right) of the icon

**11. [Help]**

Allows you to change the text of the test help.

Don't forget to save by clicking on ✓.

**Example**

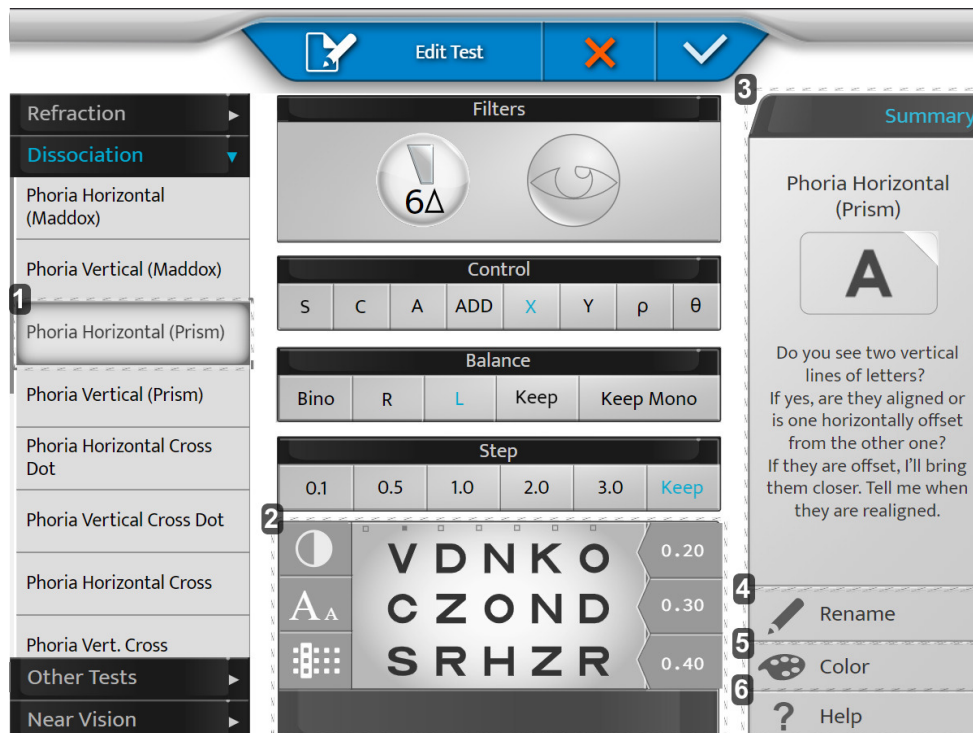

**1. [Phoria Horizontal (Prism)]**

By selecting a panel on the left it will assist with default settings (auxiliary lens change, prism activation, etc.)  
It is possible to override the suggested settings.

**2. [Display]**

Personalize your chart.

**3. [Summary]**

Help wording with each default test.

**4. [Rename]**

Name your test as you wish.

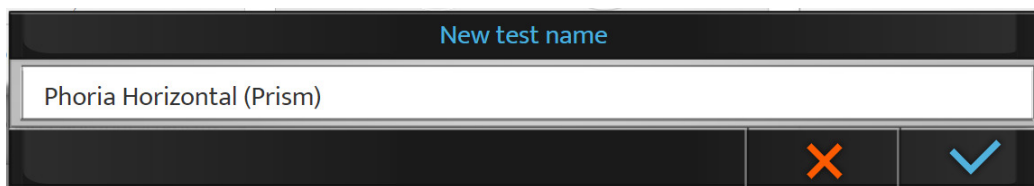

**5. [Color]**

Choose your color for recognition.

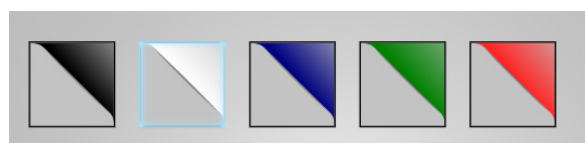

6. [Help]

Write your own speech to use during test (help button).

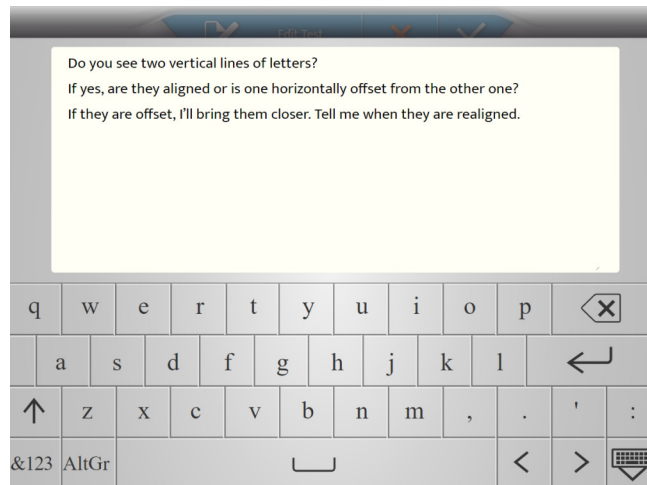

**b. Favorite tests selection**

The Vision-R™800 allows you to add favorite test.

- 1 Click on the [Favorites] tab in the left column.

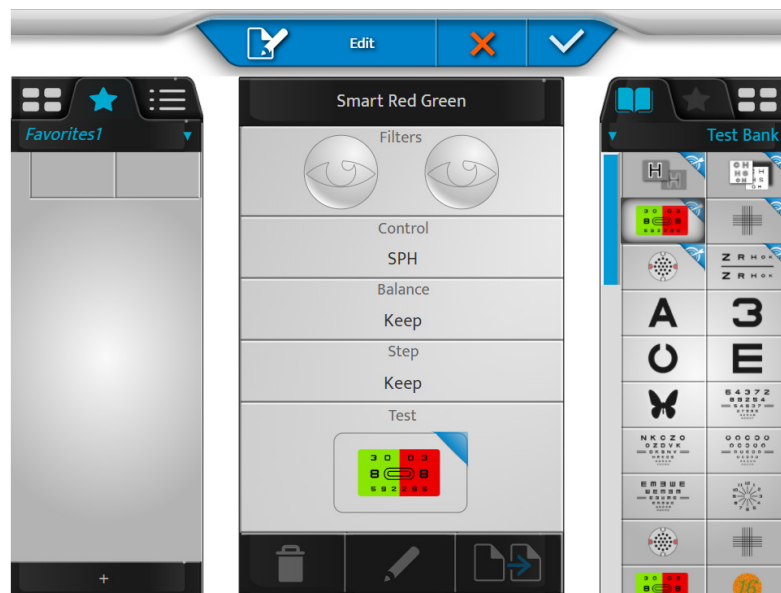

- 2 Select a first test from the test bank or library (by clicking on the corresponding tab at the top of the right column).

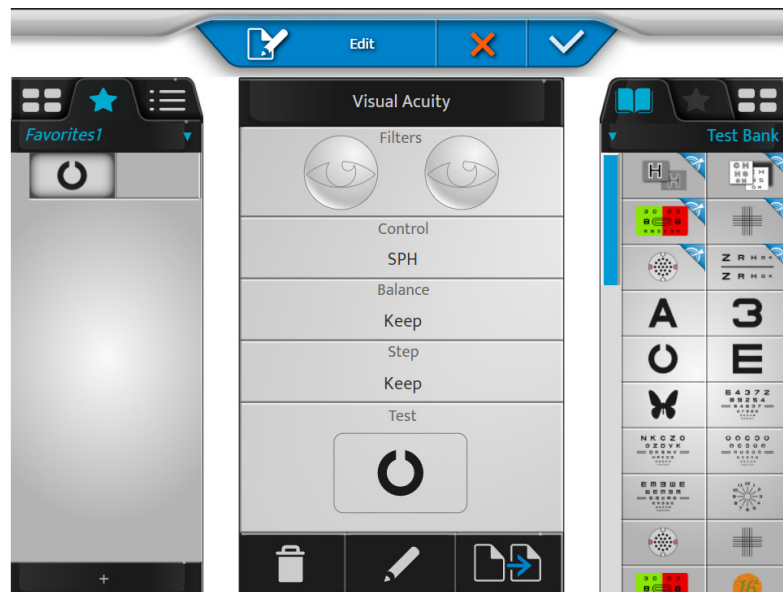

- 3 Click on the test, drag it and drop it in the favorite test section (left column) at the intended location.

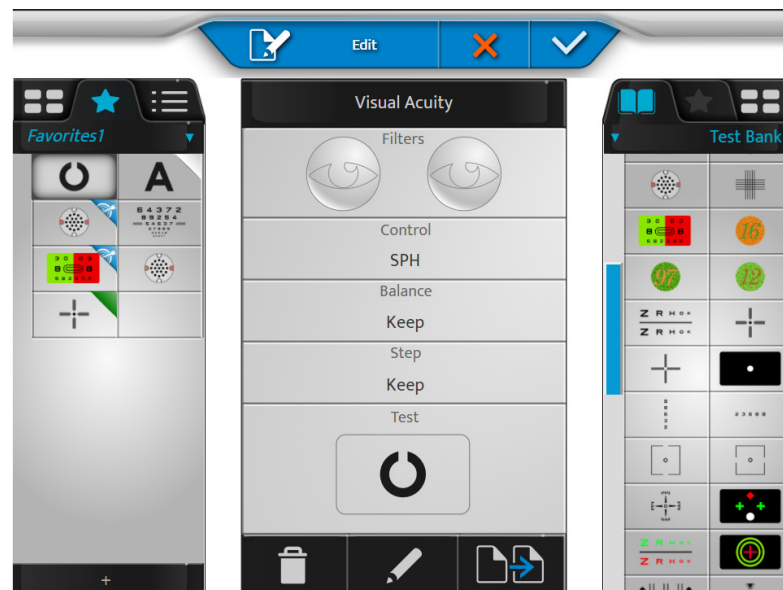

- 4 Do the same for the following tests.



- 5 You can then click on:

-  > to remove the selected test
-  > to edit and change the test
-  > to duplicate the favorite



> You can change the order of the tests by dragging and dropping in the test section.

- 6 Click on [+] to create a new favorite test section.



- > The following page appears:

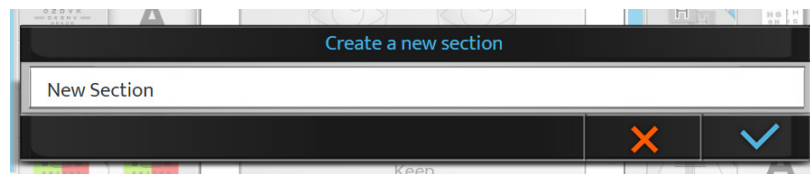

- 7 Click on:
- o ✓ to confirm
  - o ✗ to cancel
- 8 Click and hold on the name of the favorite to change its name or order in the list of favorites.

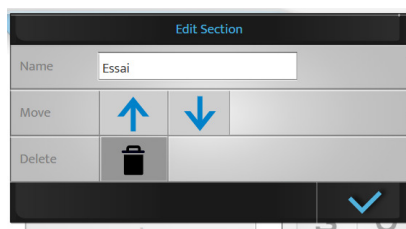

You can remove the created program by pressing .



- 9 Finally, click on:
- o ✓ to confirm
  - o ✗ to cancel



A favorite test section can be removed if more than one section is present. If only one section is present, it cannot be removed.

## **X. INSTRUMENT SETTINGS**



It is possible to modify the default settings of the instrument by pressing on  > .

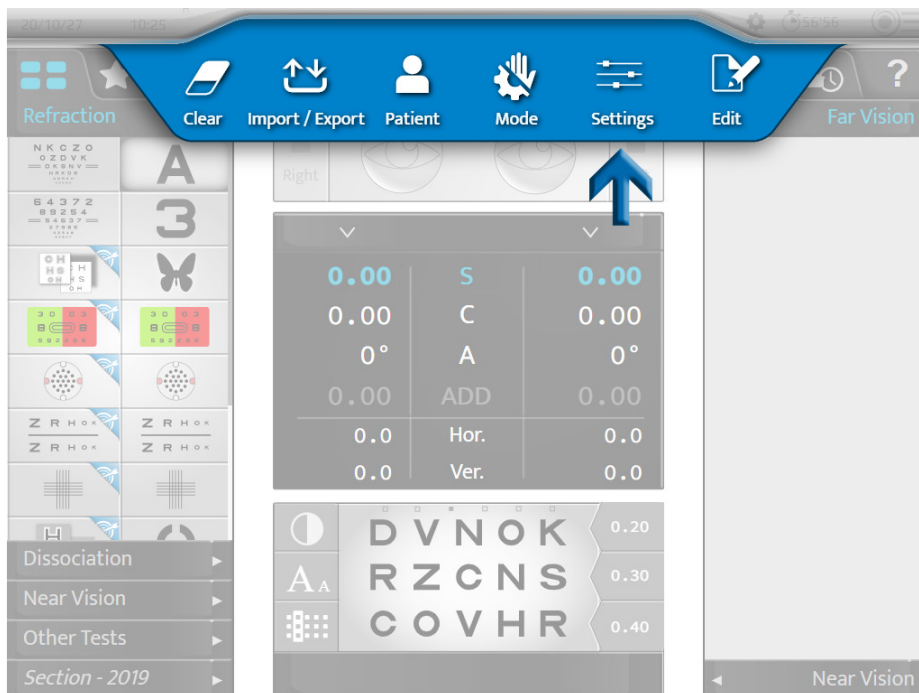

> The instrument settings page is displayed.

## 1. General information

The general information menu has two pages:

1. [General]
2. [Devices]

### 1 - Page [General]

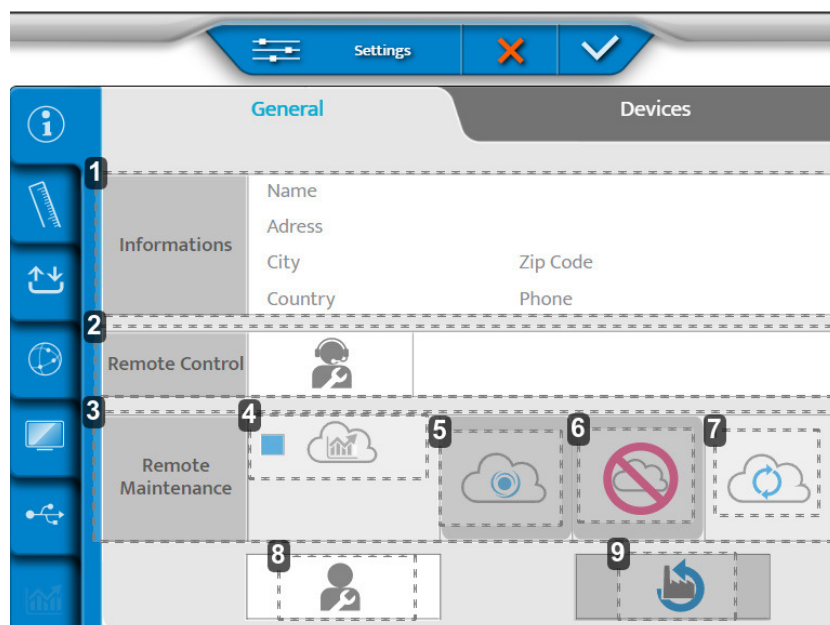

#### 1. [Informations]

Customer's information

2. *[Remote Control]*  
Remote access,
3. *[Remote Maintenance]*  
Access to the remote maintenance
4. *Access to the statistics and the log files*
5. *Recording on SIS*
6. *Deletion of recording*
7. *Connection refreshing*
8. *After-sales service*
9. *Restoration of the factory default settings*

**2 - Page [Devices]**

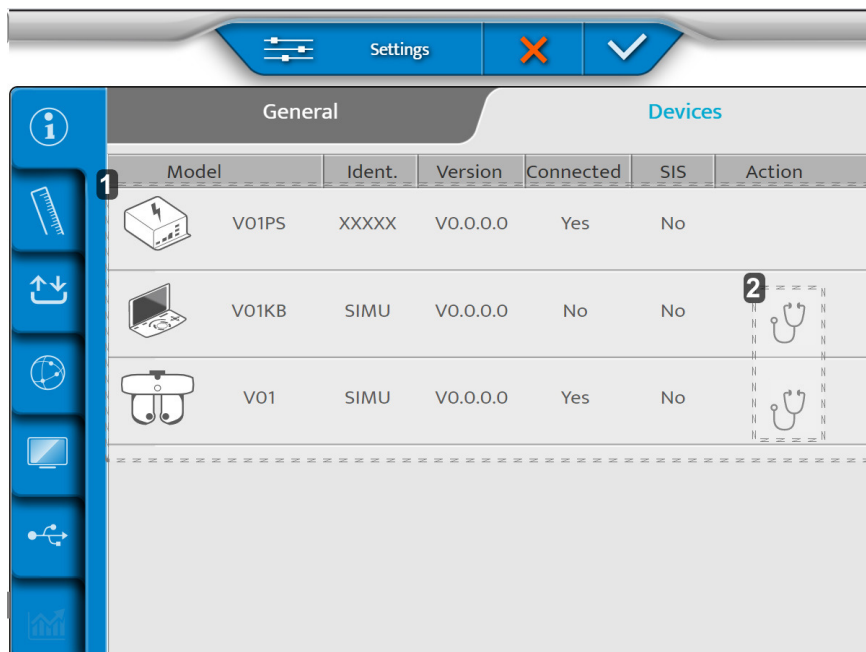

1. *Information concerning the various components of the instrument*
2. *Carry out autotests*

Once the adjustments are made, press on:

- to confirm.
- to cancel.

### Carrying out the autotests of the phoptor head

1 On the [Device] page, press on .

> The following page appears:

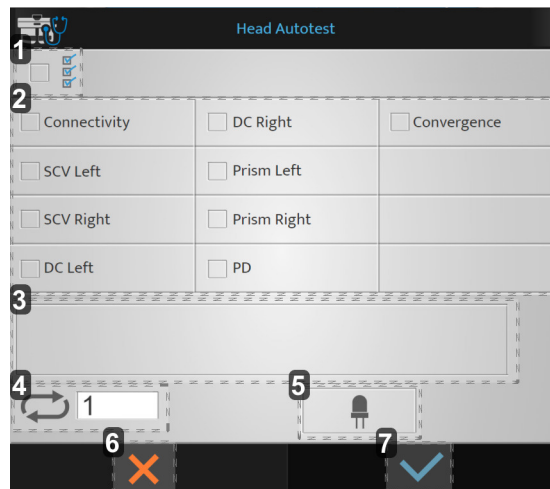

1. Launch of all the self-tests
2. List of available self-tests
3. Display
4. Number of self-test launch
5. Test of LEDs in near-vision mode
6. Launch cancellation
7. Launch confirmation

2 Choose the autotests which you wish to perform and press on .

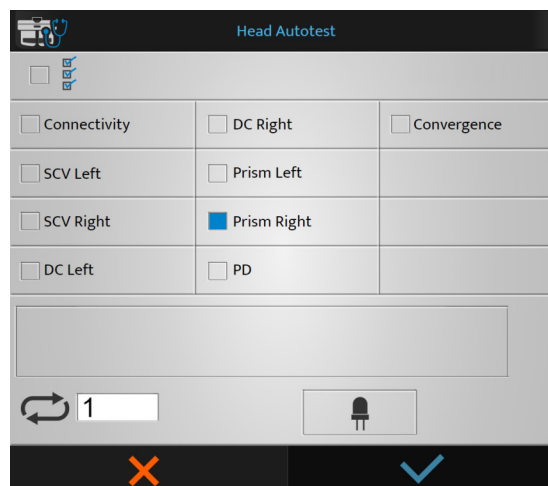

> The autotests starts.

### Carrying out the autotests of the console

- 1 On the [Device] page, press on .
  - > The following page appears:



1. *Test of the speaker*



If you press a button on the console, then the buttons are displayed in blue.

- 2 Choose the autotests which you wish to perform and press on .
  - > The autotests starts.

## 2. Measurement data

The measurement data menu has three pages:

1. [Dated Format/Units]
2. [Distance]
3. [Lens Step]

### 1 - Page [Data Format / Units]

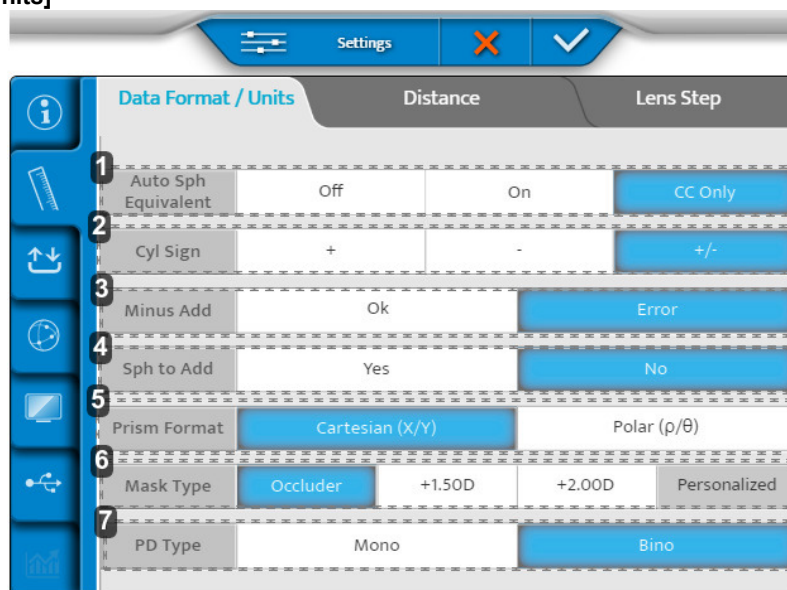

1. [Auto Sph Equivalent]

Automatic maintenance of the equivalent sphere during a refraction process.

2. [C Sign]

Define the sign of the cylindrical power (C).

3. [Minus ADD]

Allows for the addition of a negative value.

- o OK: authorizes the negative addition for specific tests
- o Error: only a positive addition can be taken into account

4. [Sph to Add]

Allows user to combine or separate the addition of the near vision from/to the far-vision sphere.

5. [Prism format]

6. [Mask type]

The choice of the type of mask during a test in monocular vision.

7. [PD type]

Define the default settings of monocular or binocular pupillary distance.

2 - Page [Distance]

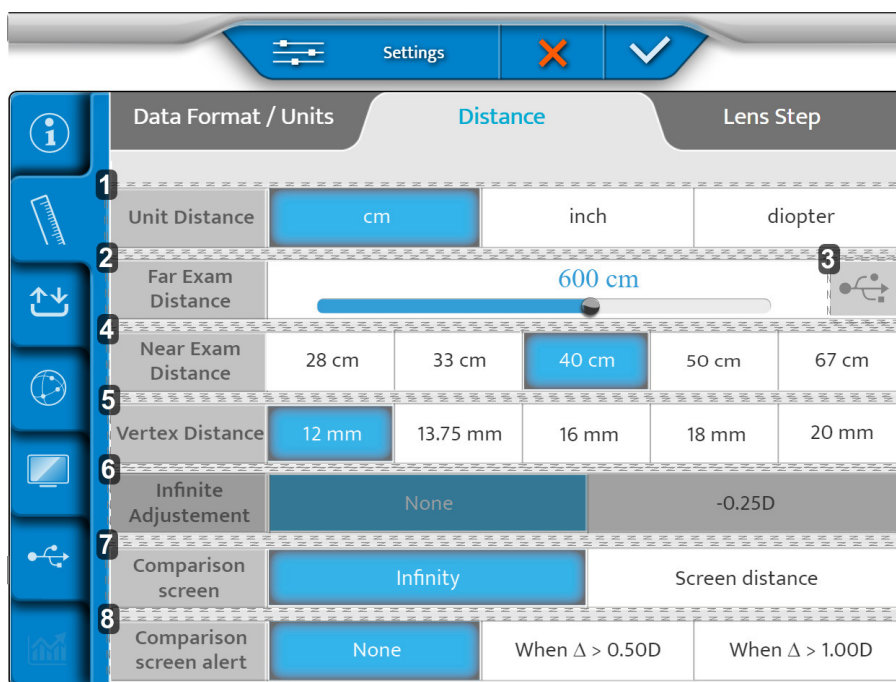

1. [Unit distance]

Define the default distance unit:

- o in cm
- o in inches
- o in diopters

2. [Far exam distance]

Define the test presentation screen distance.

To modify this distance move the cursor to the left or the right (steps from 25 cm from 3m to 8m).

3. Generation of personalized optotypes

4. [Near exam distance]

Defines the distance of the near-vision test.

> The values indicated correspond to a default setting in cm.

5. [Vertex Distance] (in mm)

Sets the Vertex distance by default taken into account for the conversion of the refraction value of a standard reference distance.

6. [Infinite Adjustments]

Conversion to "infinite". None or a fix value.

7. [Comparison Screen]

Default setting on comparison screen.

8. [Comparison Screen Alert]

Alert ECP if the difference is higher than selected value. (Value to appear in red in Bluetouch).

3 - Page [Lens step]

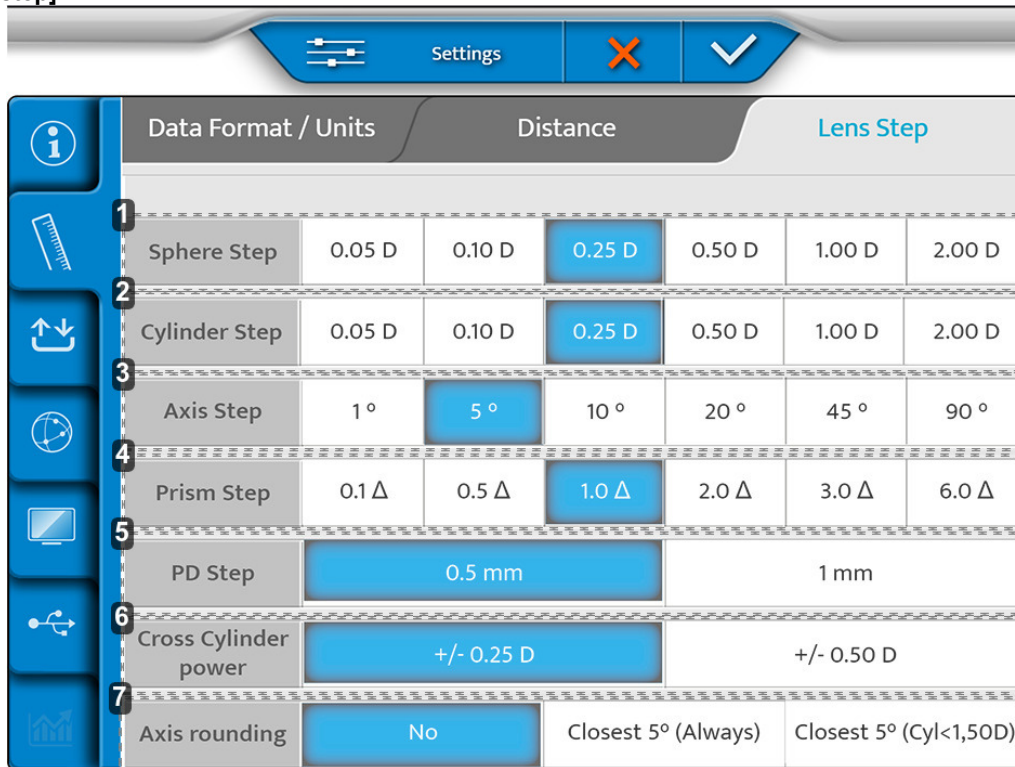

1. [Spherical Step]

Define the default variation step of the sphere.

2. [Cylinder Step]

Define the default variation step of the cylinder.

3. [Axis Step]

Define the default variation step of the axis.

4. [Prism Step]

Define the default variation step of the prism.

5. [PD Step]

Define the default variation step of the pupillary distance.

6. [Cross Cylinder power]

Sets the default value of the cross cylinder, used for finding the cylinder in manual mode.

7. [Axis rounding]

xx

Once the adjustments are made, press on:

-  to confirm.
-  to cancel.

### 3. Import/Export data

The Import/export menu has three pages:

1. Import/export
2. Memory
3. Default Export

#### 1 - Page [Import / Export]

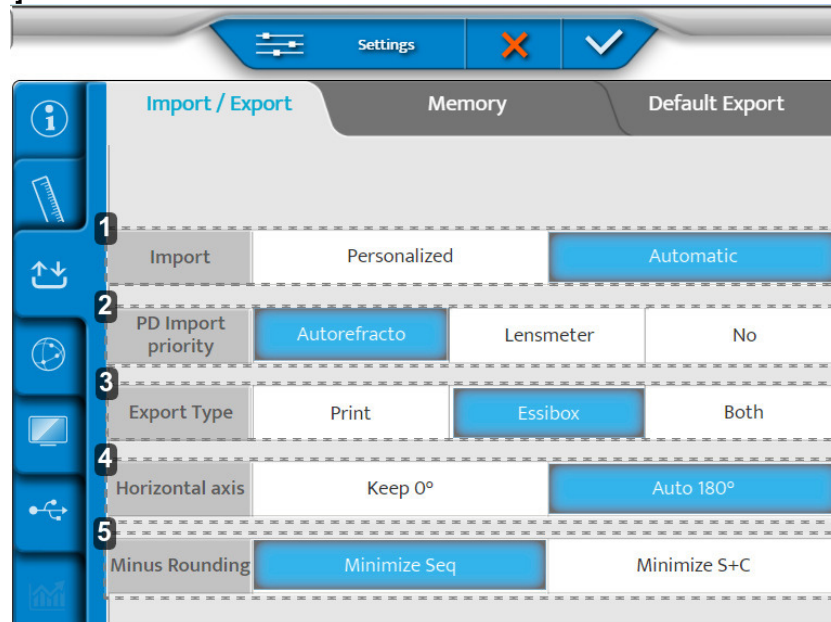

#### 1. [Import]

Describe the type of importing:

- o Manual
- o Automatic

#### 2. [PD Import Priority]

Determining which import from which instrument gets priority to be inserted in phoropter.

#### 3. [Export Type]

Defines the way data is processed during export:

- o Sent to the printer
- o Sent to the Essibox
- o Both

#### 4. [Horizontal axis]

Selecting default value of either 0 or 180°.

#### 5. [Minus Rounding]

Selecting the minus rounding.

## 2 - Page [Memory]

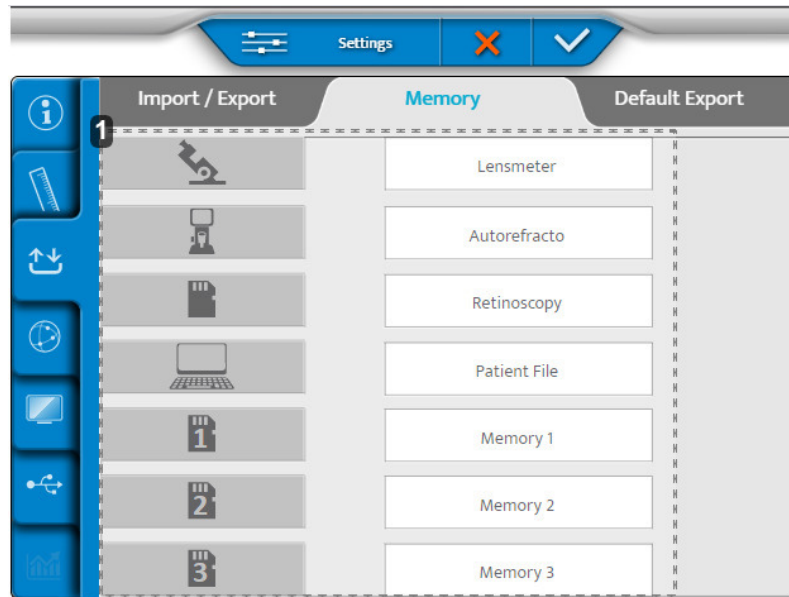

1. List of available memories

## 3 - Page [Default Export]

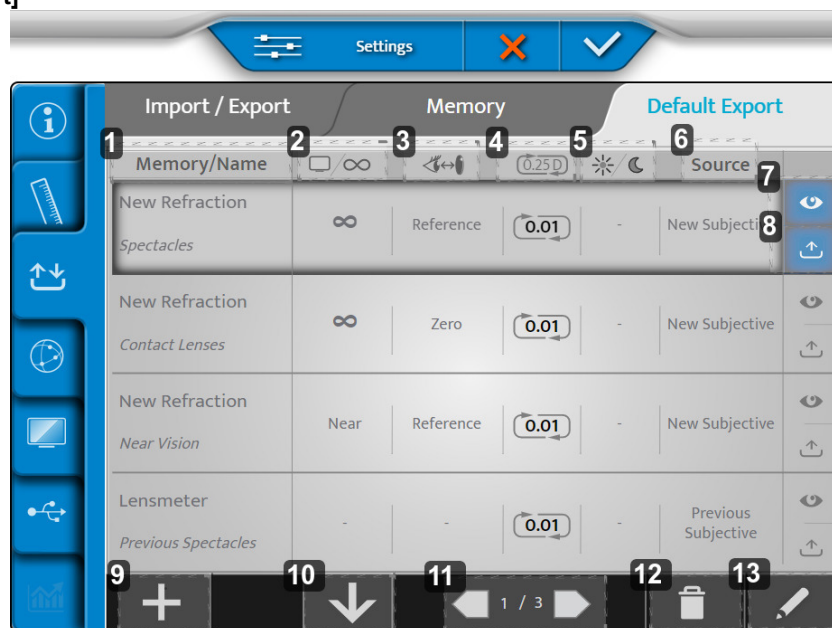

1. [Memory/Name]  
Indicates the memory to be exported and the name of the corresponding data type.
2. Screen distance  
Indicates the distance for which the correction is exported.
3. Vertex distance  
Indicates the vertex distance for which the correction is exported.
4. Rounding  
Indicates the correction step and its possible rounding type.
5. Day/night vision  
Indicates the conditions under which the test is performed, day or night.
6. [Source]  
Label the data type according to the source.

**7. Display**

View the default exported data display.

**8. Export**

Export the data by default.

**9. More**

Add a new data type to the export configuration.

**10. Organize**

Organize the order of the data types to be exported.

**11. Pagination**

Navigate through the different pages of the export configuration.

**12. Waste bin**

Remove an export data type.

**13. Pen**

Edit and change an export data type.

**1** To edit and change an export data type, click on .

> The following page appears:

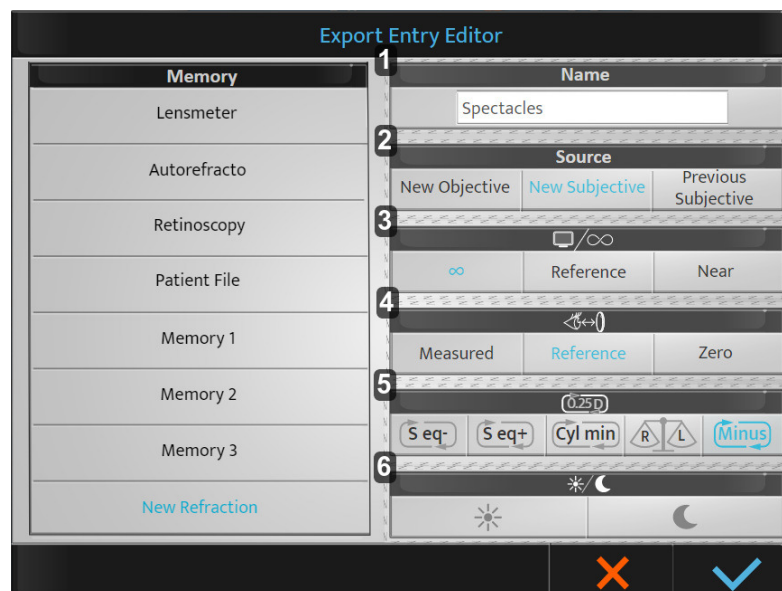

**1. [Name]**

Specifies the name of the export data type and allows you to change it.

**2. [Source]**

Indicates the source label:

- [New Objective]: new objective > measured objective refraction.
- [New Subjective]: new subjective > determined subjective refraction.
- [Previous Subjective]: old subjective > Previous subjective refraction (old correction).

**3. Screen distance**

Specifies the distance for which the correction is exported:

- Infinite: correction carried over ad infinitum (-1/D added)\*.
- [Reference]: reference > far vision screen distance correction (D)\*
- [Near]: close > near vision distance correction (chosen at phoropter settings).

\*: with D = screen distance configured during phoropter installation.

#### 4. Vertex distance

Indicates the vertex distance for which the correction is exported:

- [Measured]: measured > keeps the measured vertex distance during the refraction.
- [Reference]: reference > Adjusts the correction to the vertex distance selected during the phoropter settings.
- [Zero]: Zero > Adjust the correction to 0 mm vertex distance (contact lenses).

#### 5. Rounding

Indicates the type of rounding you want



- [S eq-]: rounded to concave
- [S eq +]: rounded to convex
- [ Cyl min]: cylinder thinning
- [ R/L]: binocular balance compliance

If no selection is made, the 0.25D rounding step is done. The retained value is 0.01D.

#### 6. Day/night vision

- Day: refraction under photopic light conditions.
- Night: refraction under mesopic/scotopic light conditions.

2 Make the desired adjustments and click on:

-  to confirm
-  to cancel

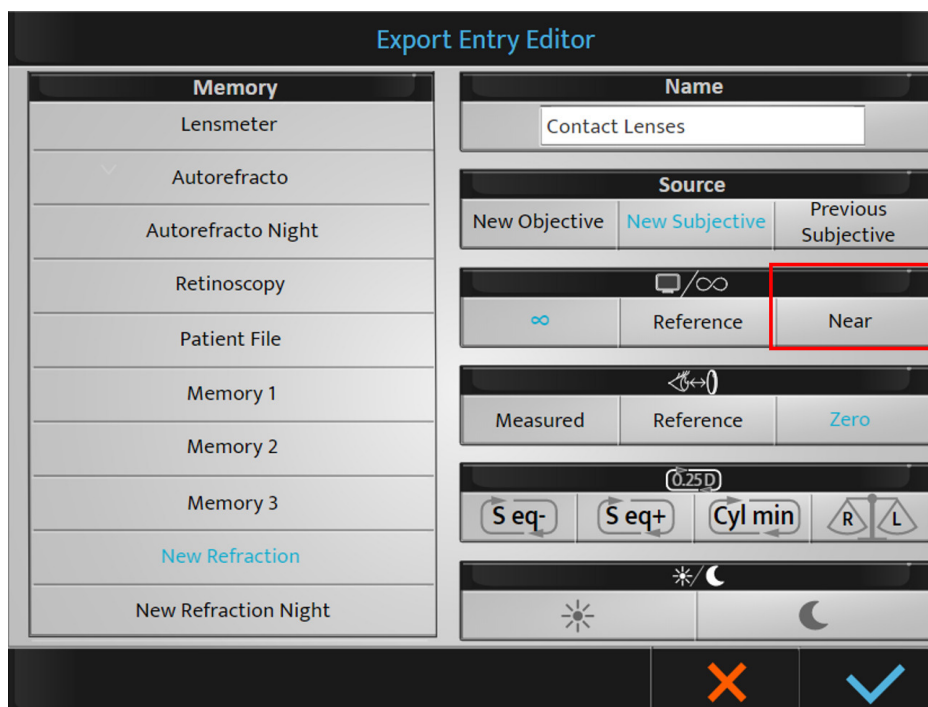

When selecting the screen distance [Near], the value of the addition will automatically be added to the value of the sphere of far vision (to obtain the near vision correction).

Once the default settings are saved, they will be available during export. It is always possible to modify them at the end of the examination if necessary.



It is possible to rename the memories (long press on name).

Once the adjustments are made, press on:

- ✓ to confirm.
- ✗ to cancel.

## 4. Communication settings

The element settings menu consists of three pages:

- Chart
- IP
- Essibox.com

### 1 - Page [Chart]

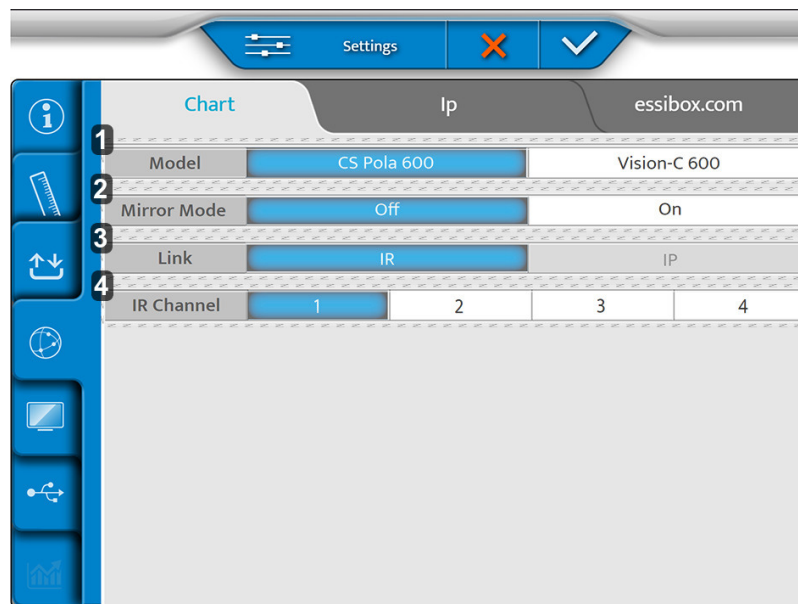

1. [Model]  
xxx
2. [Mirror Mode]  
Mirror Mode Activation (according to configuration)
3. [Link]
4. [IR Channel]  
Used during set up of chart system for communication

2 - Page [Ip]

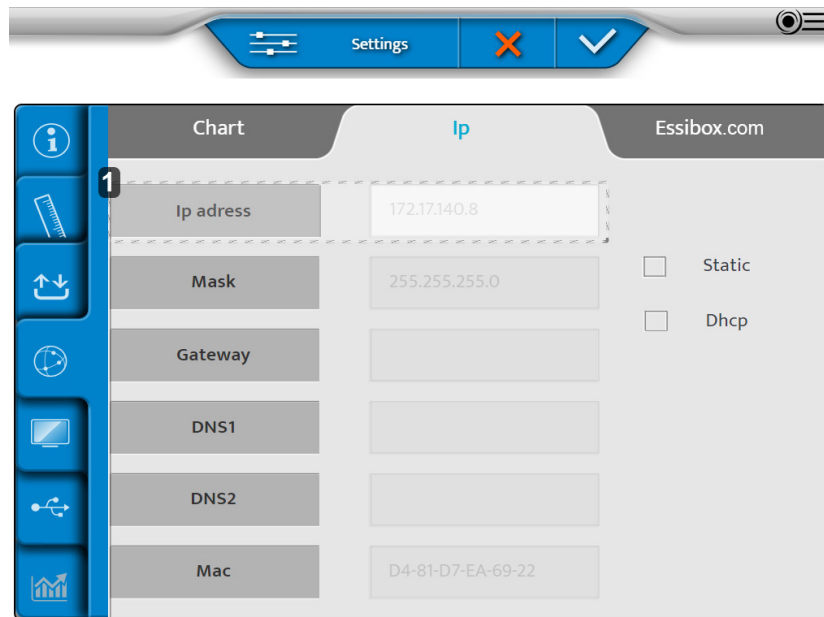

1. [Ip address]

Can be [Static] or [Dhcp]

3 - Page [Essibox.com]

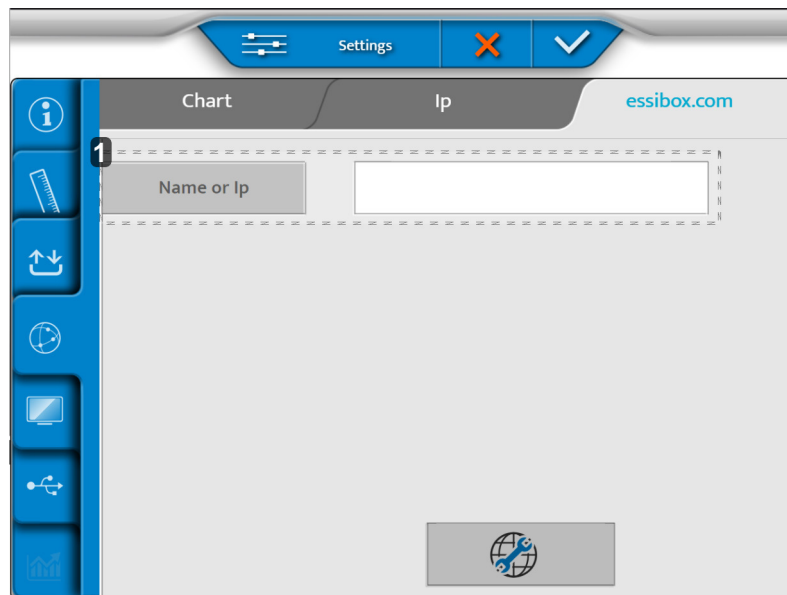

1. [Name or Ip]

Name or Ip of the Cbox that must be set up.

Once the adjustments are made, press on:

-  to confirm.
-  to cancel.

## 5. Local settings

The local settings menu consists of three pages:

- Chart Display
- Keyboard Settings
- Regional Settings

### 1 - Page [Chart Display]

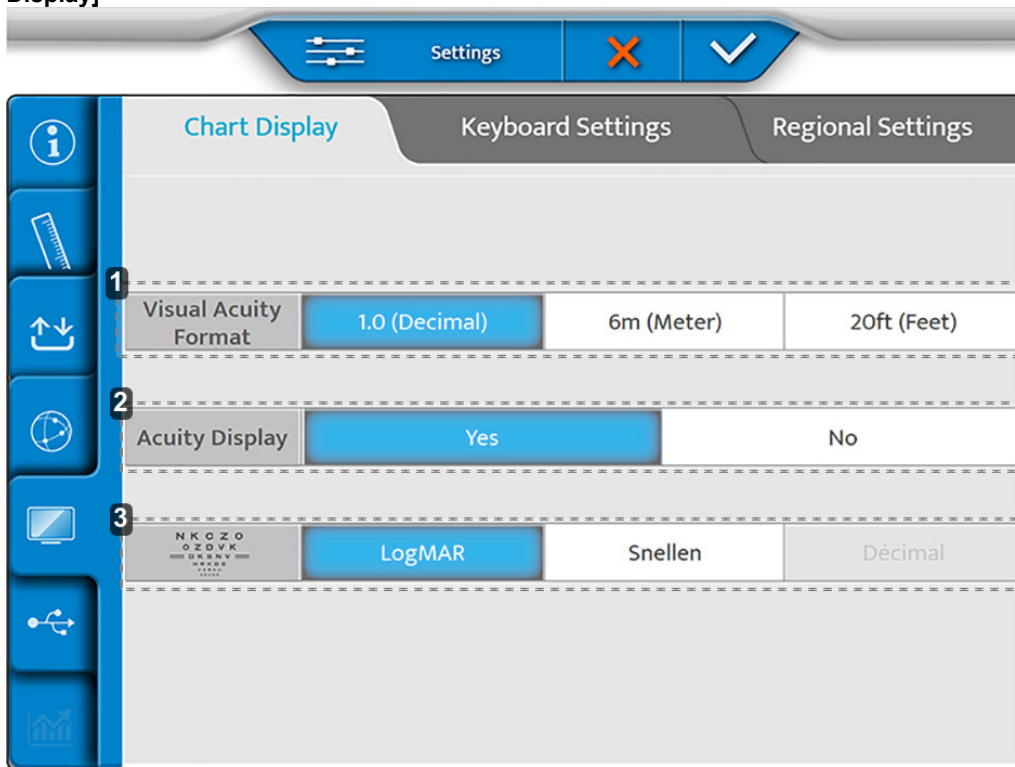

1. [Visual acuity format]  
Define the visual acuity format depending on local usage.
2. [Acuity Display]  
xx
3. ETDRS progression  
Configuration of the ETDRS progression : logMar or Snellen.

## 2 - Page [Keyboard Settings]

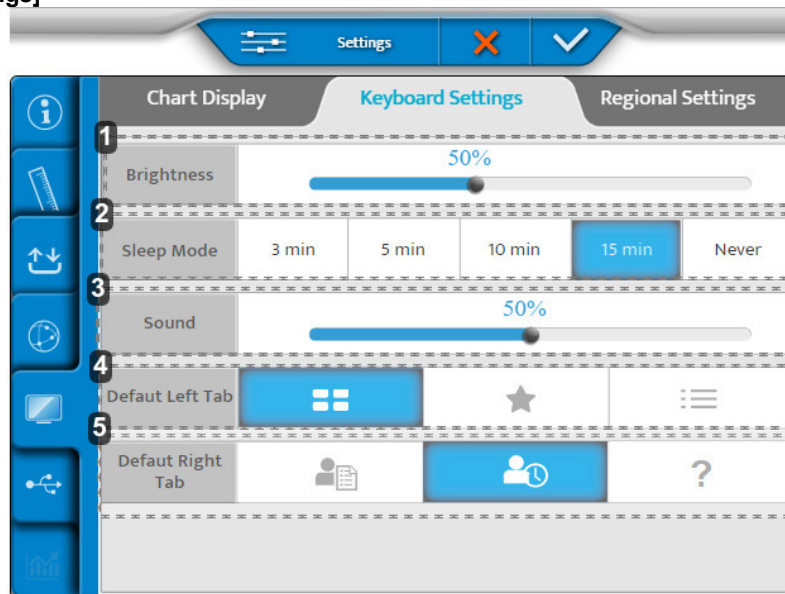

1. **[Brightness]**  
Sets the console screen brightness level
2. **[Sleep Mode]**  
Sets console sleep time
3. **[Sound]**  
Sets the sound level of the console screen
4. **[Default Left Tab]**  
Sets the default display on the left side of the console screen
5. **[Default Right Tab]**  
Sets the default display on the right side of the console screen

## 3 - Page [Regional Settings]

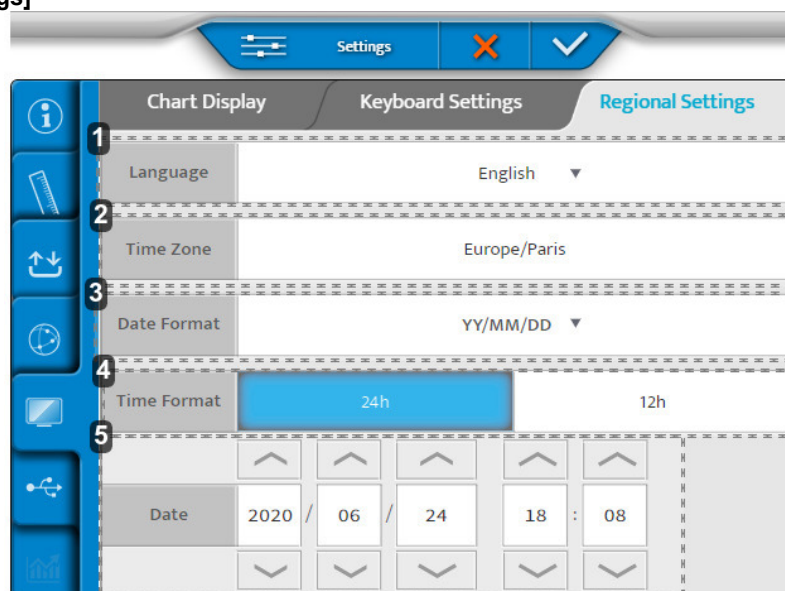

1. **[Language]**  
Sets the display of the console language
2. **[Time Zone]**  
Sets the display of the console time zone

### 3. [Date Format]

Sets the display of the console date format:

- Year/Month/Date > [YY/MM/DD]
- Month/Date/Year > [MM/DD/YY]
- Date/Month/Year > [DD/MM/YY]

### 4. [Time Format]

Sets the display of the console time format

### 5. [Date]

Sets the display of the console date format

Once the adjustments are made, press on:

-  to confirm.
-  to cancel.

## 6. Backups restore

The backups restore menu has two pages:

1. Backup
2. Restore

### 1 - Page [Backup]

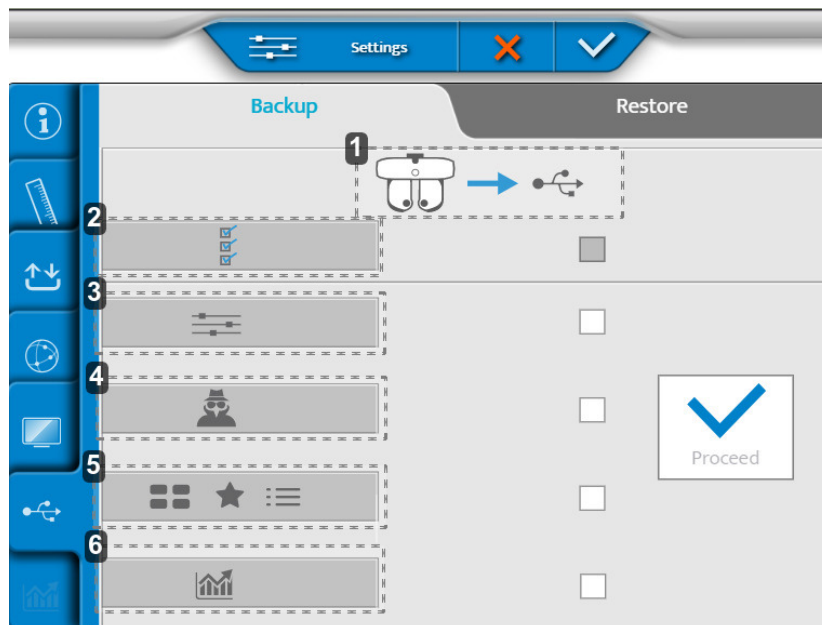

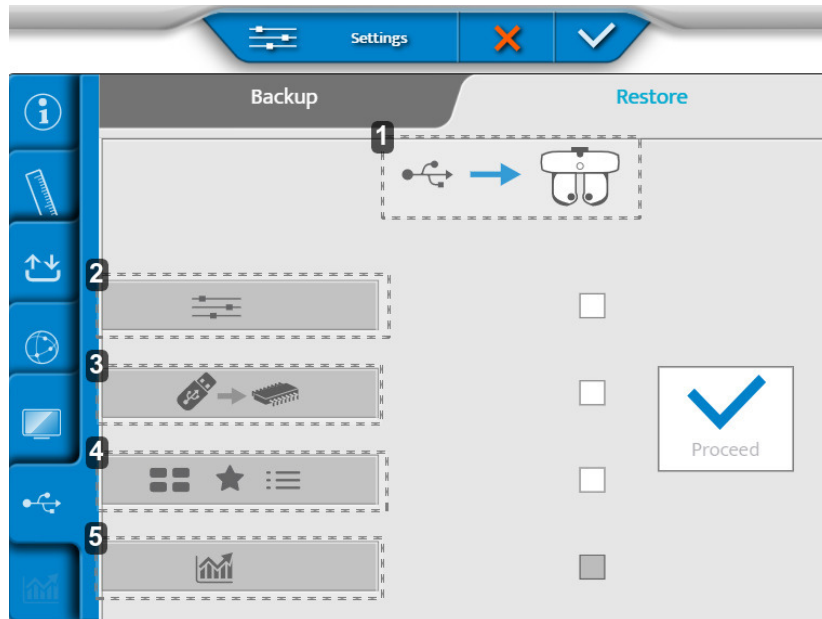

1. Export of refraction head data to an USB key
2. Export of all the instrument data
3. Settings export
4. Export of the technician data
5. Export of tests, favorites and test programs
6. Statistics exportation

**2 - Page [Restore]**



1. *Importing of data from an USB key to the refraction head*
2. *Settings importing*
3. *Importing a memory update*
4. *Importing new tests, favorites and test programs*
5. *Statistics importing*

Once the adjustments are made, press on:

-  to confirm.
-  to cancel.

# XI. ERROR DISPLAY

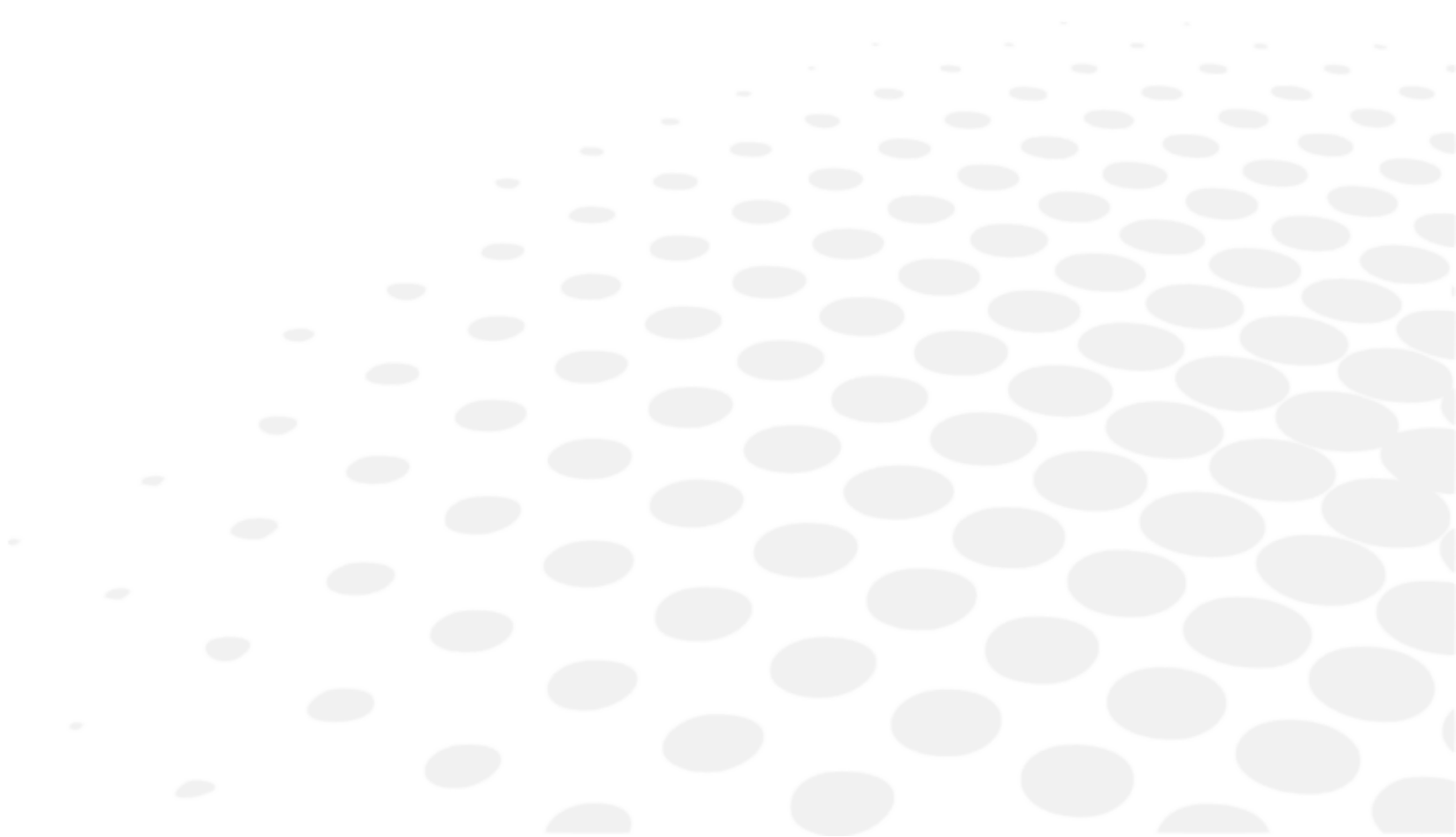

This section is not applicable.

# XII. SAFETY CONSIDERATION

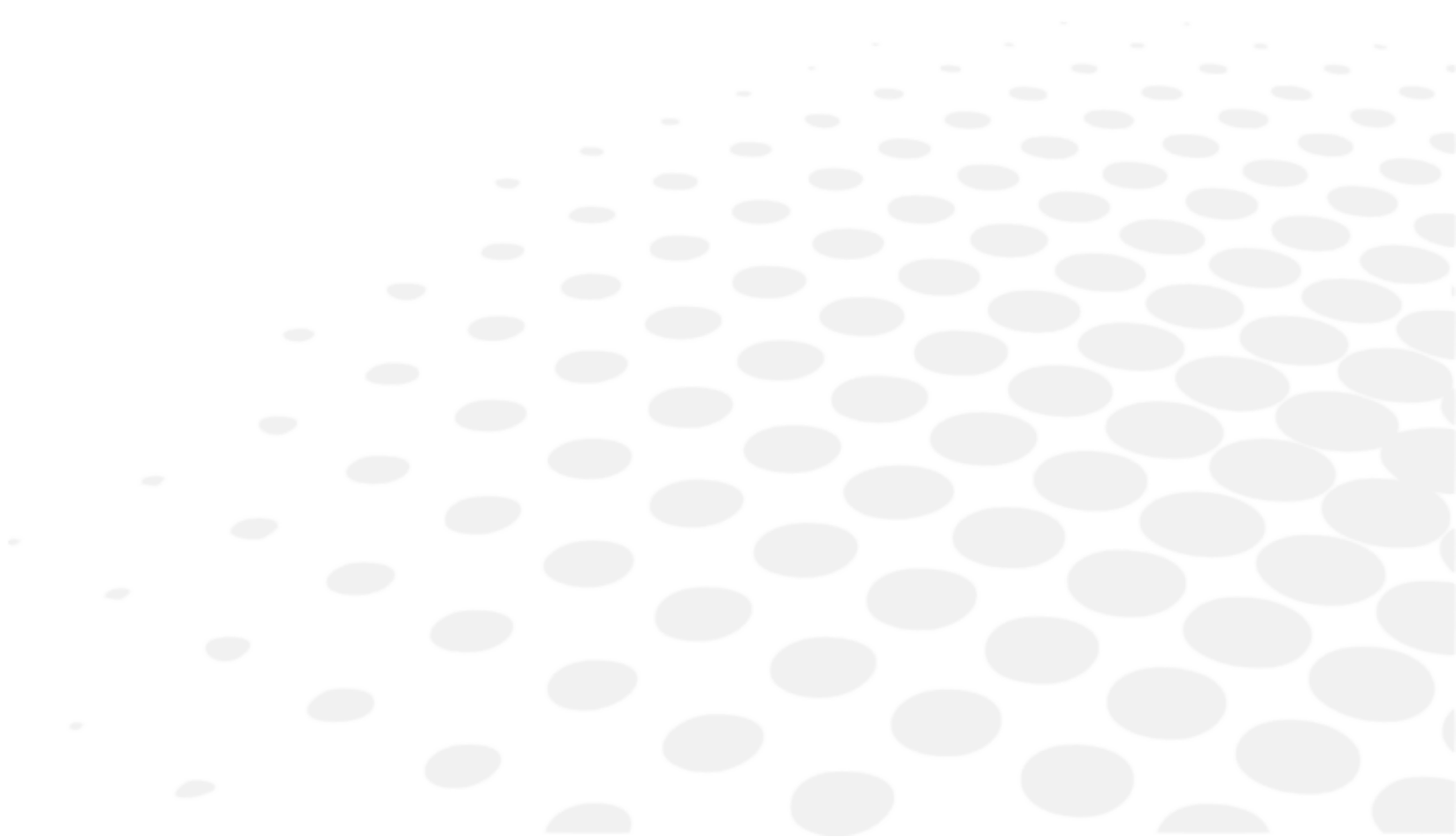





Any serious incident that has occurred in relation to the device should be reported to the manufacturer and the competent authority of the Member State in which the user and/or patient is established.

Vision-R™ 800 is a class I and B-type medical instrument.













The instrument is a system that can save, store and share relative information with the patient such as refraction measurements, name or photo. It is the device user's responsibility to comply with patient data confidentiality regulations, applicable on their site.







## 1. Symbols (document, device & packaging)

### a. On the document

| SYMBOL  | DESCRIPTION  |
|---|--|
|  | Caution: a hazardous situation that, if not avoided, could result in minor or moderate injury. |
|  | Warning: a hazardous situation that, if not avoided, could result in death or serious injury.  |
|  | Danger: a hazardous situation that, if not avoided, will result in death or serious injury.    |
|  | Important and/or useful additional information to learn relating to the text in this manual.   |
|  | Tips: practical advice.  |

### b. On the device and packaging

| SYMBOL  | DESCRIPTION   |
|---|---|
|  | Alternate current   |
|  | D.C. current  |
|  | Applied, type B parts.  |
|  | Manufacturer  |
|  | Manufacturing date (year)   |
|  | Stand by mode   |
|  | CE Marking (European regulation relating to medical devices).                 |
|  | Medical device  |
|  | Compliant to FCC standards  |
|  | Waste disposal symbol in accordance with Directives 2012/19/EU and 2011/65/EU |
|  | ON = Turned-on (power supply connected to the mains)                          |
|  | OFF = Turned-off (power supply disconnected to the mains)                     |
|  | Handle with care  |

|   |  |
|---|--|
|  | This way up  |
|  | Maximum stacking of 4 products above market product  |
|  | Fragile  |
|  | Keep dry   |
|  | Indicate the thermal limits to which the medical device can be exposed in complete safety.                 |
|  | Indicate the humidity limits to which the medical device can be exposed in complete safety.                |
|  | Indicate the limits of atmospheric pressure to which the medical device can be exposed in complete safety. |

## 2. Precautions for use

This device complies with the restrictions imposed by section 15 of the FCC regulation. Its use meets the following conditions: (1) this device must not cause interference and (2) must accept interference from external sources, notably that are liable to cause malfunctions.

Those limits are set so as to ensure reasonable protection against interference in a residential environment. This device generates, uses and can emit radio frequency energy, which may interfere with radio communications if the device is not installed and used in strict conformity with manufacturer instructions. However, there is no guarantee that there will be no interference in certain conditions. You can confirm that this device is the source of interferences with radio or television reception by turning the device on and off.

In accordance with the requirements of FCC rules, any modification made to this equipment which is not expressly approved by the manufacturer would nullify the user's right to use this device.



The intended part of the body applied to the device are: cheeks and front skin are in contact with the device.  
Skin in the contact with the device must be in healthy condition without wounds, irritation or inflammation.



- Essential performances: From regulatory stand point, the product has no essential performance.
- Always handle the refraction head by the upper part, do not hold it or never move it by its moving parts (lower).
- Do not install the instrument next to wireless devices (TV, radio, etc.). The instrument may cause interference.
- Never attempt to dismantle the instrument. This may cause a malfunction or fire.
- If the instrument does not work properly, do not touch the inside. Disconnect the plug from the outlet and consult your dealer.
- To avoid pinching injuries when moving the monitor, please do not put your hand between the monitor and the main unit of the console.
- If liquid spills onto the instrument or foreign objects get inside, unplug the plug from the outlet and consult your dealer.
- If any abnormalities occur (noise, smoke, etc.), unplug the plug from the outlet and consult your dealer. Continued use may result in fire or personal injury.
- The continuous time of usage with one patient should not exceed 70 mins.
- The results and/or technical data resulting from the handling or use of instruments must be analyzed by professionals experienced in various fields of application of the instrument in order to avoid any risk of misreading or incorrect analysis of the data.
- Diagnostics are carried out under the responsibility of the user and Essilor declines any responsibility for the results of these diagnostics.
- The user must use another product before completing the final prescription.
- Do not touch the output connectors (USB, LAN) of the power supply box and the patient simultaneously.
- The presence of fingerprints or dust on the optical parts, for example on the observation windows, affects the accuracy of measurements. It is therefore recommended not to handle them with your fingers and to keep them away from dust. If there are fingerprints or dust on the optical parts, gently wipe them with a soft cloth.
- The covers are fragile, handling them while wearing jewelry or having long nails can lead to scratches.
- The white covers may yellow over time when exposed to ultraviolet light for an extended period.
- When the instrument is not in use, protect it using the cover provided.
- The light emitted from this instrument is potentially hazardous. The longer the duration of exposure, the greater the risk of ocular damage. Patient exposure to light from this instrument when operated at maximum intensity will exceed the safety guideline after 70 minutes.
- There is no limit conditions that the device can tolerate.



- Do not try to repair or modify the instrument.
- Never try to perform any repairs inside the instrument yourself. In the event of malfunctions, consult your dealer.
- To avoid any risk of electrocution, do not open the cover. Consult your dealer for all repairs.

### 3. Contraindication

No contraindications.

### 4. Side effects

No undesirable side-effects.

### 5. Exclusion of liability clause



- The results and/or technical data resulting from the handling or use of instruments must be analyzed by professionals experienced in various fields of application of the instrument in order to avoid any risk of misreading or incorrect analysis of the data.
- Diagnostics are carried out under the responsibility of the user and Essilor declines any responsibility for the results of these diagnostics.

- Each instrument constructed, marketed and/or put on the market directly and/or indirectly by Essilor is designed according to the provisions and the regulations in force. It contains the necessary information to ensure the intended use and permitting the identification of the manufacturer, taking into account the training, experience and knowledge of the intended user.
- This information, including that contained in the accompanying product manuals and the technical advice provided, whether oral, written or communicated during a demonstration, is provided on the basis of best knowledge. However, it must be considered as information without any binding effect, including third-party industrial property rights. It does not exempt the customer from checking current versions, communicated advice and suggestions, particularly the technical safety data sheets, instructions and technical information, as well as assessing the capacity of the instruments to ensure the intended use during delivery.
- The application, use and handling of these instruments as well as the products developed by the customer on the basis of technical consulting and/or maintenance activities are not under the control of Essilor. They are therefore the sole responsibility of the customer. Essilor declines any responsibility in the matter, as indicated below.
- The sale of products is governed by the general conditions of sale and delivery as modified.

## 6. Power source



- **WARNING:** To avoid the risk of electric shock this device must only be connected to a supply mains with protective earth.
- Take care to use the power cord grounding cable when connecting to the ground terminal.
- Do not damage the power cord (by bending it, pulling it or placing heavy objects on top of it, etc.). Do not modify it either. If the cord is damaged (loose contact, damaged sheath, etc.), replace it with a new cord. Continued use may result in an electric shock or fire.
- Do not touch the power plug with wet hands. This may cause an electric shock.
- If you do not use the instrument for an extended period, disconnect the power cord from the outlet.



- Do not use multi-socket power strips, adapters or extension cords to connect the instrument to the mains.
- Make sure the power cord is fully inserted into both the plug and the instrument. Failure to insert it properly may result in a fire or electric shock.
- Clean the power cord regularly to avoid dust buildup. If the cord is dirty, it may cause a malfunction or fire.
- If the power cord becomes hot after using the instrument, check that it is not dirty. If it is not, replace the power cord with a new one. Continued use may cause malfunction or personal injury.
- Use the instrument with the appropriate supply voltage. Continued use with a supply voltage greater than the rated power may cause malfunction or fire.
- Hold the plug when you insert or remove the power cord.
- Use only the power cord provided with the device, model H05VV-F cord type 3G 10 mm<sup>2</sup>, provided with VIIG plug. SJT 3x18 AWG provided with hospital grade plug Nema 5-15P HF for US/CAN ; 2 m in length.

## 7. Precautions regarding IT Network



- This instrument can transfer data to a computer or other devices via a USB or RJ45 interface. These devices must comply with the standard IEC 62368-1. Purpose is to refraction data.
  - IT Network must be parametered in order to accept the text file from product address (firewall parameters)
  - Transfer routines are compliant with FTP protocols.
  - No hazardous situation was reported through product design risk analysis.
  - External equipment intended for connection to signal outputs on the device shall comply with the relevant product standard for such equipment IEC 62368-1 for IT-equipment. In addition, all such combinations – Medical Electrical Systems – shall comply with the requirements stated in clause 16 of IEC 60601-1. Any equipment not complying with the leakage current requirements in IEC 60601-1 shall be kept outside the patient environment (at least 1.5 m from the patient support or shall be supplied via a Separation transformer to reduce the leakage currents).
- Any person who connects external equipment to the device has formed a Medical Electrical System and is therefore responsible for the system to comply with the requirements in clause 16 of IEC 60601-1. If in doubt, contact qualified medical technician or your local representative.
- A Separation Device (isolation device) is needed to isolate the equipment located outside the patient environment from the equipment located inside the patient environment. In particular such a Separation Device is required when a network connection is made. The requirement for the Separation Device is defined in clause 16.5 of IEC 60601-1.
- Connecting this instrument to a computer network that includes other equipment may result in safety and data protection risks.
- The responsible organization is expected to identify, analyze, evaluate and control these risks.
- Any subsequent changes to the computer network may cause risks and require further analysis.
- These changes include:
  - changing the configuration of the computer network;
  - connection of additional devices to the computer network,
  - disconnection of elements of the computer network,
  - updating the equipment connected to the computer network;
  - upgrading the equipment connected to the computer network.

Please contact your distributor for detailed information on this instrument.

## 8. Electromagnetic compatibility



All of the information listed below is based on normative requirements to which manufacturers of electro-medical devices are subject, as defined in the IEC60601-1-2 Ed4 standard.

The device complies with the applicable electromagnetic compatibility standards, however, the user must ensure that any electromagnetic interference does not create an additional risk, such as radio frequency transmitters or other electronic devices.

In this chapter you will find information necessary to ensure that your device is installed and put into service in the best conditions in terms of electromagnetic compatibility. The device's different cords must be separated from each other.

Certain types of mobile telecommunications devices such as mobile phones may interfere with the device. Recommended separation distances must therefore be respected.

The device shall not be used in the vicinity of or placed on another device. If this cannot be avoided, it is necessary to check its proper functioning under the conditions of use before using it. The use of accessories other than those specified or sold by the manufacturer as replacement parts may result in an emissions increase or a decrease in the immunity of the device.

In case the device stop working, reset the device, restart test from the beginning, do not use the previous data for make prescription.

### a. Length of cables, cords, etc.



The length of cables or cords must be greater than 3 meters.

| TYPE OF TEST  | IN ACCORDANCE WITH |
|---|--------------------|
| RF emission   | CISPR 11, Class A  |
| Harmonic current emission                                   | IEC 61000-3-2      |
| Voltage fluctuations and flickering                         | IEC 61000-3-2      |
| Immunity to electrostatic discharge                         | IEC 61000-4-2      |
| Radiated Immunity - Electromagnetic Fields                  | IEC 61000-4-3      |
| Immune to electrical fast transients and bursts             | IEC 61000-4-4      |
| Shock-wave immunity   | IEC 61000-4-5      |
| Conducted radio frequency disturbance immunity              | IEC 61000-4-6      |
| Radiated Immunity - Magnetic Fields                         | IEC 61000-4-8      |
| Immunity to voltage dips, brief cuts and voltage variations | IEC 61000-4-11     |

### b. Recommended separation distance



The device is intended for use in a electromagnetic environment in which RF radiation disturbances are controlled.

The user or installer of the device can help avoid electromagnetic interference by maintaining a minimum distance, depending on the maximum power of the radio frequency transmission equipment. Portable RF communications devices (including devices such as antenna cables and external antennas) must not be used closer than 30 cm (12 inches) to any part of the device, including cables specified by the manufacturer. Otherwise, the performance of these devices could be affected.

### c. Electromagnetic emissions



This product is intended for use in the electromagnetic environment specified below. It is up to the customer or the user to verify that the instrument is used in this environment.

| EMISSIONS TEST  | COMPLIANCE          | ELECTROMAGNETIC ENVIRONMENT – GUIDELINES  |
|---|---------------------|---|
| Electromagnetic radiation disturbance (Radiated Emissions) (CISPR 11) | Group 1             | The product uses RF energy for internal functions.  |
| Disruptive voltage at power stations (Conducted emissions) (CISPR 11) | Class B             | The product may be used in all establishments, including domestic sites and those connected directly to the public low-voltage power. |
| Harmonic current emission (IEC61000-3-2)                              | Class A<br>Complies |   |
| Voltage variations, voltage fluctuations and flicker (IEC61000-3-3)   | Complies            |   |

### d. Magnetic and electromagnetic immunity



The product is intended for use in the electromagnetic environment specified below. It is up to the customer or the user to verify that the instrument is used in this environment.

| IMMUNITY TEST  | TEST LEVEL IEC 60601 & COMPLIANCE LEVEL                      | ELECTROMAGNETIC ENVIRONMENT – GUIDELINES           |
|--|--|--|
| Electrostatic discharge (ESD) (IEC61000-4-2)         | ± 8 kV contact<br>± 15 kV air                                | Environment of a professional healthcare facility. |
| Electrical fast transients and bursts (IEC61000-4-4) | ± 2 kV for power supply lines<br>± 1 kV for the signal ports |  |
| Shock Waves (IEC61000-4-5)                           | ± 2 kV in differential mode<br>± 1 kV in current mode        |  |

|  |   |  |
|--|---|--|
| Assigned industrial frequency magnetic field (IEC61000-4-8)              | 30 A/m  |  |
| Voltage dips, short interruptions and voltage variations (IEC61000-4-11) | 0% $U_T$ for 0.5 cycles<br>(0°, 45°, 90°, 135°, 180°, 225°, 270° and 315° for 0.5 cycle)<br>0% $U_T$ for 1 cycle<br>70% $U_T$<br>For 25 cycles at 50 Hz<br>For 30 cycles at 60 Hz<br>Single phase: 0° | Environment of a professional healthcare facility. If using the system requires continued operation during power cuts, it is recommended that the medical device be supplied with a separate power source (UPS, etc.). |
| Voltage Interruptions (IEC61000-4-11)                                    | 0% $U_T$ for 250 cycles at 50Hz for 300 cycles at 60Hz  |  |



$U_T$  is the AC mains voltage before applying the test level.

### e. Electromagnetic immunity, radio frequencies



The product is intended for use in the electromagnetic environment specified below. It is up to the customer or the user to verify that the instrument is used in this environment.

Portable RF communications devices (including devices such as antenna cables and external antennas) should not be used closer than 30 cm (12 inches) to any part of the device under test, including cables specified by the manufacturer. Otherwise, the performance of these devices could be affected.

| IMMUNITY TEST   | TEST LEVEL IEC 60601 & COMPLIANCE LEVEL  | ELECTROMAGNETIC ENVIRONMENT – GUIDELINES |
|---|--|--|
| Electromagnetic fields radiated radio frequency (IEC61000-4-3)                                | 3 V/m<br>80 MHz to 2.7 GHz<br>80% MA at 1 kHz  | Occupational healthcare facility.        |
| Proximity Fields emitted by RF Wireless Communications Devices (IEC 61000-4-3 Interim Method) | V/m<br>710 MHz, 745 MHz,<br>780 MHz, 5240 MHz,<br>5550 MHz, 5785 MHz,<br>27 V/m<br>385 MHz<br>28 V/m<br>450 MHz, 810 MHz,<br>870 MHz, 930 MHz,<br>1720 MHz, 1845 MHz,<br>1970 MHz, 2450 MHz, |  |
| Field-induced conducted disruptions RF (IEC610004-6)  | 3 V<br>150 Khz to 80 MHZ<br>6 V in ISM frequency and band between 0.15 MHz and 80 MHz, amateur radio frequency including 80% MA at 1 KHz   |  |

# XIII. TROUBLESHOOTING

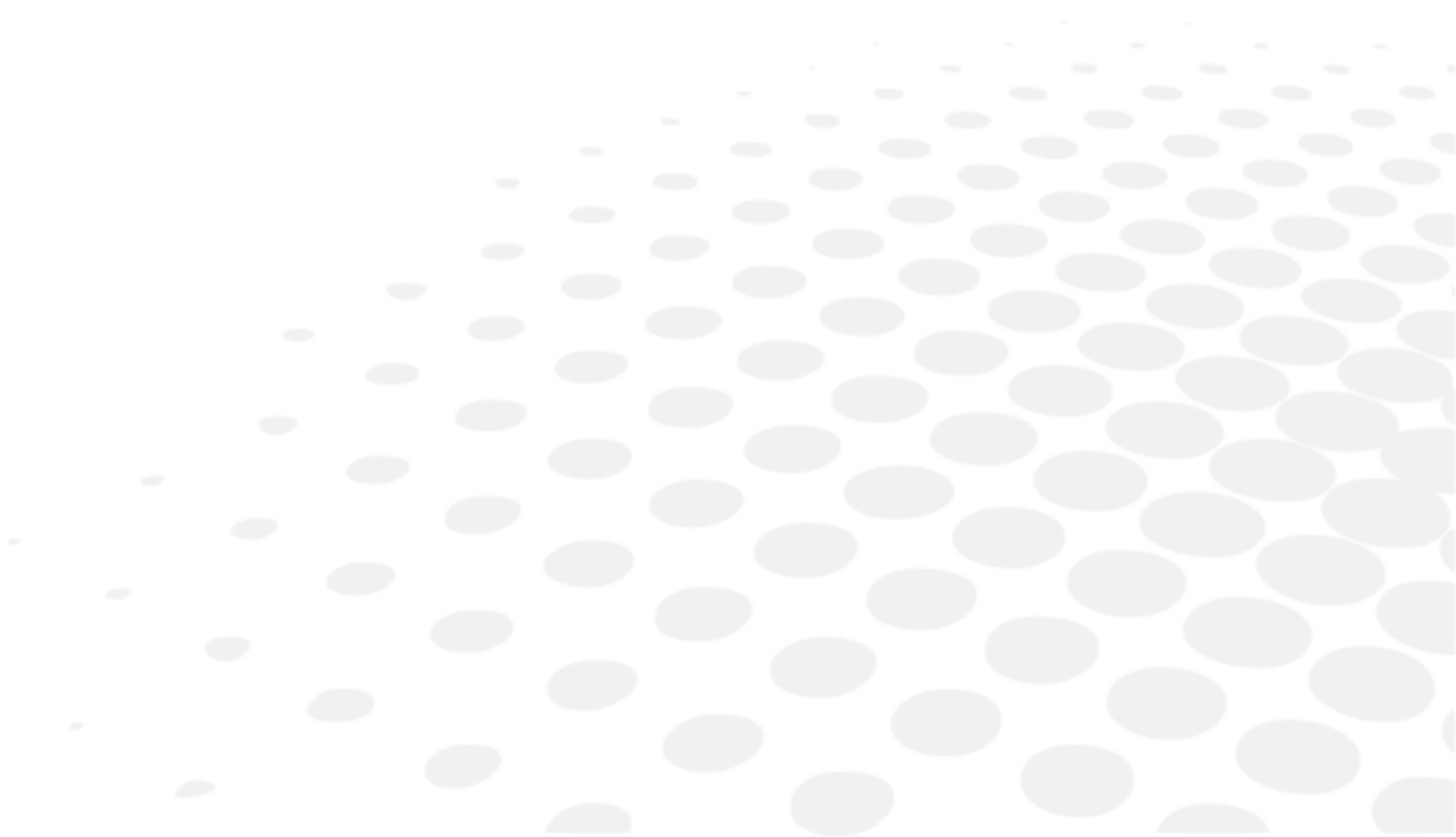

If a problem is detected, refer to the table below in order to take the appropriate measures.

| SYMPTOMS   | CAUSES AND MEASUREMENTS  |
|--|--|
| The refraction head does not initialize itself                       | <ul style="list-style-type: none"> <li>• No power               <ul style="list-style-type: none"> <li>◦ Check that the USB cable connected to the power supply is connected (cable + extension)</li> <li>◦ Check that the power supply block is on</li> </ul> </li> </ul>   |
| The console does not initialize itself                               | <ul style="list-style-type: none"> <li>• No power               <ul style="list-style-type: none"> <li>◦ Check that the power supply block is on</li> <li>◦ Check that [Bluetouch] is on</li> <li>◦ Press on the [Clear] key to start initialization</li> </ul> </li> </ul>  |
| No supply to the power supply box                                    | <ul style="list-style-type: none"> <li>• No power               <ul style="list-style-type: none"> <li>◦ Check that the [ON/OFF] switch is set to ON</li> <li>◦ Check that the first LED on the power supply box is on</li> </ul> </li> </ul>  |
| Frozen console screen  | <ul style="list-style-type: none"> <li>• No power               <ul style="list-style-type: none"> <li>◦ Check mains lead is connected</li> <li>◦ Turn the console off with the [Clear] switch and restart the product</li> </ul> </li> </ul>  |
| Rainbow on the screen  | <ul style="list-style-type: none"> <li>• Video cable error               <ul style="list-style-type: none"> <li>◦ Check that the console cable is plugged into the power supply block</li> </ul> </li> </ul>   |
| Keyboard screen does not switch on and stays black when initializing | <ul style="list-style-type: none"> <li>• Bluetouch lights up               <ul style="list-style-type: none"> <li>◦ Change the cable from console or change the power supply</li> </ul> </li> <li>• Bluetouch does not lights up               <ul style="list-style-type: none"> <li>◦ Change the power supply</li> </ul> </li> <li>• Bluetouch lights up then turns OFF               <ul style="list-style-type: none"> <li>◦ Change the console or change the refraction head</li> </ul> </li> </ul> |

If the problem has not been resolved after taking the measures listed above, contact your local distributor immediately. Your dealer has been trained by Essilor.

# XIV. MAINTENANCE

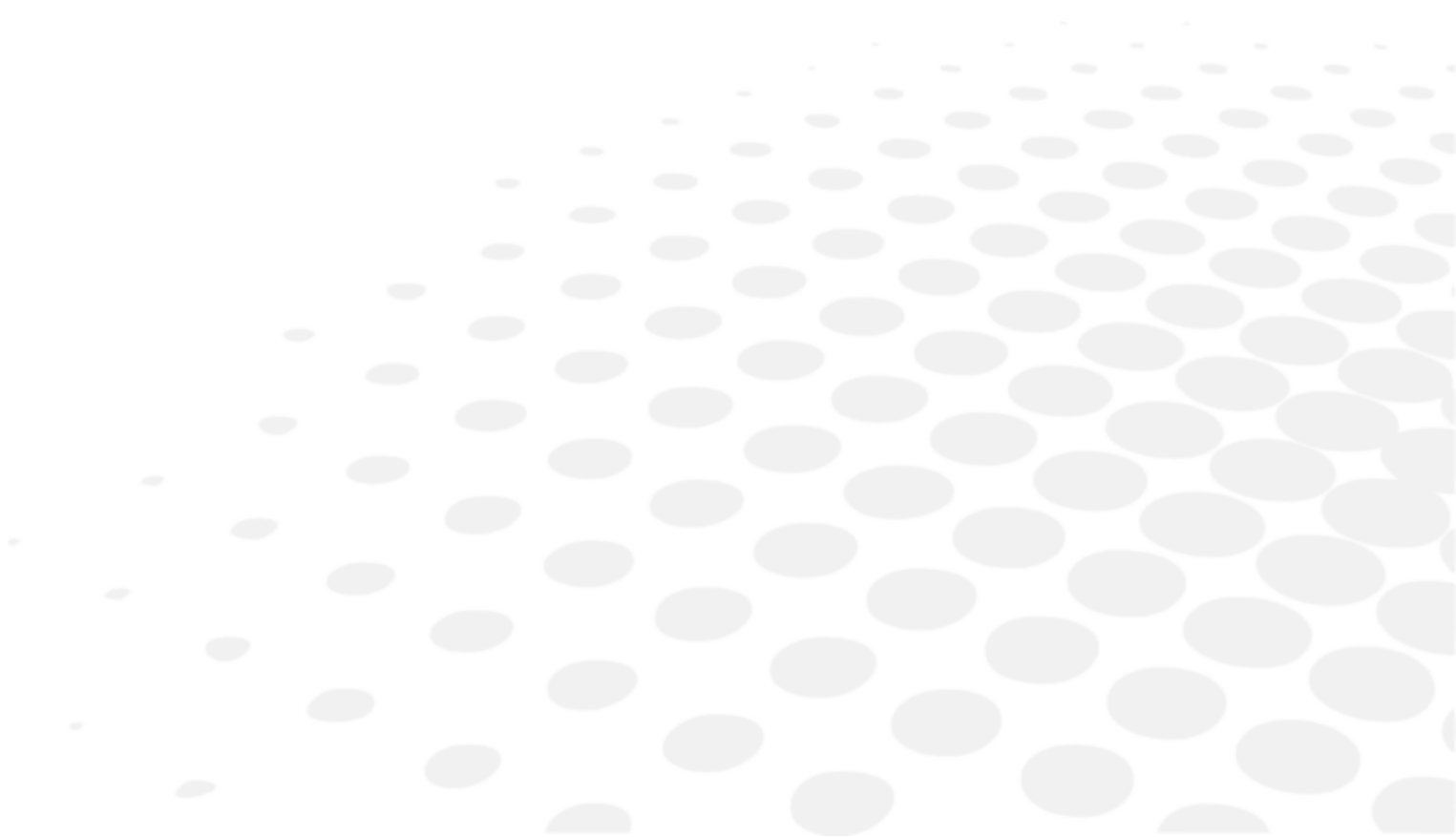



- In order to ensure safety and the performance of the instrument, all maintenance operations, unless otherwise specified in this manual, must be carried out by qualified maintenance technicians.
- This instrument is a high precision optical device. Handle it carefully at all times.
- Take care to handle the instrument carefully in order to avoid any scratches (covers for example).
- Do not touch the optical parts (the observation window for example) with your fingers, and take care to clean off any dust buildup which would be likely to distort the result of measurements.
- If you find that this device is dirty, you can clean it as often as you want (see after the specific cleaning methods).
- Do not use benzene, thinners, organic solvents, ether or gasoline to clean the instrument.

## 1. Storage and handling condition



Respect the operating, storage and transport conditions noted below.

Avoid condensation conditions.

|           | Temperature      | Humidity     | Atmospheric pressure |
|-----------|------------------|--------------|----------------------|
| Use       | [+15°C; +30°C]   | [30 %; 90 %] | [800 hPA; 1060 hPA]  |
| Storage   | [- 10°C; + 55°C] | [10 %; 95 %] | [700 hPA; 1060 hPA]  |
| Transport | [- 40°C; + 70°C] | [10 %; 95 %] | [700 hPA; 1060 hPA]  |

## 2. Cleaning



To avoid any incident, unplug the instrument before cleaning.

Essilor will make available on request circuit diagrams, component part lists, descriptions, calibration instructions, or other information that will assist the dealer to repair those parts of this device that are designated by ESSILOR as repairable by the dealer.

### a. Cleaning and disinfection the head



- To disinfect the areas likely to be in contact with the patient (face shields and forehead rest cover), use disinfectant wipes for medical use.
- Disinfect these areas between testing each patient.



Always use a slightly damp soft cloth (microfiber, silicone), to clean the elements of the head:

- The face shields by removing them beforehand
- The optics
  - patient side (only if a trace is identified)
  - practitioner side
- The camera window for near-vision distance measurements
- The camera windows for Vertex distance measurements
- The LED panel

Do not clean the observation windows (patient side) with liquid, nor with a compress held in a clamp or a screwdriver to prevent damage of the optical surfaces.



To clean the SCV modules (patient side observation windows):

The SCV modules need to be checked after each patient. Visually check if traces of dirt are present on the rear window of the SCV module (patient side).

1. Take one of the cleaning swab (provided with the product).
    - > Change the cleaning swab for the second module.
  2. Spray Isopropyl alcohol (cleaner, antiseptic and disinfectant) on the tip (white part) of the cleaning swab.
    - > Do not dip or soak the cleaning swab directly in alcohol.
  3. Fold the nozzle, in order to have a larger cleaning surface.
  4. Apply the tip in the center of the module and clean the module with a circular motion (snail types).
    - > Spiral movement from the center to the outside of the module.
- Do not use wipe
  - Do not use a tool to clean (screwdriver, pen tip)
  - Do not clean directly with your fingers

### b. Cleaning the console



Always use a slightly damp soft cloth (microfiber, silicone), to clean the elements of the console:

- The touch screen
- The keyboard

Do not spray liquid on the touch screen or the keyboard of the console, regardless of the liquid, in order not to risk damaging the electronic boards.

## 3. Periodical inspection and maintenance



- Inspect the instrument (once a week) to ensure that it is assembled correctly and the console is properly connected.
- Check the tightening of the M6 screw that attaches the head to the phoropter arm.
- Check the tightening of the M5 safety screw (through screw in the phoropter arm).
- If the cover is dirty, gently wipe it with a soft, slightly damp cloth. Wipe any stubborn stains with a little water or neutral detergent.

M6 screw (located above)



M5 screw (located below)



## 4. Disassembly of the product and transport



1. Clear the session then, unplug the instrument.
2. Remove the support rod and near-vision card from the refraction head.
3. Put the forehead rest as close to the refraction head side as possible.
4. Place the arm in the same orientation as the refraction head.
5. Loosen the M5 screw (safety screw) then the M6 screw (attachment screw).

## 5. Disposal



Instructions for the disposal of the instrument in accordance with Directives 2012/19/EU and 2011/65/EU regarding the limitation of dangerous substances in electrical and electronic equipment and the disposal of electrical and electronic waste.

When it reaches the end of its lifetime, the instrument should not be thrown out with the household refuse. It can be disposed of at a waste management center operated by the municipality or the retailers who offer this service.

The separate disposal of an electrical device avoids any damage to the environment or health that could result from a non-compliant disposal, and also allows the materials it is composed of to be recycled in order to save energy and resources.

The pictogram of the wheeled container appears on the label of the instrument. It indicates the obligation for separate collection and disposal of end-of-life/out-of-use electrical and electronic equipment.



- The user must take into account the potentially harmful effects on the environment and human health that could result from the non-compliant disposal of the instrument in its entirety or some of its components.
- To avoid the release of dangerous substances into the environment and to encourage the preservation of natural resources, the manufacturer facilitates, in the event that the user wishes to dispose of the instrument at the end of its lifespan, the reuse, recovery and recycling of the instrument and its components. Before disposing of the instrument, the requirements of European and national regulations must be taken into consideration.
- Do not dispose of the instrument with household waste, but dispose of it separately by giving it in a company specialized in the disposal of electrical and electronic equipment or at the local administrative services in charge of waste collection.
- The supplier or manufacturer is required to recover the old equipment.
- By joining a consortium for the waste of technological equipment, the manufacturer covers the treatment and recycling costs of the used instrument.
- The manufacturer undertakes to provide the user with all the information relating to the dangerous substances contained in the device and the methods of recycling these substances, and to inform them of the existence of recycling of the used equipment. The law provides for severe penalties in case of infringement.

# XV. SPECIFICATIONS

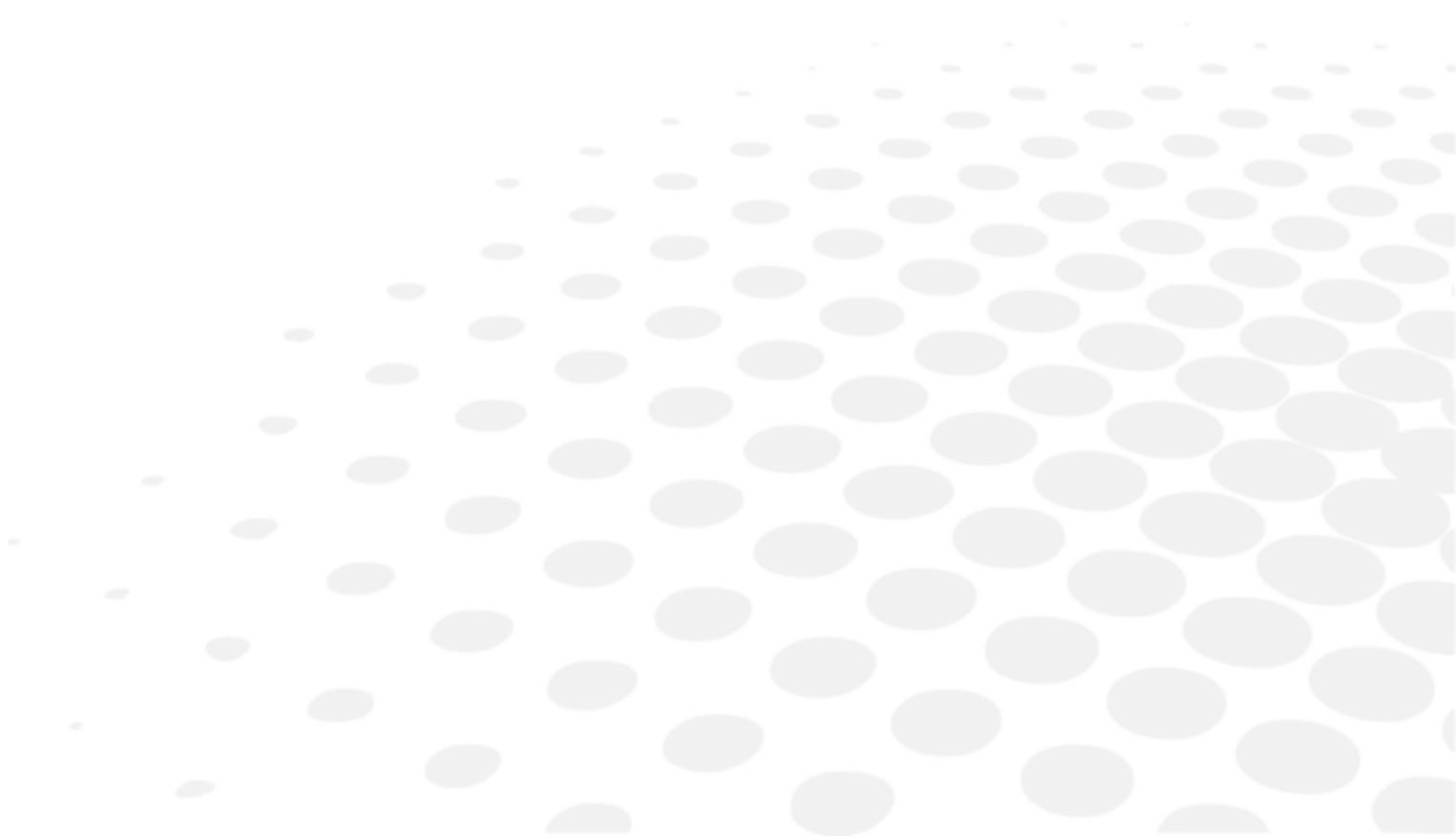

## 1. Technical data

The expected life of the device and its components is 7 years.

### a. Centering

- Interpupillary distance:
  - 49.0 to 80.0 mm at far distance (in 0.50 mm steps)
  - 55.0 to 83.0 mm at near distance (in 0.50 mm steps)
- Binocular and monocular adjustments
- Convergence: automatic, compared to the position of the target for near vision and to the patient's pupillary distance
- Vertex distance: from 4.0 to 30.0 mm in 0.1 mm steps, monocular, measured by cameras

### b. Measurement range

- Sphere: from -20.00 D to +20.00 D
- Cylinder: up to 8.00 D depending on the lens combination. Cylinder from -7.00D to 8.00D with sphere at 0 D
  - In "Standard" mode: 0.25 D increments with adjustable steps
  - In "Intelligent" mode: 0.01 D increments, round to 0.05 D or 0.25 D
- Axis: 0° to 180° in 1° increments, with adjustable steps
- Prism: 0 to 20 Δ in 0.1 Δ increments, with adjustable steps

### c. Auxiliary lenses

- Occluders: dark
- Pin hole: yes
- Retinoscopic lenses: +1.50 D, +2.00 D (powered by optical module)
- Fog lenses: +1.50 D, +2.00 D (powered by optical module)
- Jackson cross cylinders: +/- 0.25 D, +/- 0.50 D (powered by optical module)
- Fixed cross cylinders: +/- 0.50 D (powered by optical modules)
- Prisms: 3 Δ base up / 3 Δ base down, 6 Δ base up, 10 Δ base in (powered by varying prisms / diasporameters)
- Maddox rods: red, horizontal and vertical
- Red/Green filters: red on right eye, green on left eye
- Polarized filter: both linear and circular

### d. Dimensions and weight

- Refraction head:
  - Width: 29.6 cm at top - 21.9 cm at bottom / height= 22.2 cm
  - Depth: 8.4 cm at top - 6.5 at bottom
  - Total weight: 3.5 Kg
- Console (keyboard + screen):
  - Keyboard: 28 x 22 cm
  - Screen display: 10.4"
  - Total weight: 3.0 Kg

- Power supply:
  - Length: 16.3 cm
  - Width: 19.3 cm
  - Depth: 5.8 cm
  - Total weight : 1.0 Kg

## e. LEDs

---

- Near-vision lighting:
  - Colour: white, neutral
  - Chromaticity CCT: 4000 K
  - Flux: 93.9 lm
  - Class: NC
- Visible white LED (Vertex distance):
  - Colour: sunrise
  - Chromaticity CCT: 2700 K
  - Flux: 8 lm to 120°
  - Class: NC
- Infra-red LED:
  - Color: IR
  - Wavelength: 850nm
  - Energy intensity: 50mW/Sr
  - Class: NC
- Infra-red LED (call up tests display on screen):
  - Color: IR
  - Wavelength: 940 nm
  - Energy intensity: 145mW/Sr
  - Class: NC

## f. Input/Output

---

- Power supply box:
  - AC input 100-240V; 50/60 Hz; 1,2-0,5A
  - DC output: 24V
  - Power output: 48 VA
- Refraction head: AC input 24V, 48VA
- Console: AC input 24V, 48VA

## 2. Connectivity to other devices

This section is not applicable.

## 3. It requirements

This section is not applicable.

**XVI. ANNEX**

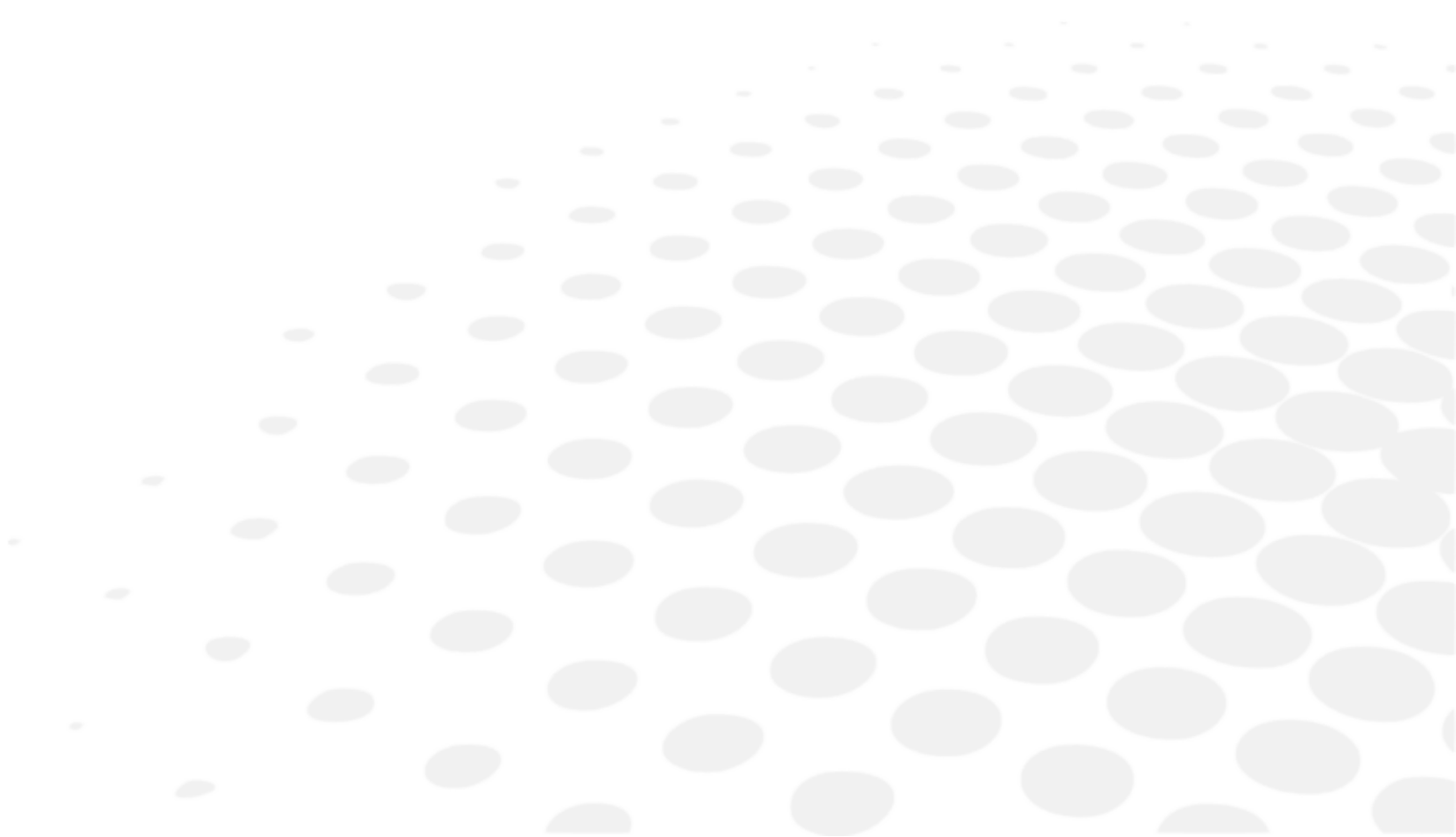

## 1. Frequently Asked Questions

### a. What is the point of determining the refraction with a precision of 0.01 D?

The refraction has always been carried out with steps of 0.25 D leading to prescriptions that are only a good estimate of the patient's needs. The use of increments of 0.01 D during the refraction process provides patients with their exact or most appropriate prescription in 0.25 D.

In traditional refraction procedures, values are rounded to 0.25 D at each stage of the procedure (sphere, cylinder, binocular balance, binocular confirmation) and inaccuracies accumulate. In the end, the prescriptions are not completely accurate.

In the Vision-R 800 refraction procedure, the entire test is performed using steps of 0.01 D to determine the exact refraction of the patient. Patients can then be offered their exact prescriptions with precise lenses or their best reliable prescription with traditional 0.25 D lenses.

With Vision-R 800, practitioners can be sure to measure the exact prescription at 0.01 D or the most appropriate refraction at 0.25 D and decide on prescriptions accordingly.

### b. Can patients really notice refraction changes below 0.25 D?

Yes, patients notice less than 0.25 change D.

In a study of 146 patients by the Essilor research team, it was shown that 95% of patients are sensitive to variations of less than 0.125 D for at least one type of test during the eye examination.

Furthermore, it has been shown that refraction does not vary significantly in human eyes: measured under the same conditions, the refraction does not change significantly within a few days: in a study conducted by Essilor researchers, the median value of the variation was measured at 0.13 D for the sphere and 0.07 D for the cylinder.

It is therefore interesting to offer patients their exact prescription and, thus, the best of their vision.

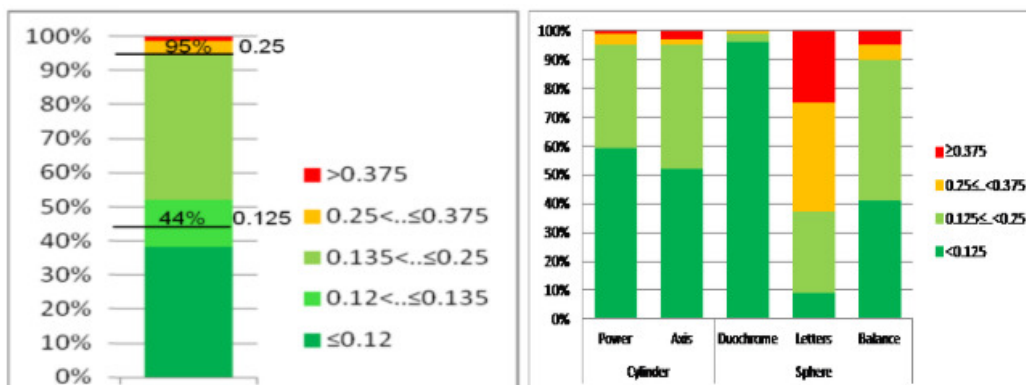

Patient sensitivity to dioptric changes in refraction components, measured in the refraction process in 146 patients.

## XVII. QR CODE

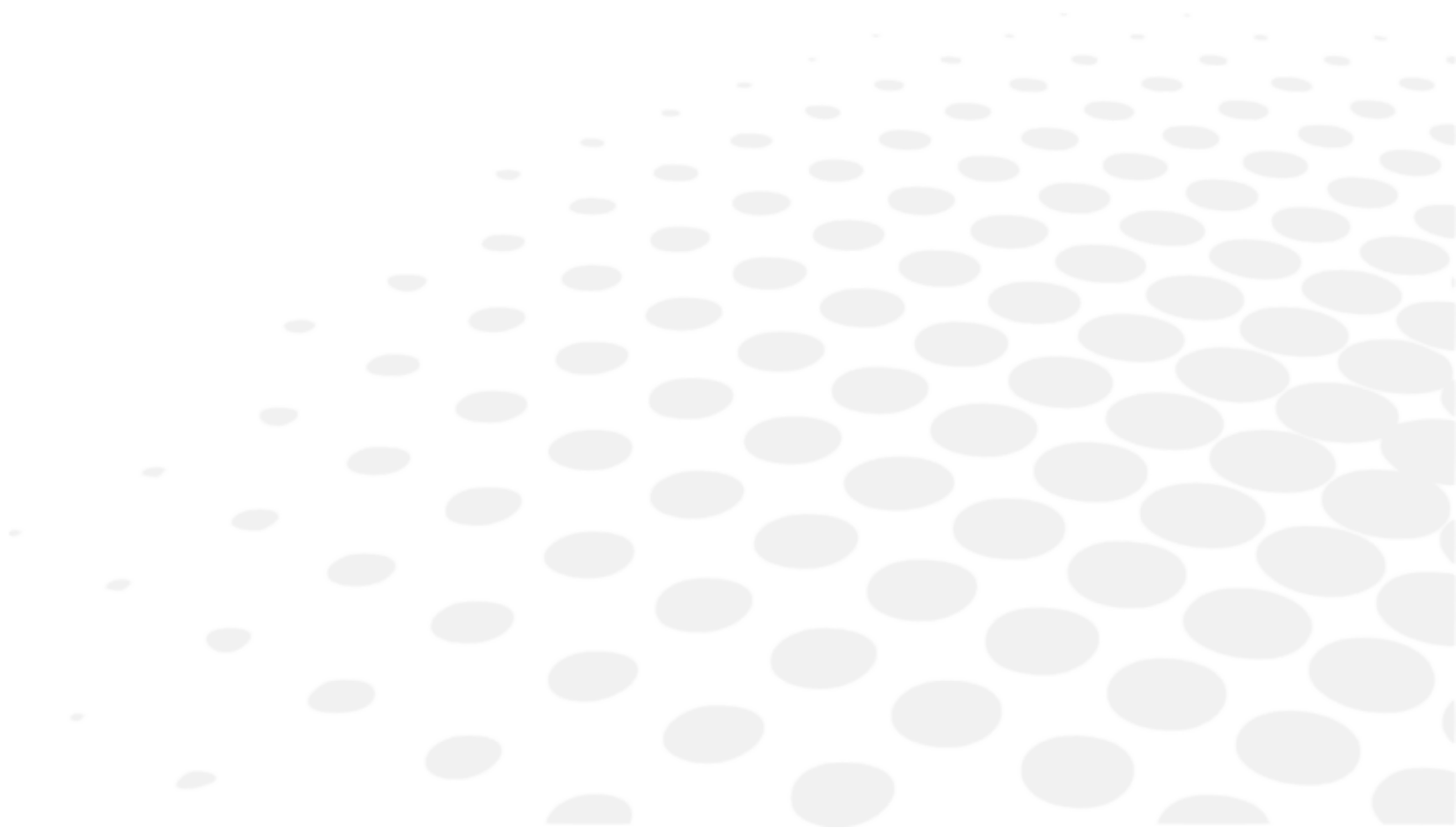



The latest version of the user manual in the appropriate language is available on a web space. Upon request, a paper version can be provided for free.



The complete user manual is available on a web space. To access it, please scan the QR code below using a dedicated application.



Le manuel utilisateur complet est disponible sur un espace web. Pour y accéder veuillez scanner le QR code ci-dessous à l'aide d'une application dédiée.



Die vollständige Bedienungsanleitung ist auf einem Speicherplatz verfügbar: Für den Zugriff darauf scannen Sie bitte untenstehenden QR-Code mittels einer dafür vorgesehenen Anwendung.



O manual do usuário completo está disponível na área web do cliente. Para acessar, escaneie o código QR abaixo usando o aplicativo respectivo.



Пълното ръководство за потребителя е достъпно на уеб пространство. За достъп, моля, сканирайте QR кода по-долу с помощта на специално предназначено приложение.



Potpuni korisnički priručnik dostupan je na webu. Da biste mu pristupili, skenirajte QR-kod u nastavku namjenskom aplikacijom.



Den komplette brugermanual findes på et websted. Du får adgang til den ved at scanne QR-koden nedenfor ved hjælp af en dertil beregnet applikation.



El manual de uso completo está disponible en la web. Para acceder, escanee el código QR que se encuentra a continuación con la ayuda de una aplicación.



Täielik kasutusjuhend on saadaval veebis. Juurdepääsuks palun skannige allolevat QR-koodi, kasutades selleks spetsiaalset rakendust.



Täydellinen käyttöohje on käytettävissä verkossa. Avaa käyttöohje skannaamalla QR-koodi asianmukaisella sovelluksella.



Το πλήρες εγχειρίδιο χρήσης διατίθεται σε έναν ιστοχώρο. Για να μεταβείτε σε αυτόν, σαρώστε τον παρακάτω κωδικό QR μέσω μιας ειδικής εφαρμογής.



A teljes használati útmutató megtalálható a webes felületen. A hozzáféréshoz, kérjük, olvassa le a lenti QR-kódot a megfelelő alkalmazás használatával.



Il manuale utente completo è disponibile su uno spazio Web. Per accedervi, scansionare il codice QR seguente mediante un'applicazione dedicata.



Pilnā lietotāja instrukcija ir pieejama tīmeklī. Lai tai piekļūtu, lūdzu, noskenējiet tālāk redzamo QR kodu, izmantojot tam paredzētu lietojumprogrammu.



Den komplette brukerhåndboken er tilgjengelig på et webområde. For å få tilgang, må du skanne QR-koden nedenfor ved hjelp av en dedikert applikasjon.



De volledige gebruikershandleiding is beschikbaar op een website. U kunt de handleiding bereiken door de QR-code hiernaast te scannen met een geschikte applicatie.



Kompletna instrukcja użytkownika jest dostępna na stronie internetowej. Aby uzyskać do niej dostęp, zeskanuj poniższy kod QR przy użyciu dedykowanej aplikacji.



O manual do utilizador completo está disponível num espaço web. Para aceder, queira digitalizar o QR code seguinte com a ajuda de uma aplicação dedicada.





Celá uživatelská příručka je k dispozici na webu. Pro přístup k ní oskenujte níže uvedený QR kód pomocí specializované aplikace.

- 

Versiunea integrală a manualului de utilizare este disponibilă pe un site web. Pentru a-l accesa, scanați codul QR de mai jos cu ajutorul unei aplicații dedicate.
- 

Полное руководство пользователя доступно в Интернете. Для доступа просканируйте приведенный ниже QR-код с помощью специального приложения.
- 

Potpuno korisničko uputstvo je dostupno na webu. Da biste mu pristupili, skenirajte QR kôd u nastavku pomoću namenske aplikacije.
- 

Celý používateľský manuál je dostupný na internete. Aby ste sa k nemu dostali, naskenujte QR kód nižšie pomocou na to určenej aplikácie.
- 

Celoten uporabniški priročnik je na voljo na spletnem mestu. Za dostop do njega skenirajte spodnjo kodo QR z uporabo namenske aplikacije.
- 

Den fullständiga handboken finns på en plats på Internet. Skanna QR-koden nedan med en lämplig app för att få åtkomst till den.
- 

Íssamaus naudotojų vadovo ieškokite interneto svetainėje. Kad ji atvertumėte, specialia programėle nuskaitykite toliau pateiktą QR kodą.
- 

Повне керівництво користувача доступно в Інтернеті. Для доступу проскануйте наведений нижче QR-код за допомогою спеціального додатку.
- 

มีคู่มือผู้ใช้ฉบับสมบูรณ์อยู่ในพื้นที่เว็บ เพื่อเข้าถึงข้อมูล กรุณาสแกนรหัส QR ด้านล่างนี้โดยใช้แอปพลิเคชันเฉพาะทาง
- 

可通过网络空间访问操作手册全文·如需访问该空间·请使用专用应用程序扫描QR码·
- 

완전한 사용자 매뉴얼이 웹사이트에 있습니다. 전용 앱을 사용해 아래의 QR 코드를 스캔하면 접근할 수 있습니다.
- 

ユーザーマニュアル完全版はウェブサイト内で閲覧いただけます。そちらにアクセスするには、専用アプリケーションを使用して以下のQRコードをスキャンしてください。
- 

Panduan pengguna yang lengkap tersedia di halaman web. Untuk mengaksesnya, silakan pindai kode QR berikut menggunakan aplikasi khusus.
- 

Manual pengguna yang lengkap boleh didapati di ruangan web. Untuk akses, sila imbas kod QR di bawah menggunakan aplikasi yang berkenaan.
- 

Cẩm nang hướng dẫn sử dụng hoàn chỉnh hiện có trên không gian web. Để truy cập, vui lòng quét mã QR bên dưới bằng ứng dụng chuyên dụng.
- إن الدليل الكامل للمستخدم متاح على استضافة ويب، لتتمكن من الوصول إليه، يُرجى مسح رمز الاستجابة السريعة أدناه باستخدام تطبيق مخصص لذلك الأدبية العربية.
- 

Kullanma kılavuzunun tamamı internette bulunmaktadır. Kılavuza erişmek için, QR kodunu uygun bir uygulama kullanarak taratınız.
- 

Пълната инструкция карыстальніка даступна ў інтэрнэт-прасторы. Каб атрымаць доступ, адсканіруйце QR-код ніжэй пры дапамозе спецыяльнай праграмы.

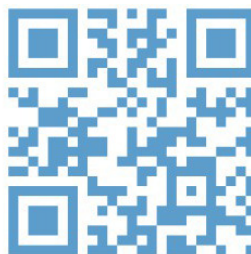



Essilor International

147, rue de Paris – 94220 Charenton-le-Pont France

[www.essilor.com](http://www.essilor.com)